



Getting Started with Kepler

Kepler 1.0.0
May 12, 2008



Getting Started with Kepler

The *Getting Started with Kepler* guide is a tutorial style manual for scientists who want to create and execute scientific workflows.

Table of Contents

1.	Introduction.....	2
1.1.	What is Kepler?.....	2
1.2.	What are Scientific Workflows?.....	4
2.	Downloading and Installing Kepler.....	5
2.1.	System Requirements.....	5
2.2.	Installing on Windows.....	6
2.3.	Installing on Macintosh.....	6
2.4.	Installing on Linux.....	7
3.	Starting Kepler.....	8
3.1.	Windows and Macintosh Platforms.....	8
3.2.	Linux Platform.....	8
4.	Basic Components in Kepler.....	8
4.1.	Director and Actors.....	9
4.2.	Ports.....	10
4.3.	Relations.....	11
4.4.	Parameters.....	11
5.	Kepler Interface.....	11
5.1.	The Toolbar.....	12
5.2.	Components and Data Access Area.....	13
5.3.	Director and Actor Icons.....	14
5.4.	The Workflow Canvas.....	16
6.	Basic Operations in Kepler.....	16
6.1.	Opening an Existing Scientific Workflow.....	17
6.1.1.	Example 1: Opening the Lotka-Volterra Workflow.....	17
6.2.	Running an Existing Scientific Workflow.....	19
6.2.1.	Example 2: Running the Lotka-Volterra Workflow with Default Parameters.....	20
6.2.2.	Example 3: Running the Lotka-Volterra Workflow with Adjusted Parameters.....	21

6.3.	Editing an Existing Scientific Workflow	24
6.3.1.	Example 4: Editing/Substituting Analytical Processes in the Image J Workflow	25
6.4.	Searching in Kepler.....	27
6.4.1.	Searching for Available Data.....	27
6.4.2.	Searching for Available Processing Components.....	29
6.5.	Creating a Basic Scientific Workflow	30
6.5.1.	Example 5: Creating a “Hello World” Workflow.....	30
6.5.2.	Example 6: Creating a Simple Workflow Using Local Data.....	32
7.	Sample Scientific Workflows	33
7.1.	Sample Workflow 1 – Simple Statistics	33
7.2.	Sample Workflow 2 –Linear Regression.....	36
7.3.	Sample Workflow 3 – Web Services and Data Transformation.....	41
7.4.	Sample Workflow 4 – Execute an External Application from Kepler (ExternalExecution actor).....	47
8.	Appendix.....	50
8.1.	Ptolemy II – The Foundation of Kepler.....	50
8.2.	Actor Reference	51

1. Introduction

The Getting Started Guide introduces the main components and functionality of Kepler, and contains step-by-step instructions for using, modifying, and creating your own scientific workflows. The Guide provides a brief introduction to the application interface as well as to application-specific terminology and concepts. Once you are familiar with the general principles of Kepler, we recommend that you work through a couple of the sample workflows covered in Section 7 to get a feel for how easy it is to use and modify workflow components and how components can be combined to form powerful workflows.

1.1. What is Kepler?

Kepler is a software application for the analysis and modeling of scientific data. Kepler simplifies the effort required to create executable models by using a visual representation of these processes. These representations, or “scientific workflows,” display the flow of data among discrete analysis and modeling components (*Figure 1*).

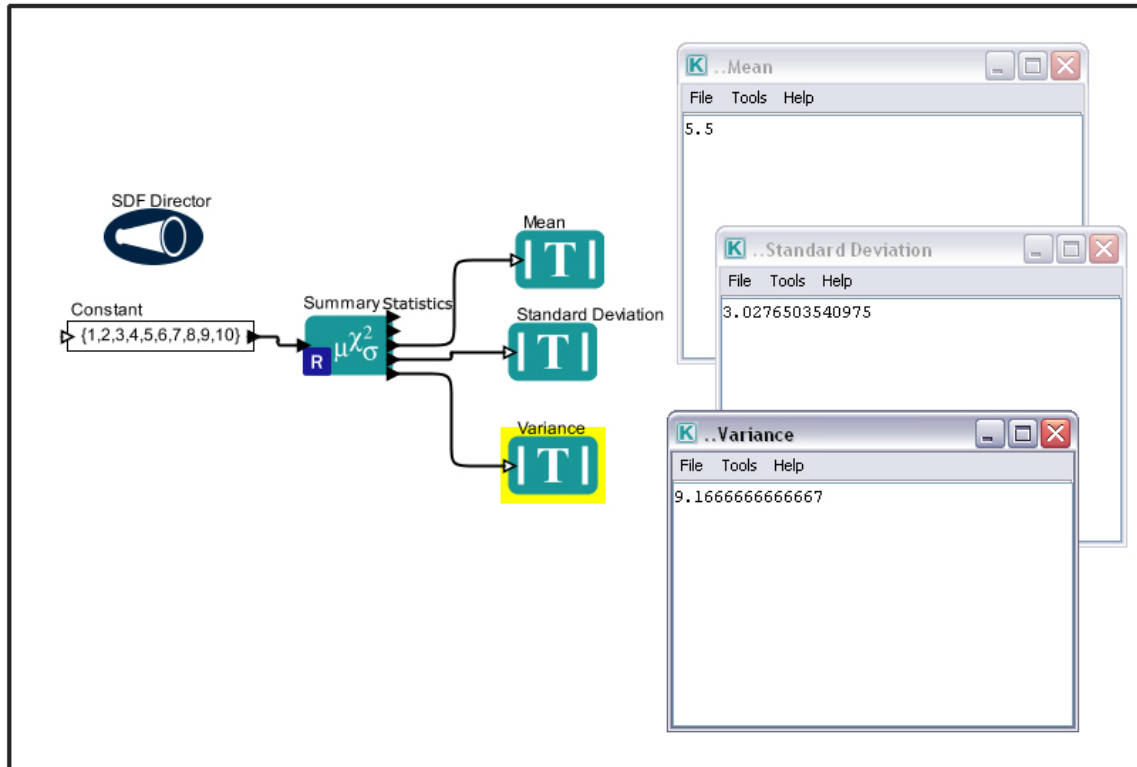

Figure 1: A simple scientific workflow developed in Kepler

Kepler allows scientists to create their own executable scientific workflows by simply dragging and dropping components onto a workflow creation area and connecting the components to construct a specific data flow, creating a visual model of the analytical portion of their research. Kepler represents the overall workflow visually so that it is easy to understand how data flow from one component to another. The resulting workflow can be saved in a text format, emailed to colleagues, and/or published for sharing with colleagues worldwide.

Kepler users with little background in computer science can create workflows with standard components, or modify existing workflows to suit their needs. Quantitative analysts can use the visual interface to create and share R and other statistical analyses. Users need not know how to program in R in order to take advantage of its powerful analytical features; pre-programmed Kepler components can simply be dragged into a visually represented workflow. Even advanced users will find that Kepler offers many advantages, particularly when it comes to presenting complex programs and analyses in a comprehensible and easily shared way.

Kepler includes distributed computing technologies that allow scientists to share their data and workflows with other scientists and to use data and analytical workflows from others around the world. Kepler also provides access to a continually expanding, geographically distributed set of data repositories, computing resources, and workflow libraries (e.g., ecological data from field stations, specimen data from museum collections, data from the geosciences, etc.).

1.2. What are Scientific Workflows?

Scientific workflows are a flexible tool for accessing scientific data (streaming sensor data, medical and satellite images, simulation output, observational data, etc.) and executing complex analysis on the retrieved data.

Each workflow consists of analytical steps that may involve database access and querying, data analysis and mining, and intensive computations performed on high performance cluster computers. Each workflow step is represented by an “actor,” a processing component that can be dragged and dropped into a workflow via Kepler’s visual interface. Connected actors (and a few other components that we’ll discuss in later sections) form a workflow, allowing scientists to inspect and display data on the fly as it is computed, make parameter changes as necessary, and re-run and reproduce experimental results.¹

Workflows may represent theoretical models or observational analyses; they can be simple and linear, or complex and non-linear. One of the benefits of scientific workflows is that they can be nested, meaning that a workflow can contain “sub-workflows” that perform embedded tasks. A nested workflow (also known as a composite actor) is a reusable component that performs a potentially complex task.

Scientific workflows in Kepler provide access to the benefits of today’s grid technologies (providing access to distributed resources such as data and computational services), while hiding the underlying complexity of those technologies. Kepler automates low-level data processing tasks so that scientists can focus instead on the scientific questions of interest.

Workflows also provide the following:

- documentation of all aspects of an analysis
- visual representation of analytical steps
- ability to work across multiple systems
- reproducibility of a given project with little effort
- reuse of part or all of a workflow in a different project

To date, most scientific workflows have involved a variety of software programs and sophisticated programming languages. Traditionally, scientists have used STELLA or Simulink to model systems graphically, and R or MATLAB to perform statistical analyses. Some users perform calculations in Excel, which is user-friendly, but offers no record of what steps have been executed. Kepler combines the advantages of all of these programs, permitting users to model, analyze, and display data in one easy-to-use interface.

¹ See Ludäscher, B., I. Altintas, C. Berkley, D. Higgins, E. Jaeger-Frank, M. Jones, E. Lee, J. Tao, Y. Zhao. 2005. Scientific Workflow Management and the Kepler System, DOI: 10.1002/cpe.994

Kepler builds upon the open-source Ptolemy II visual modeling system (<http://ptolemy.eecs.berkeley.edu/ptolemyII/>), creating a single work environment for scientists. The result is a user-friendly program that allows scientists to create their own scientific workflows without having to integrate several different software programs or enlist the assistance of computer programmers.

A number of ready-to-use components come standard with Kepler, including generic mathematical, statistical, and signal processing components and components for data input, manipulation, and display. R- or MATLAB-based statistical analysis, image processing, and GIS functionality are available through direct links to these external packages. You may also create new components or wrap existing components from other programs (e.g., C programs) for use within Kepler.

2. Downloading and Installing Kepler

Kepler is an open-source, cross-platform software program that can run on Windows, Macintosh, or Linux-based platforms. Kepler can be downloaded from the project website: <http://kepler-project.org>. Kepler 1.0.0 is the most current release.

Kepler releases are a continual work in progress, and Kepler users are encouraged to contribute to the product by suggest new features that would be of use, as well as to notify the designers of bugs and other problems. See <http://www.kepler-project.org/Wiki.jsp?page=GettingInvolved> for more information. Community involvement in the on-going development of Kepler has proved valuable because it allows the system to quickly adapt to the needs of practicing scientists. To stay abreast of changes and updates, subscribe to the Kepler users' mailing list at <http://mercury.nceas.ucsb.edu/ecoinformatics/mailman/listinfo/kepler-users>.

2.1. System Requirements

Recommended system requirements for running Kepler:

- 300 MB of disk space
- 512 MB of RAM minimum, 1 GB or more recommended
- 2 GHz CPU minimum
- Java 1.5.x (do not use Java 1.6)
- Network connection (optional). Although a connection is not required to run Kepler, many workflows require a connection to access networked resources.)
- R software (optional). R is a language and environment for statistical computing and graphics, and it is required for some common Kepler functionality. R is included with the full Kepler installation for Windows and Macintosh; R is not included with Kepler's Linux installer.

To download and install Kepler, follow the instructions for your system. Downloading the installer files may be time consuming depending upon your connection.

NOTE: Java 1.5.x is required and can be obtained from Sun's Java website at: <http://java.sun.com/j2se/downloads/> or from your system administrator. Kepler installers for Windows and Linux will direct you to a page to download and install Java 1.5.x if it is not already installed on your system. Check the installation instructions for your platform for more information.

2.2. Installing on Windows

The Windows installer will install the Kepler application and (optionally) R--a statistical computing language and environment used by a number of Kepler actors--on your system. If you do not have Java 1.5.x installed, the installer will direct you to a page to download and install it. Java 1.5.x is required in order to run the Kepler software.

If R is installed with Kepler, it should not interfere with a previously installed version of R except when one launches R from the command line (by entering 'R'). The Kepler installer updates your system so that the new version of R will be launched from the command line. Existing shortcuts will still open the previously installed R application. The version of R included with the Kepler installer is 2.6.2.

Follow these steps to download and install Kepler for Windows:

1. Click the following link: <http://kepler-project.org/Wiki.jsp?page=Downloads> and select the Windows installer
2. Save the install file to your computer.
3. Double-click the install file to open the install wizard.
4. Follow the steps presented to complete the Kepler installation process.

Once the installation process is complete, a Kepler shortcut icon will appear on your desktop (*Figure 2*) and/or in the Start Menu.



Figure 2: Kepler shortcut icon

2.3. Installing on Macintosh

The Mac installer will install the Kepler application and (optionally) R--a statistical computing language and environment used by a number of Kepler actors--on your system. Java is included as part of the Mac OSX operating system, so it need not be installed.

Because [R](#) is required for some common Kepler functionality, we recommend that users choose to install R with the Kepler installation (the default). If R is installed with Kepler, it should not interfere with a previously installed version of R except when one launches R from the command line (by entering 'R'). The Kepler installer updates your system so that the new version of R will be launched from the command line. Existing shortcuts will still open the previously installed R application. The version of R included with the Kepler installer is 2.6.2.

Follow these steps to download and install Kepler for Macintosh systems:

- 1 Click the following link: <http://kepler-project.org/Wiki.jsp?page=Downloads> and select the Mac install file. Save the install file to your computer.
- 2 Double-click the install icon that appears on your desktop when the extraction is complete.
- 3 Follow the steps presented in the install wizard to complete the Kepler installation process.

A Kepler icon is created under Applications/Kepler. The icon can be dragged and dropped to the desktop or the dock if desired.

2.4. Installing on Linux

The Linux installer will install the Kepler application and, if you do not have Java 1.5.x installed, direct you to a page to download and install it. Java 1.5.x is required in order to run the Kepler software.

R, a language and environment for statistical computing and graphics, is *NOT* included with the Linux installer. Because R is required for some common Kepler functionality, we recommend that users download and install R. For more information about R, see <http://www.r-project.org>.

Follow these steps to download and install Kepler for Linux:

1. Click the following link: <http://kepler-project.org/Wiki.jsp?page=Downloads> and select the Linux install file.
2. Save the install file to your computer
3. Double-click the install file to open the install wizard. We recommend that you quit all programs before continuing with the installation.
4. The Kepler installer displays a status bar as the installation progresses. If Kepler has previously been installed on the system, the installer will overwrite any existing cache files.

3. Starting Kepler

To start Kepler, follow the instructions for your platform.

3.1. Windows and Macintosh Platforms

To start Kepler on a PC, double-click the Kepler shortcut icon on the desktop (*Figure 2*). Kepler can also be started from the Start menu. Navigate to Start menu > All Programs, and select "Kepler" to start the application. On a Mac, the Kepler icon is created under Applications/Kepler. The icon can be dragged and dropped to the desktop or the dock if desired.

The main Kepler application window opens (*Figure 3*). From this window you can access and run sample and existing scientific workflows and/or create your own custom scientific workflow. Each time you open an existing workflow or create a new workflow, a new application window will open. Multiple windows allow you to work on several workflows simultaneously and compare, copy, and paste components between workflows

3.2. Linux Platform

To start Kepler on a Linux machine, use the following steps:

1. Open a shell window. On some Linux systems, a shell can be opened by right-clicking anywhere on the desktop and selecting "Open Terminal". Speak to your system administrator if you need information about your system.
2. Navigate to the directory in which Kepler is installed. To change the directory, use the `cd` command (e.g., `cd directory_name`).
3. Type `./kepler.sh` to run the application.

The main Kepler application window opens (*Figure 2.3*). From this window you can access and run existing scientific workflows and/or create your own custom scientific workflow. Each time you open an existing workflow or create a new workflow, a new application window opens. Multiple windows allow you to work on several workflows simultaneously and compare, copy, and paste components between workflows.

4. Basic Components in Kepler

Scientific workflows consist of customizable components—directors, actors, and parameters—as well as relations and ports, which facilitate communication between the components.

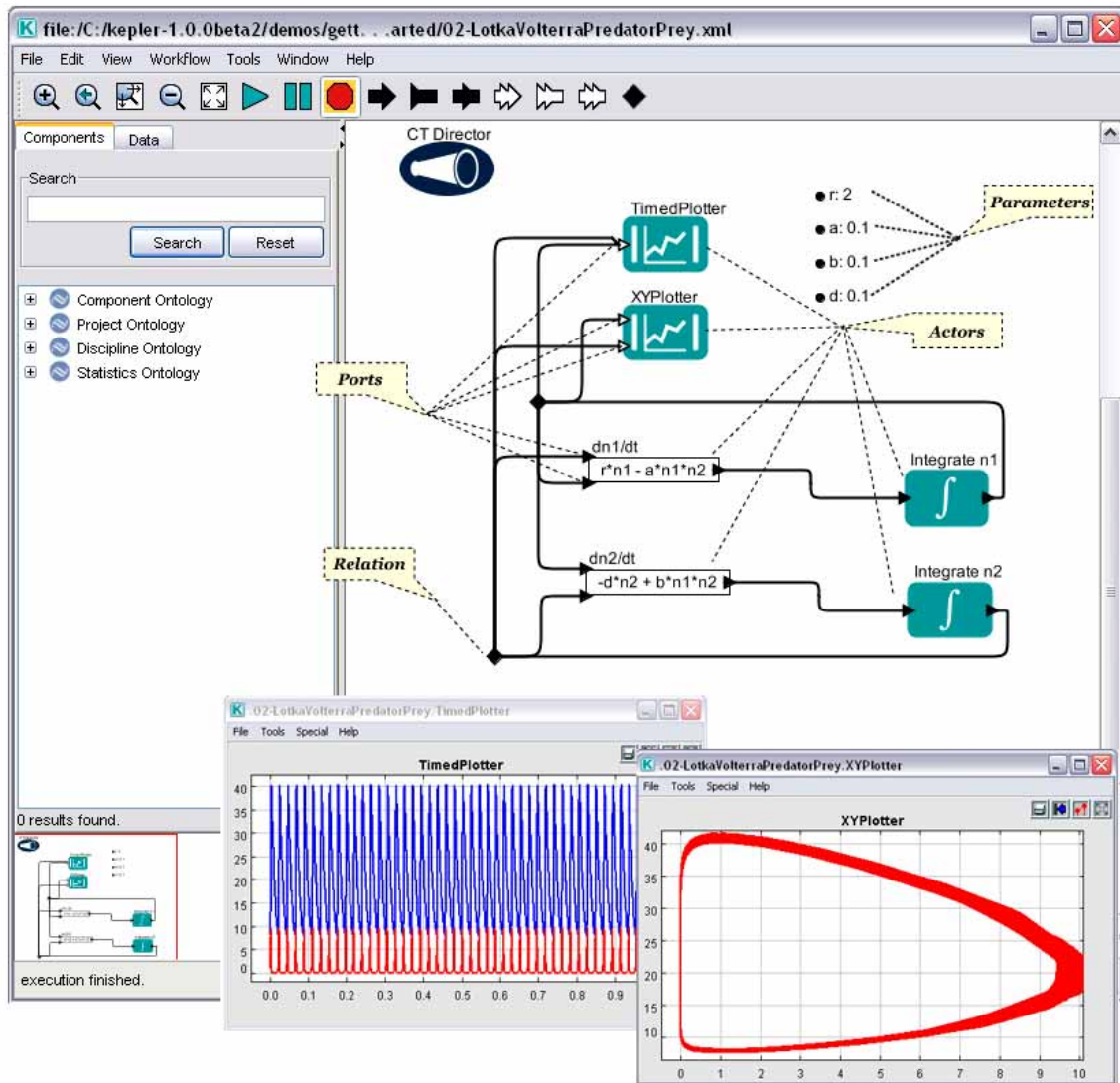

Figure 3: Main window of Kepler with some of the major workflow components highlighted. The windows on the bottom right are output windows, created by the workflow to display result graphs.

4.1. Director and Actors

Kepler uses a director/actor metaphor to visually represent the various components of a workflow. A director controls (or directs) the execution of a workflow, just as a film director oversees a cast and crew. The actors take their execution instructions from the director. In other words, actors specify *what* processing occurs while the director specifies *when* it occurs.

Every workflow must have a director that controls the execution of the workflow using a particular model of computation. Each model of computation in Kepler is represented by its own director. For example, workflow execution can be synchronous, with processing

occurring one component at a time in a pre-calculated sequence (*SDF Director*). Alternatively, workflow components can execute in parallel, with one or more components running simultaneously (which might be the case with a *PN Director*). A small set of commonly used directors come pre-packaged with Kepler, but more are available in the underlying Ptolemy II software that can be accessed as needed. For more detailed discussion of workflow models of computation, please refer to the [Kepler User Manual](#) or the [Ptolemy II](#) documentation.

Composite actors are collections or sets of actors bundled together to perform more complex operations. Composite actors can be used in workflows, essentially acting as a nested or sub-workflow (*Figure 4*). An entire workflow can be represented as a composite actor and included as a component within an encapsulating workflow. In more complex workflows, it is possible to have different directors at different levels.

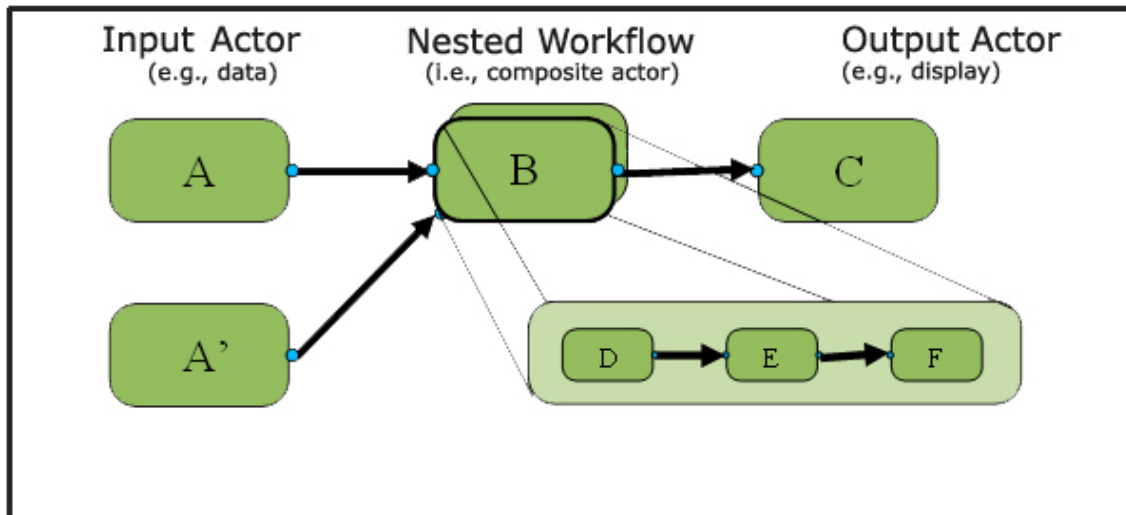

Figure 4: Representation of a nested workflow.

Kepler provides a large set of actors for creating and editing scientific workflows. Actors can be added to Kepler for an individual's exclusive use and/or can be made available to others.

4.2. Ports

Each actor in a workflow can contain one or more ports used to consume or produce data and communicate with other actors in the workflow. Actors are connected in a workflow via their ports. The link that represents data flow between one actor port and another actor port is called a channel. Ports are categorized into three types:

- input port – for data consumed by the actor;
- output port – for data produced by the actor; and
- input/output port – for data both consumed and produced by the actor.

Each port is configured to be either a “singular” or “multiple” port. A single input port can be connected to only a single channel, whereas a multiple input port can be connected to multiple channels. Single ports are designated with a dark triangle; multiple ports use a hollow triangle.

Workflows can also use external ports and port parameters. See the Ptolemy documentation for more information.

4.3. Relations

Relations allow users to “branch” a data flow. Branched data can be sent to multiple places in the workflow. For example, a scientist might wish to direct the output of an operational actor to another operational actor for further processing, and to a display actor to display the data at that specific reference point. By placing a Relation in the output data channel, the user can direct the information to both places simultaneously.

4.4. Parameters

Parameters are configurable values that can be attached to a workflow or to individual directors or actors. For example, the *Integrator* actor has a parameter called `InitialState` that should be set to the initial value of the function being integrated. The parameters of simulation model actors can be configured to control certain aspects of the simulation, such as initial values. Director parameters control the number of workflow iterations and the relevant criteria for each iteration.

The next sections provide an overview of the interface and step-by-step examples of how to open, edit, and run different scientific workflows.

5. Kepler Interface

Scientific workflows are edited and built in Kepler’s easily navigated, drag-and-drop interface. The major sections of the Kepler application window (*Figure 5*) consist of the following:

- Menu bar – provides access to all Kepler functions.
- Toolbar – provides access to the most commonly used Kepler functions.
- Components and Data Access area – consists of a Components tab and Data tab. Both tabs contain a search function and display the library of available components and/or search results.
- Workflow canvas – provides space for displaying and creating workflows.

- Navigation area – displays the full workflow. Click a section of the workflow displayed in the Navigation area to select and display that section on the Workflow canvas.

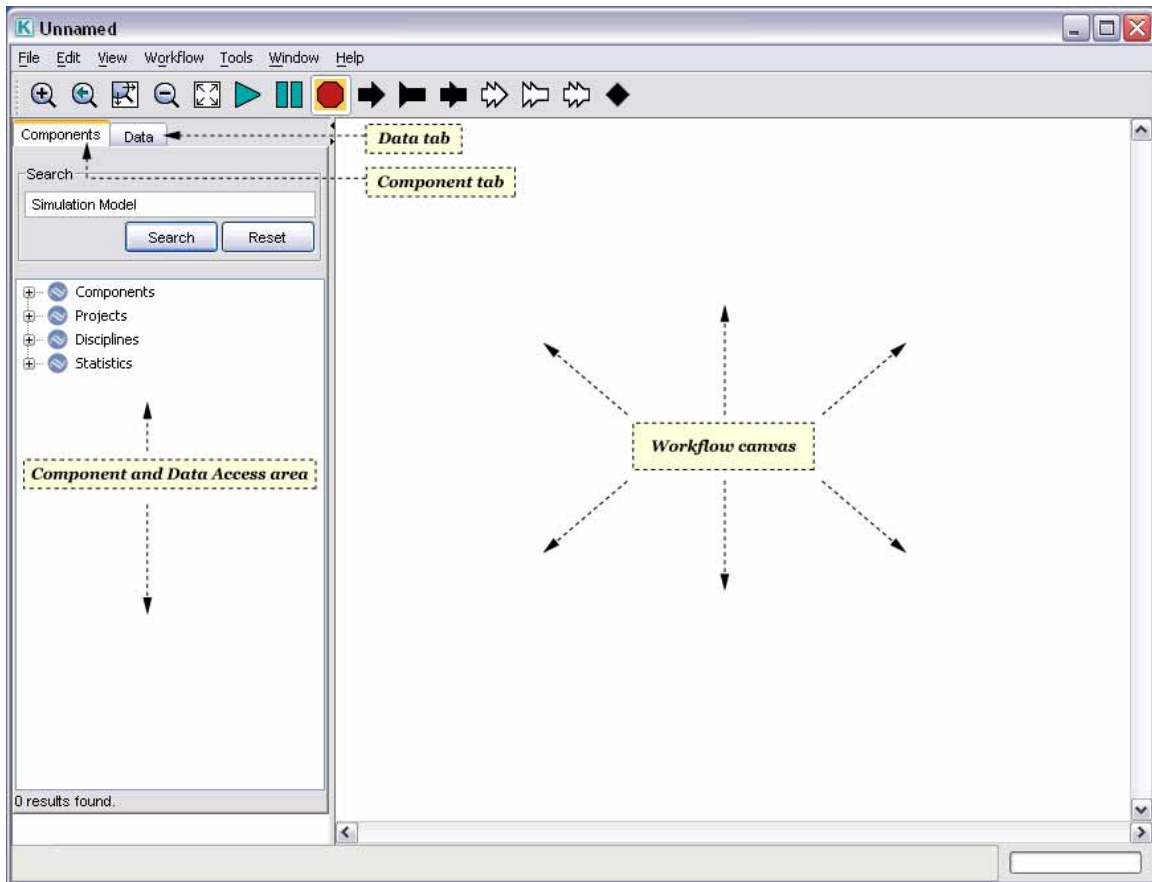

Figure 5: Empty Kepler window with major sections annotated.

5.1. The Toolbar

The Kepler toolbar is designed to contain the most commonly used Kepler functions (*Figure 6*).

The main sections of the toolbar include:

- Viewing – zoom in, reset, fit, and zoom out of the workflow on the Workflow canvas
- Run – run, pause, and stop the workflow without opening the Run window
- Ports – add single (black) or multi (white) input and output ports to workflows; add Relations to workflows

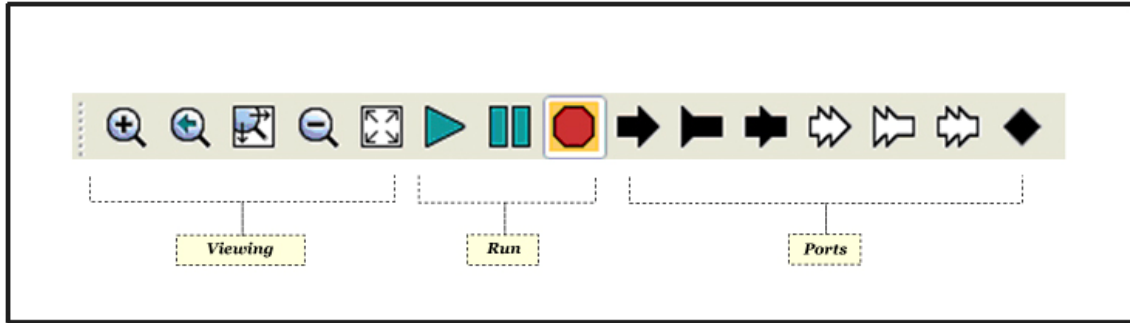

Figure 6: Annotated Kepler Toolbar

5.2. Components and Data Access Area

The Components and Data Access area contains a library of workflow components (e.g., directors and actors, under the Components tab) and a search mechanism for locating and using data sets (under the Data tab). When the application is first opened, the Components tab is displayed.

Components in Kepler are arranged in four high-level categorizations: Components, Projects, Disciplines, and Statistics (*Table 1*). Any given component can be classified in multiple categories, appearing in multiple places in the component tree. Use any instance of the actor—only its categorization is different.

Browse for components by clicking through the trees, or use the search function at the top of the Components tab to find a specific component. For more information about searching for components, see section 6.4.2.

Category	Description
Components	Contains a standard library of all components, arranged by function.
Projects	Contains a library of project-specific components (e.g., SEEK or CIPRes)
Disciplines	Contains a library of components arranged by discipline (e.g., Chemistry or Ecology)
Statistics	Contains a library of components for use with statistical analysis.





Table 1: Component Categories in Kepler









Click the Data tab to reveal the Data Access area. From here, you can easily search the EarthGrid for remotely hosted data sets. For more information about searching for data, see section 6.4.1.

5.3. Director and Actor Icons

In Kepler, icons provide a visual representation of each component's function. Directors are represented by a single icon; actors are divided into functional categories, or families, with each category assigned a visually related icon (*Table 2*).

Some actor families have a persistent family symbol, other families do not. The majority of the actor icons use a teal rectangle, though some icons, such as the Data/File Access icons use other colors and/or shapes. In the table below, persistent symbols are noted. For families that do not have a persistent symbol, an example of one of the icons from that family is displayed. A table that includes *all* icons for each family can be found in Chapter 5 of the Kepler User Manual.

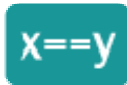
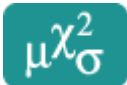
Icon	Family Name	Description
	Director	Stand-alone component that directs the other components (the actors) in their execution
	Array	Array actors are indicated with a curly brace. Actors belonging to this family are used for general array processing (e.g., array sorting).
	Composite	Composite actors are represented by multiple teal rectangles because they represent multiple actors. Composite actors are collections of actors bundled together to perform more complex operations (i.e., subworkflows) within an encapsulating workflow.
	Control	Control actors do not have a persistent family symbol. These actors are used to control workflows (e.g., stop, pause, or repeat).
	Data/File Access	Data/File Access actors do not have a persistent family symbol. Actors belonging to this family read, write, and query data. The icon displayed here is a data write icon.

Icon	Family Name	Description
	Data Processing	Data Processing actors assemble, disassemble, and update data.
	Display	Display actors are indicated by vertical bars. Actors belonging to this family output the workflow in text or graphical format
	File Management	File Management actors do not have a persistent family symbol. Actors belonging to this family locate or unzip files, for example. The icon displayed here is a directory listing icon.
	GAMESS	GAMESS actors are used for computational chemistry workflows.
	General	Actors that don't fit into one of the other families fall into the General family. General actors include email, file operation, and transformation actors, for example. The icon displayed here is a filter icon.
	GIS/Spatial	GIS/Spatial actors are used to process geospatial information
	Image Processing	Image Processing actors are used to manipulate graphics files.
	Logic	Logic actors have no persistent family symbol. Actors in this family include Boolean switches and logic functions. The icon displayed here is an equals icon.
	Math	Math actors have no persistent family symbol. Actors in this family include add, subtract, integral, and statistical functions. The icon displayed here is used to represent statistical functions (e.g., the <i>Quantizer</i> actor).
	Model	Model actors use a solid arrow. Model actors include statistical, mathematical, rule-based, and probability models. Note that icons will include additional symbols further identifying the actor function.







Icon	Family Name	Description
	Molecular Processing	Molecular Processing actors are indicated by a molecule icon in the upper left corner.
	Other/External Program	Other/External Program actors are indicated by a purple rectangle. External Program actors include R, SAS, and MATLAB actors. The icon displayed here is an R icon.
	String	String actors are indicated with the text string().String actors are used to manipulate strings in a variety of ways
	Utility	Utility actors are indicated with a wrench. Utility actors help manage and tune a particular aspect of an application.
	Web Services	Web Services actors are indicated by a wireframe globe. Actors in this family execute remote services.
	Units	Unit components define a system of units.

Table 2: The major Kepler icons

5.4. The Workflow Canvas

Scientific workflows are opened, created, and modified on the Workflow canvas. Components are easily dragged and dropped from the Component and Data Access area to the desired canvas location. Each component is represented by an icon (see Section 5.3 for examples), which makes identifying the components simple. Connections between the components (i.e., channels) are also represented visually so that the flow of data and processing is clear.

Each time you open an existing workflow or create a new workflow, a new application window opens. Multiple windows allow you to work on several workflows simultaneously and compare, copy, and paste components between Workflow canvases.

6. Basic Operations in Kepler

This section covers the basic operations in Kepler: opening and running an existing workflow, and some techniques for editing, designing, and creating your own workflows.

6.1. Opening an Existing Scientific Workflow

To open any existing workflow:

1. From the Menu bar, select File, then Open File. A standard file dialog box will appear.
2. If the file dialog box does not open to the “kepler” directory (the place where the Kepler program is installed), then navigate to that directory. Workflows discussed in this guide are stored in Kepler's "/demos/getting-started" directory.

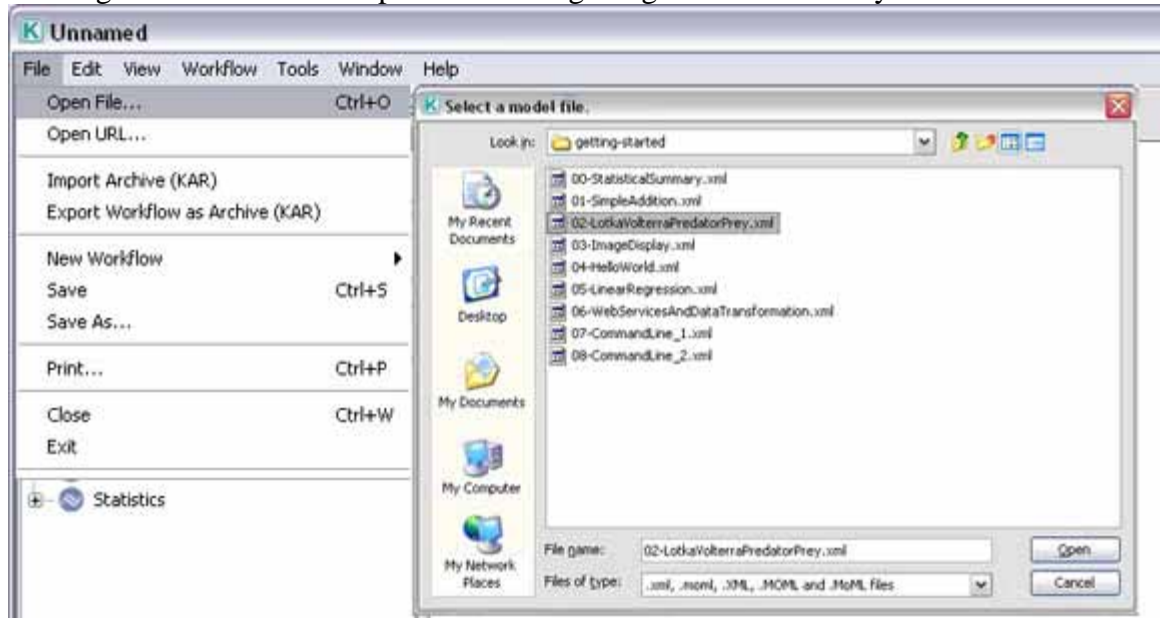

3. Double-click a workflow file to open it. The workflow will appear in the Workflow canvas of the application window.

6.1.1. Example 1: Opening the Lotka-Volterra Workflow

In this example we will open a specific workflow: the classic predator pray model, the Lotka-Volterra workflow. To open this workflow:

1. From the Menu bar, select File, then Open File. A standard file dialog box will appear.
2. Navigate to Kepler's "/demos/getting-started" directory and locate the file named “02-LotkaVolterraPredatorPrey.xml” (*Figure 7*).

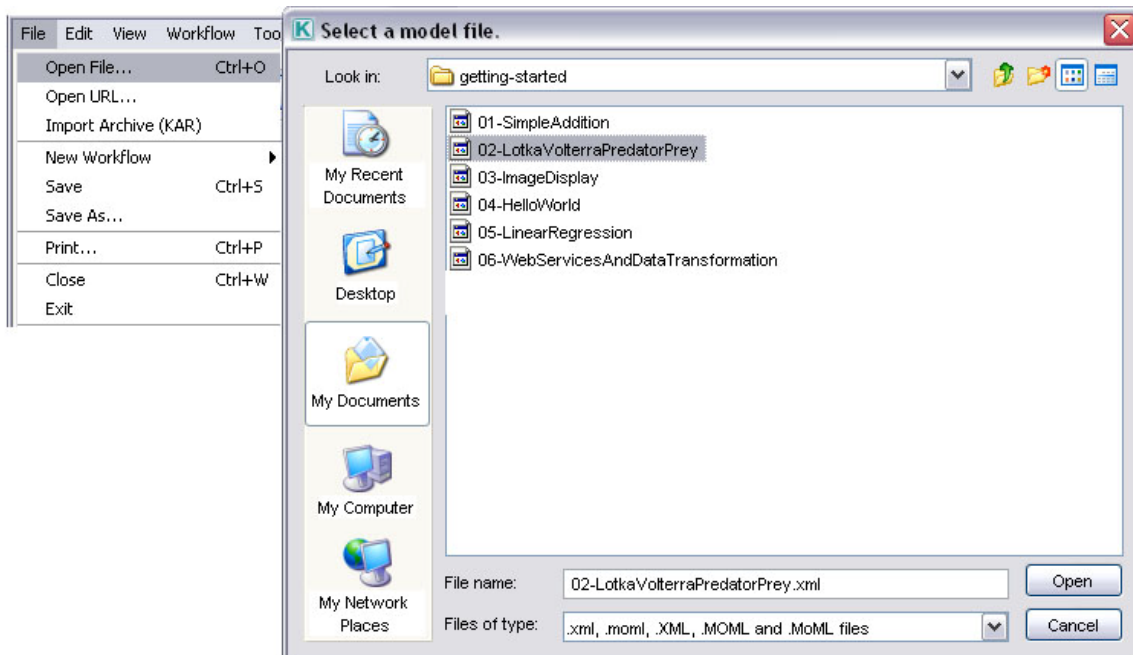

Figure 7: Navigating to the Lotka-Volterra workflow. The workflow is in Kepler's “/demos/getting-started” directory.

3. Double-click the “02-LotkaVolterraPredatorPrey.xml” file. The Lotka-Volterra workflow appears in the Workflow canvas of the application window (*Figure 8*).

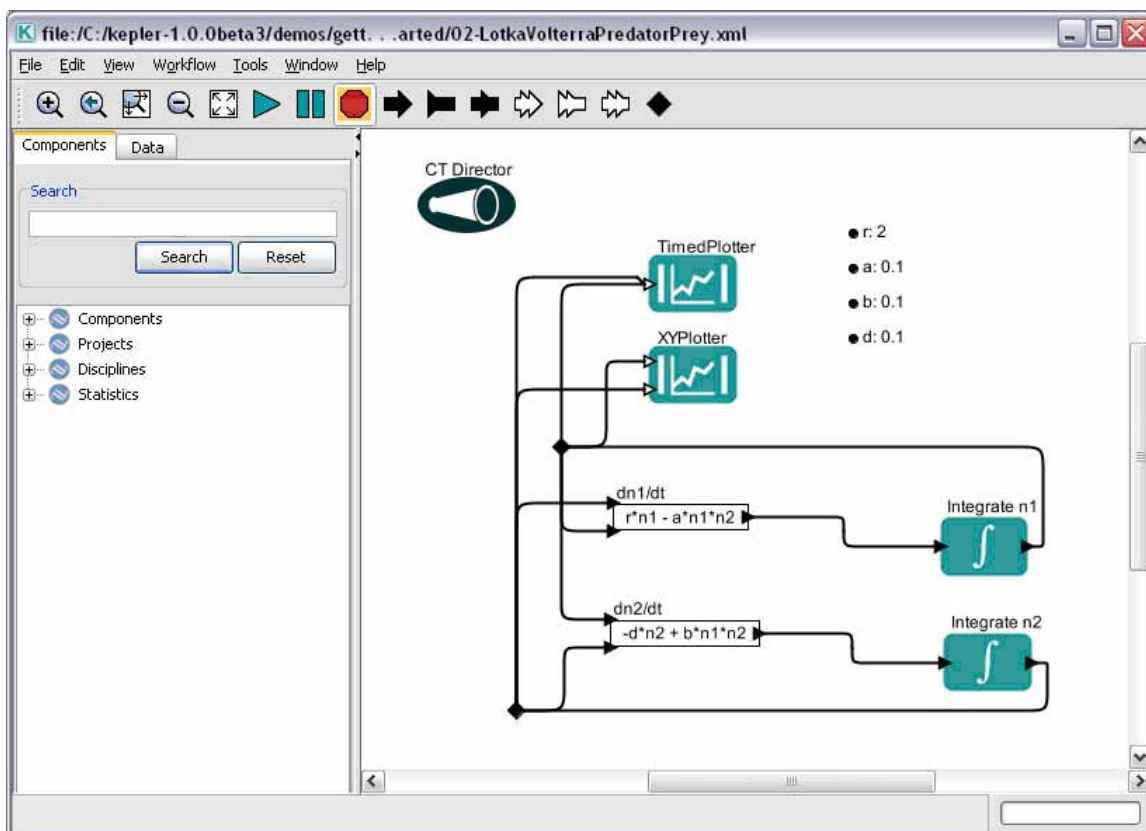



Figure 8: The Lotka-Volterra workflow in the Kepler interface.

6.2. Running an Existing Scientific Workflow

To run any existing scientific workflow:

1. Open the desired workflow.
2. From the Toolbar, select the Run button. ()
3. The workflow will execute and produce the specified output.

OR

1. Open the desired workflow.
2. From the Menu bar, select Workflow, then Runtime Window. A Run window will appear (*Figure 9*). If the workflow has parameters, they will appear here.
3. Adjust the parameters as needed, and then click the Go button.
4. The workflow will execute and produce the specified output. During workflow execution, you may select the Pause, Resume, or Stop buttons.

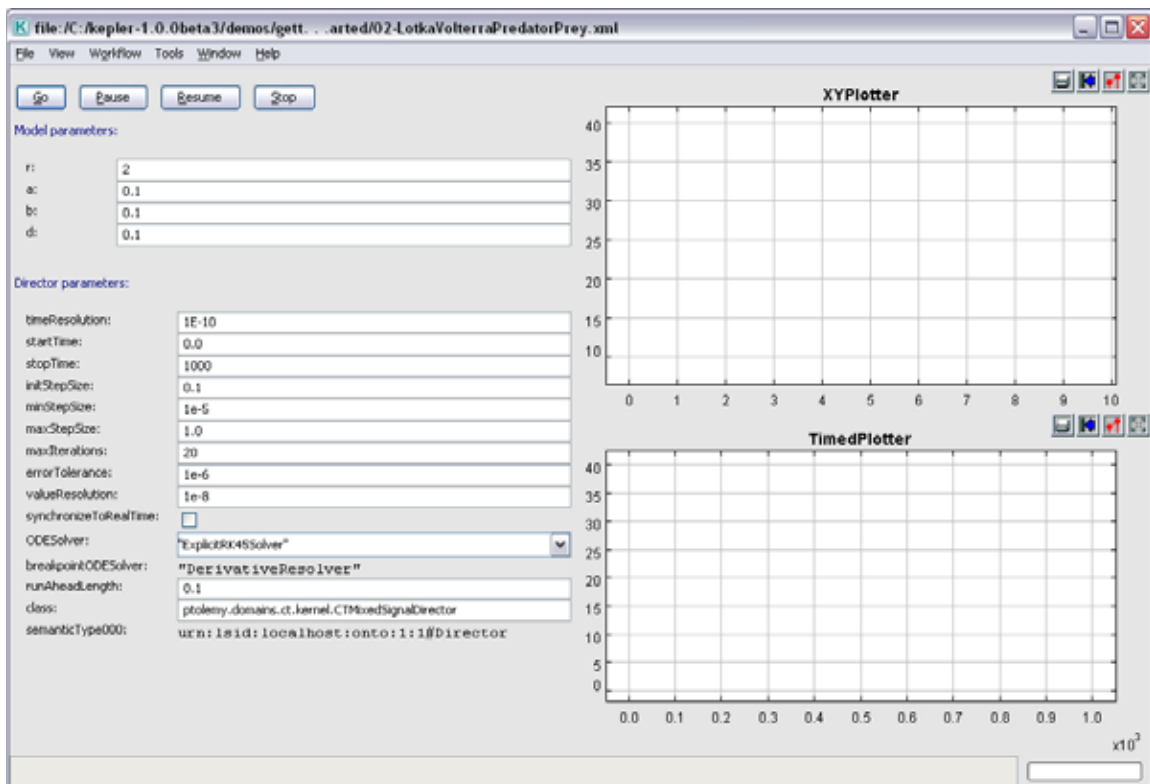

Figure 9: The Runtime window, displaying the Lotka-Volterra workflow. Click the Go button to run the workflow. Director and model parameters can be edited in the Runtime window. Output is displayed in the window as well.

6.2.1. Example 2: Running the Lotka-Volterra Workflow with Default Parameters

The Lotka-Volterra model uses the continuous time domain (i.e., a *CT Director*) in Kepler to solve two coupled differential equations: one that models the predator population; and one that models the prey population. The results are plotted as they are calculated, showing both populations change and a phase diagram. For more information about the model, see Section 6.2.2.

To run the Lotka-Volterra workflow:

1. Open the workflow file named “02-LotkaVolterraPredatorPrey” from Kepler’s “/demos/getting-started/” directory.
2. From the Menu bar, select Run.
3. The Lotka-Volterra workflow will execute with the default parameters and produce two graphs. The graph labeled TimedPlotter depicts the interaction of predator and prey over time (i.e., the cyclical changes of the predator and prey populations over time predicted by the model). The graph labeled XYPlotter depicts a phase portrait of the population cycle (i.e., the predator population against the prey population). Together these graphs show how the predator and prey populations are linked: as prey increases, the number of predators increase. (*Figure 10*)

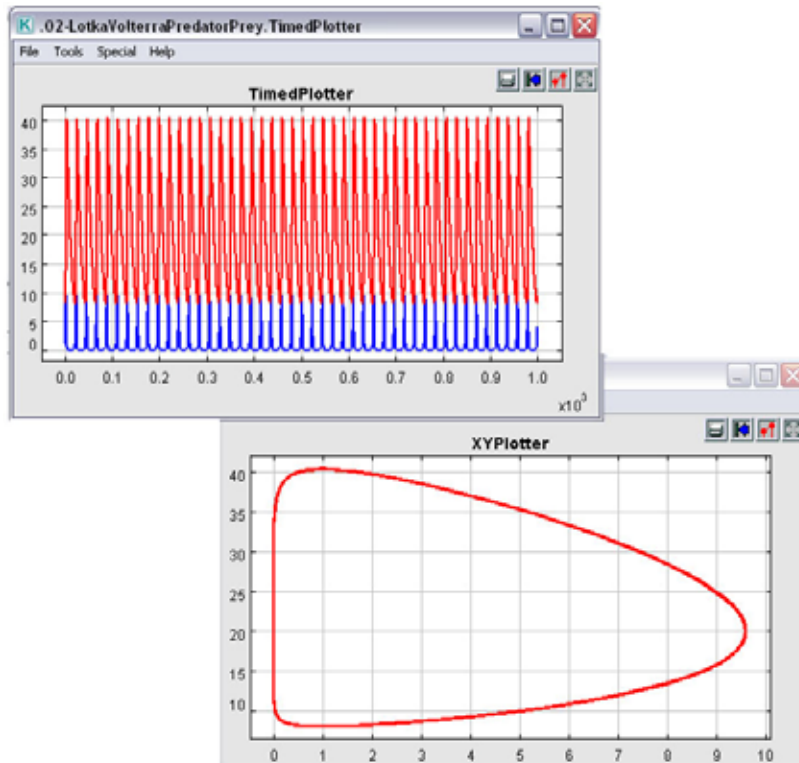

Figure 10: Graphs output by the Lotka-Volterra workflow

6.2.2. Example 3: Running the Lotka-Volterra Workflow with Adjusted Parameters

To better illustrate the effect of parameters on a workflow, we must first provide some background about the Lotka-Volterra workflow (*Figure 11*).

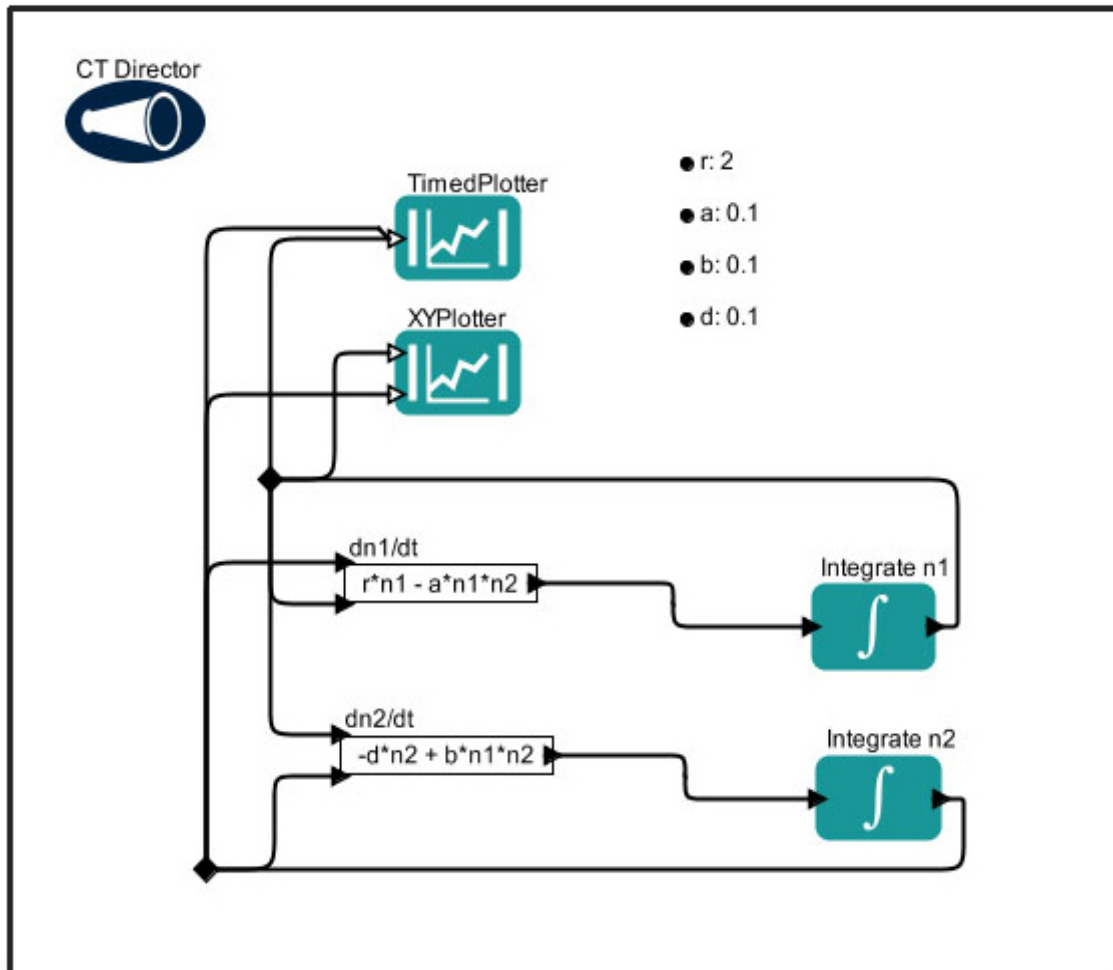

Figure 11: Graphic of Lotka-Volterra workflow

The Lotka-Volterra model was developed independently by Lotka (1925)² and Volterra (1926)³ and is made up of two differential equations. One describes how the prey population changes ($\frac{dn1}{dt} = r*n1 - a*n1*n2$), and the second equation describes how the predator population changes ($\frac{dn2}{dt} = -d*n2 + b*n1*n2$).

The Lotka-Volterra model is based on certain assumptions:

- the prey has unlimited resources;

² Lotka, Alfred J (1925). Elements of physical biology. Baltimore: Williams & Williams Co.

³ Volterra, Vito (1926) Fluctuations in the abundance of a species considered mathematically. Nature 118. 558-560.

- the prey's only threat is the predator;
- the predator is a specialist (i.e., the predator's only food supply is the prey); and
- the predator's growth depends on the prey it catches

The Lotka-Volterra model as represented in Kepler as a scientific workflow contains:

- six actors - two plotters, two equations, and two integral functions;
- one director; and
- four workflow parameters (*Table 3*).

NOTE: The director of the Lotka_Volterra model has several configurable parameters as do the two plotter actors.

The critical assumptions above provide the basis for the workflow parameters. The workflow parameters and their defaults are as follows:

Parameter	Default Value	Description
r	2	the intrinsic rate of growth of prey in the absence of predation
a	0.1	capture efficiency of a predator or death rate of prey due to predation
b	0.1	proportion of consumed prey biomass converted into predator biomass (i.e., efficiency of turning prey into new predators)
d	0.1	death rate of the predator

Table 3: Description of the default parameters for the Lotka-Volterra workflow

In the differential equations used in the workflow, ($dn_1/dt = r*n_1 - a*n_1*n_2$) and ($dn_2/dt = -d*n_2 + b*n_1*n_2$), the variable n_1 represents prey density, and the variable n_2 represents predator density.

When changing parameters in a workflow, the assumptions of the model must be kept in mind. For example, if creating a Lotka-Volterra model with rabbits as prey and foxes as predators, the following assumptions can be made with regard to how the rabbit population changes in response to fox population behavior:

- the rabbit population grows exponentially unless it is controlled by a predator;
- rabbit mortality is determined by fox predation;
- foxes eat rabbits at a rate proportional to the number of encounters;
- the fox population growth rate is determined by the number of rabbits they eat and their efficiency of converting the eaten rabbits into new baby foxes; and
- fox mortality is determined by natural processes.

If you think of each run of the model in terms of the rates at which these processes would occur, then you can think of changing the parameters in terms of percent of change over time.

To run the Lotka-Volterra workflow with adjusted parameters:

1. Open the workflow file named “02-LotkaVolterraPredatorPrey” from Kepler's “/demos/getting-started” directory
2. From the Menu bar, select Workflow, then Runtime Window. The Runtime window will appear. Notice there are two sets of parameters – one for the workflow and one for the director. In this example, you will make adjustments to both sets of parameters.
3. Adjust the workflow parameters as suggested in Table 4.

Parameter	Value	Description
r	0.04	the intrinsic rate of growth of prey in the absence of predation
a	0.0005	capture efficiency of a predator or death rate of prey due to predation
b	0.1	proportion of consumed prey biomass converted into predator biomass (i.e., efficiency of turning prey into new predators)
d	0.2	death rate of the predator

Table 4: Description of the suggested parameters for the Lotka-Volterra workflow taken from <http://www.stolaf.edu/people/mckelvey/envision.dir/lotka-volt.html>

4. Adjust the value of the stopTime director parameter to 300.
5. In the Runtime window, click the Go button.

The Lotka-Volterra workflow will execute with the adjusted parameters and produce two graphs: 1) the TimedPlotter graph and 2) the XYPlotter graph. Note that with the changes in the parameters, the relationship between the predator and prey populations are still linked but the relationship has changed.

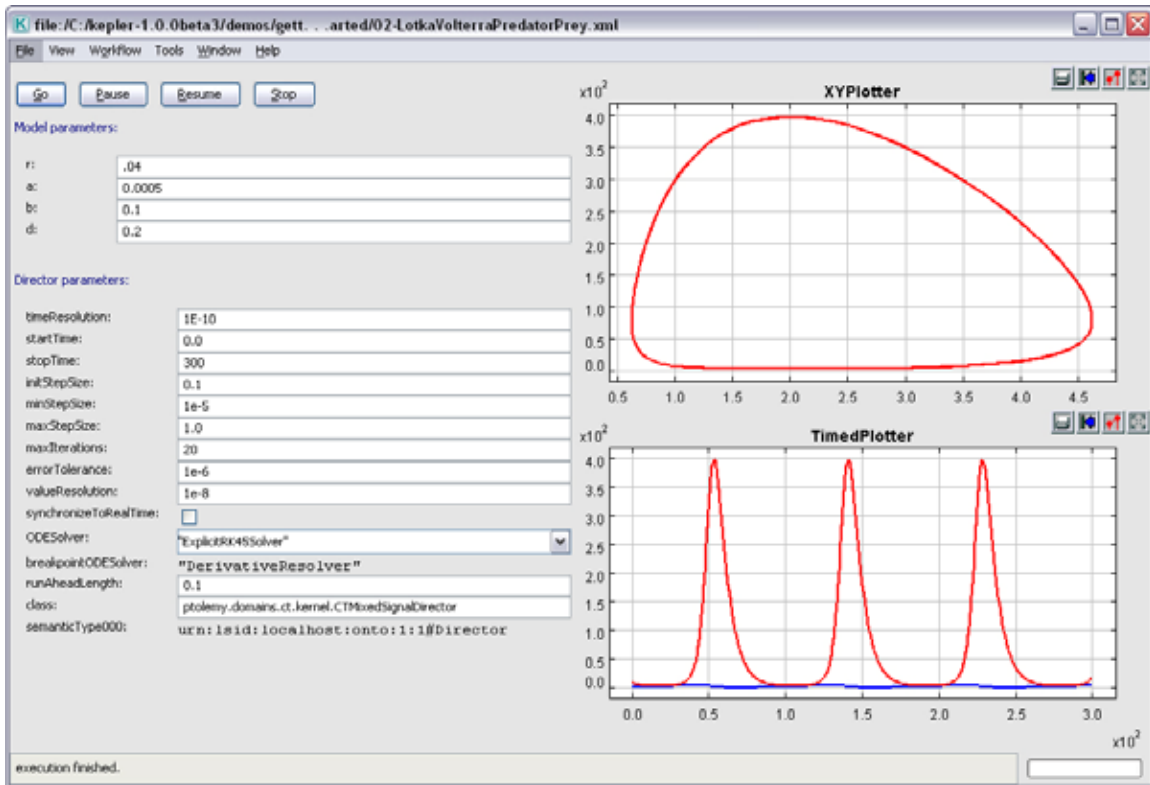

Figure 12: Graphs output by the Lotka-Volterra model with adjusted parameters

6.3. Editing an Existing Scientific Workflow

There are two ways to edit an existing scientific workflow:

- substitute a different data set for the current data set; or
- substitute one or more analytical processes in the workflow with other analytical processes (e.g., substitute a neural network model actor for a probabilistic model actor).

Before substituting data or processes, you must understand the required inputs and outputs of the actors involved.

NOTE: To see a high-level description of an actor, right-click that actor to display a menu; select Documentation, then Display (*Figure 13*). A dialog box containing a description of the main function of the actor and its required inputs and output appears. When finished with this dialog, close the window.

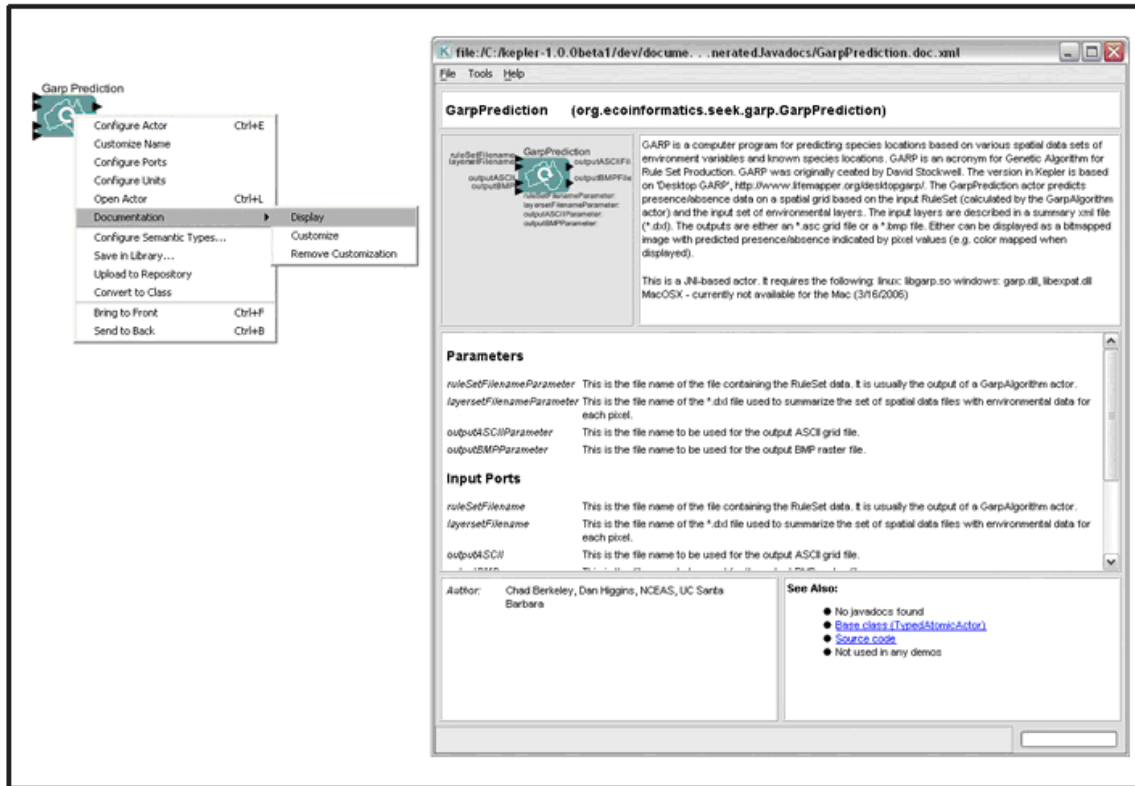

Figure 13: Displaying actor documentation

To edit an existing scientific workflow:

1. Open the desired workflow.
2. Identify which workflow component is the target for substitution.
3. Select the target component (data actor or processing actor) by clicking it. The selected component will be highlighted in a thick yellow border.
4. Press the Delete key on your keyboard. The highlighted component will disappear from the Workflow canvas.
5. From the Components and Data Access area, drag either an appropriate data or processing actor to the Workflow canvas.
6. Connect the appropriate input and output ports.
7. Run the workflow.
8. From the Menu bar, select File, then Save (to save over the existing workflow) or Save As (to save as a new workflow). If using the Save As option, enter a new workflow name when prompted.

6.3.1. Example 4: Editing/Substituting Analytical Processes in the Image J Workflow

In this example, we will show how two different actors can perform the same function in a workflow. We will work with the Image Display workflow (03-ImageDisplay.xml) found in Kepler's “/demos/getting-started/” directory, and we will substitute the *Browser*

Display actor for the *ImageJ* actor. Both actors will display a bitmapped image representing the species distribution of the species *Mephitis* throughout North and South America. (This image was created by GARP, a genetic algorithm that creates an ecological niche model for a species that represents the environmental conditions where that species would be able to maintain populations. GARP was originally developed by David Stockwell, at the [San Diego Supercomputer Center](http://www.lifemapper.org/desktopgarp/). For more information on GARP, see <http://www.lifemapper.org/desktopgarp/>.)

To edit the Image Display workflow:

1. Open the 03-Image-Display.xml workflow from Kepler's “/demos/getting-started/” directory.
2. Select the target component, the *ImageJ* actor in this case. The *ImageJ* actor will be highlighted in a thick yellow border, indicating that it is selected (*Figure 14*).

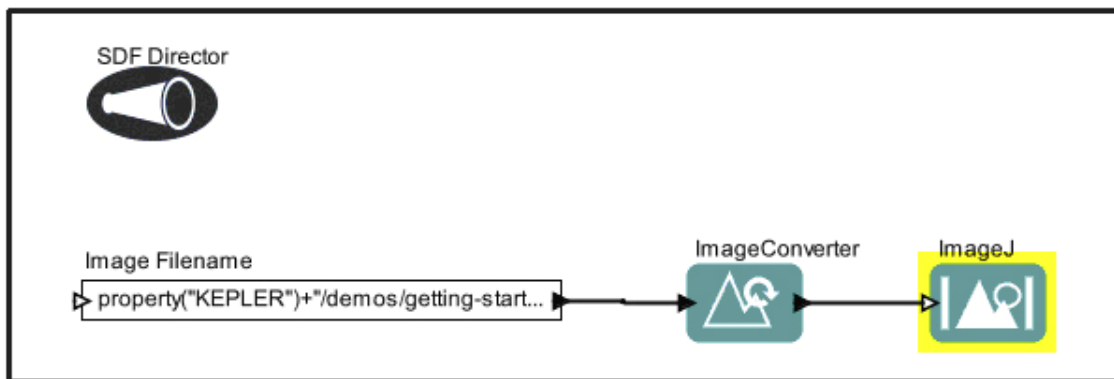

Figure 14: Image Display workflow showing *ImageJ* actor highlighted

3. Press the Delete key on your keyboard. The *ImageJ* actor will disappear from the Workflow canvas.
4. From the Components and Data Access area, drag the *Browser Display* actor to the Workflow canvas. You can find the *Browser Display* actor in the Components tab under “Components > Data Output > Workflow Output > Textual Output.”
5. Connect the output port of the *ImageConverter* actor to the input port of the *Browser Display* actor. To connect the ports, left-click and hold on the output port (black triangle) on the right side of the *Image Converter* actor, drag the pointer to the upper input port on the left side of the *Browser Display* actor, and then release the mouse. If the connection is made, you will see a thick black line. If the connection is not completely made, the line will be thin.
6. Run the workflow.
7. From the Menu bar, select File, then Save (to save over the existing workflow) or Save As (to save as a new workflow). If using the Save As option, enter a new workflow name when prompted.

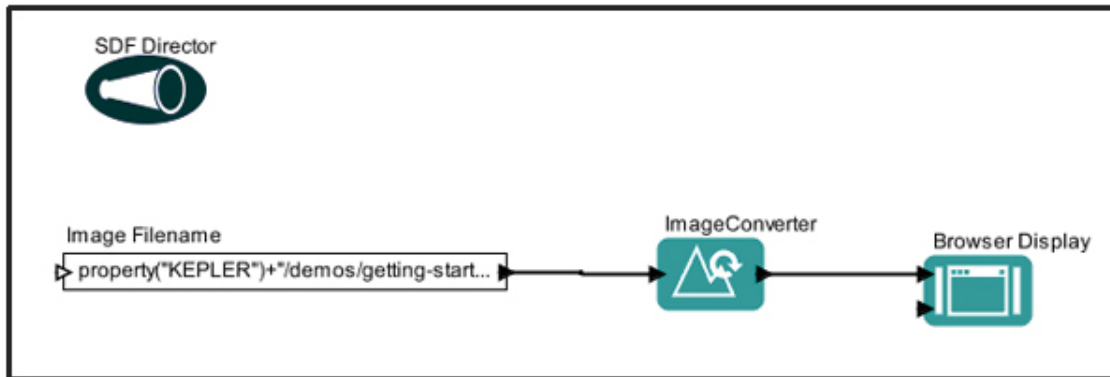

Figure 15: The Image Display workflow with the *Browser Display* actor substituted for the *ImageJ* actor.

NOTE: Sometimes the easiest way to connect actors is to go from the output port of the source to the input port of the destination.

6.4. Searching in Kepler

Kepler provides a searching mechanism to locate data (on the EarthGrid) and analytical processing components (on the local system or both the local system and a remote component repository). The examples given in this section describe searching for data and components in Kepler.

6.4.1. Searching for Available Data

Via its search capabilities, Kepler provides access to data from the EarthGrid. EarthGrid resources are stored in the KNB Metacat <http://knb.ecoinformatics.org> and the KU Digir <http://www.specifysoftware.org/Informatics/informaticsdigir/> databases. To search for data on the EarthGrid through Kepler:

1. In the Components and Data Access area, select the Data tab (*Figure 16*).
2. Type in the desired search string (e.g., Datos Meteorologicos). Make sure that the search string is spelled correctly. (You can also enter just part of the entire string – e.g. ‘Datos’)
3. Click the Search button. The search may take several moments. You may be prompted for log in credentials. If so, enter your user and password information, or click "Login Anonymously." When the search is complete, a list of search results (i.e., Data actors) will be displayed in the Components and Data Access area.
4. To use one or more data actors in a workflow, simply drag the desired actors to the Workflow canvas.

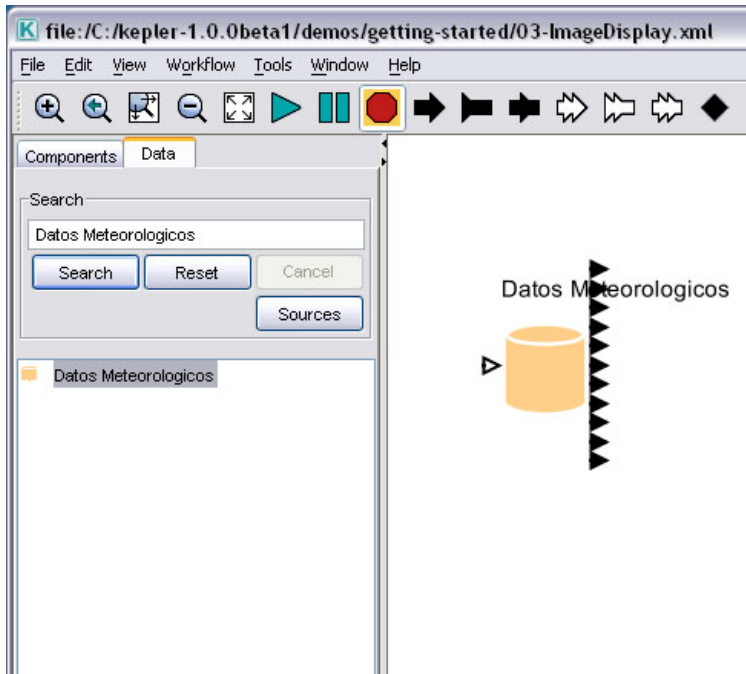

Figure 16: Searching for and locating Datos Meteorologicos

NOTE: To configure the data search, click the Sources button. Select the sources to be searched and the type of documents to be retrieved.

Information about a Data actor can be revealed in three ways: (1) on the Workflow canvas, roll over the Data actor's data output ports to reveal a tool tip containing the name and type of data output by each port; (2) right-click the Data actor and select Get Metadata to open a window containing more information about the data set; (3) right-click the data actor and select Preview from the drop-down menu to preview the data set (*Figure 17*).

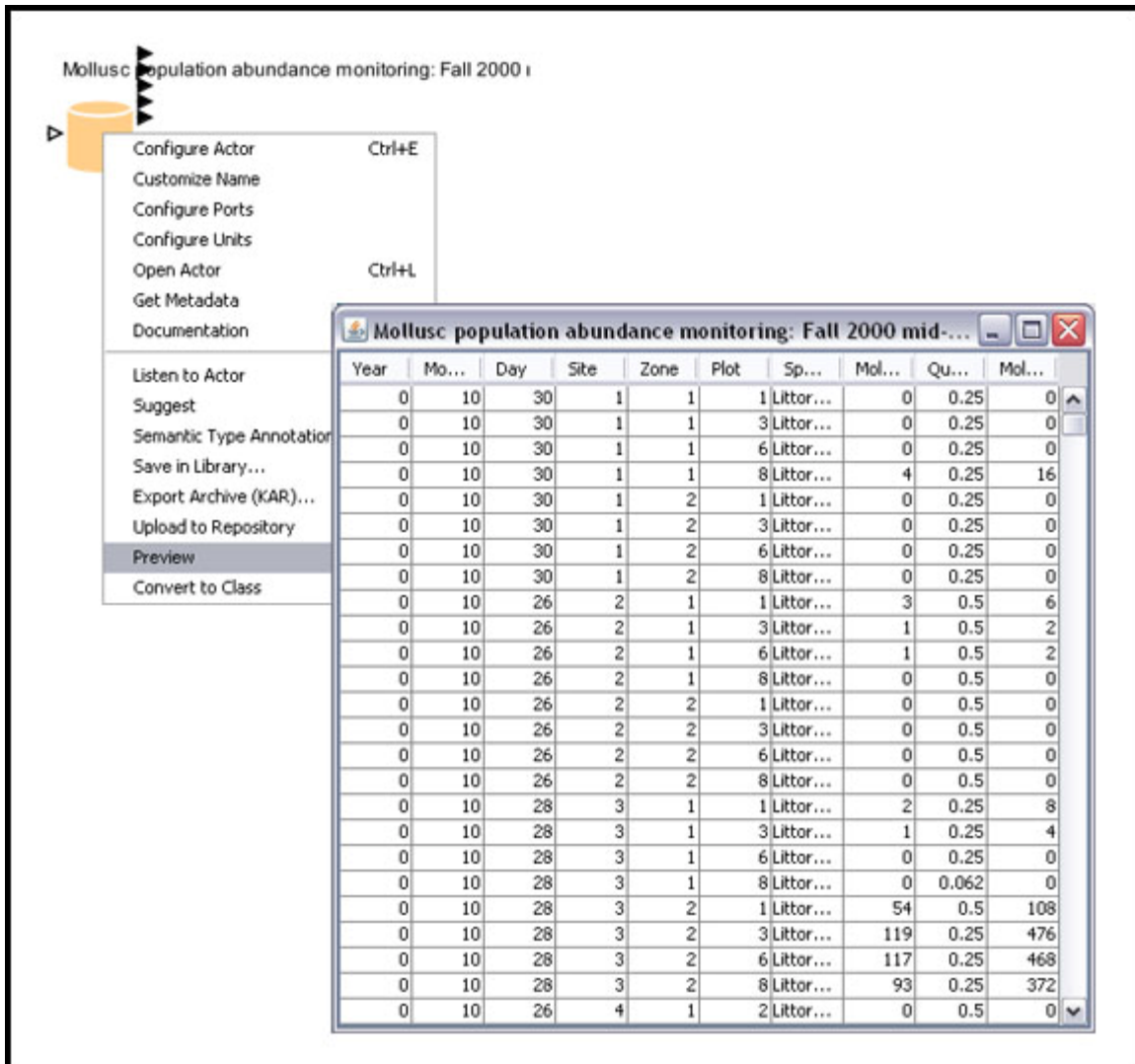

Figure 17: Previewing a data set.

6.4.2. Searching for Available Processing Components

Kepler comes standard with over 350 workflow components and the ability to modify and create your own. You can create an innumerable number of workflows with a variety of analytic functions. The default set of Kepler processing components is displayed under the Components tab in the Components and Data Access area. Components are organized by function (e.g., “Director” or “Filter Actor”). To search for components:

1. In the Components and Data Access area to the left of the Workflow canvas, select the Components tab.
2. Type in the desired search string (e.g., “File Fetcher”).
3. Click the Search button. When the search is complete, the search results are displayed in the Components and Data Access area. The search results replace the default list of components. You may notice multiple instances of the same

component (Because components are arranged by category, the same component may appear in multiple places in the search results.)

4. To use one or more processing components in a workflow, simply drag the desired components to the Workflow canvas.
5. To clear the search results and re-display the list of default components, click the Reset button.

NOTE: If you know which component you want to use and its location in the Component library, you can navigate to it directly, and then drag it to the Workflow canvas.

6.5. Creating a Basic Scientific Workflow

One of the strengths of Kepler is the ability to design, create, and save your own executable workflows. The general steps in creating a workflow are as follows:

1. Create a conceptual (paper or other medium) model of your scientific workflow.
2. Open the Kepler application.
3. Map the data and actor components available in Kepler to your conceptual model.
4. Select a director for your workflow and drag it to the Workflow canvas. For more information about choosing a director, please see Chapter 5 of the [Kepler User Manual](#).
5. Drag the desired workflow components to the Workflow canvas.
6. Connect the workflow components.
7. Save the workflow.

The examples in this section illustrate how to begin to create your own workflows. The first example is the classic “Hello World” workflow that demonstrates how easy it is to create a functioning workflow in Kepler. The second example is more practical and shows how to use your desktop data in a workflow.

6.5.1. Example 5: Creating a “Hello World” Workflow

To create the “Hello World” workflow, begin by thinking about the type of data used (e.g., text or string data); the type of output desired (e.g., textual or image display); and the type of director needed to execute this model (e.g., synchronous or parallel) The “Hello World” workflow requires a constant actor, a text display actor, and a SDF director (in a SDF director, the data will flow through the actors based on the order in the workflow, and the workflow will run continuously, by default).

1. Open Kepler. A blank Workflow canvas will open.
2. In the Components and Data Access area, select the Components tab, then navigate to the “/Components/Director/” directory.
3. Drag the *SDF Director* to the top of the Workflow canvas.
4. In the Components tab, search for “Constant” and select the *Constant* actor.

5. Drag the *Constant* actor onto the Workflow canvas and place it a little below the *SDF Director*.
6. Configure the *Constant* actor by right-clicking the actor and selecting Configure Actor from the menu. (Figure 18)

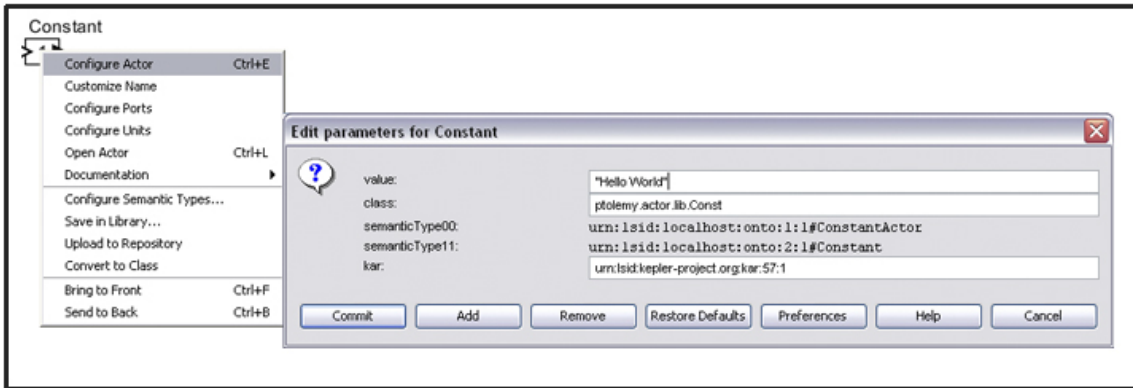

Figure 18: Configuring the *Constant* actor.

7. Type “Hello World” in the `value` field of the “Edit parameters for Constant” dialog window and click Commit to save your changes. “Hello World” is a string value. In Kepler, all string values must be surrounded by quotes.
8. In the Components and Data Access area, search for “Display” and select the *Display* actor found under “Textual Output.”
9. Drag the *Display* actor to the Workflow canvas.
10. Connect the output port of the *Constant* actor to the input port of the *Display* actor.
11. Run the model (Figure 19).

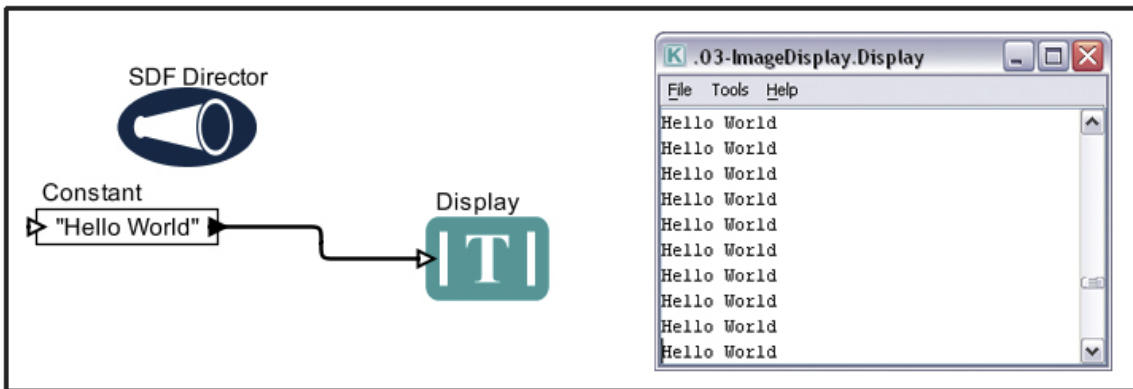

Figure 19: “Hello World” workflow and output.

NOTE: By default, the *SDF Director* will continuously run a workflow, creating a loop. To run “Hello World” a limited number of times, right-click on the *SDF Director* and select “Configure Director” from the menu. Type the desired number of iterations into the `iterations` field of the “Edit parameters for SDF Director” dialog window and click the Commit button to save your changes.

6.5.2. Example 6: Creating a Simple Workflow Using Local Data

In this example, we create a simple workflow using an actor that reads a local data file containing information about species abundance and then sends the data to a second actor for display.

Kepler can read data in many ways and from many formats. In this example, we will use an actor to review a data table. To determine which actor is appropriate, consider the format in which the data are saved. In this example, the data are saved in a text format. As such we will use the *File Reader* actor to read the data in a tabular format. This workflow requires two actors: a *File Reader* actor and a *Display* actor to output text. In addition, the example requires a *SDF Director*.

1. From the Menu bar, select File, then New Workflow, and then Blank. A new window will open with a blank Workflow canvas.
2. In the Components and Data Access area, select the Components tab, and then navigate to the “/Components/Director/” directory.
3. Drag the *SDF Director* to the top of the Workflow canvas.
4. In the Components tab, type “File Reader” in the Search box, then click the Search button.
5. Drag the *File Reader* actor to the Workflow canvas.
6. Right-click the *File Reader* actor and select Configure Actor from the menu. An “Edit parameters for File Reader” dialog window will open.
7. Click the Browse button to the right of the `fileOrURL` parameter and navigate to the following file: `mollusc_abundance.txt`. These data come installed in Kepler and are located in Kepler's `/demos/getting-started/` directory (Figure 20).

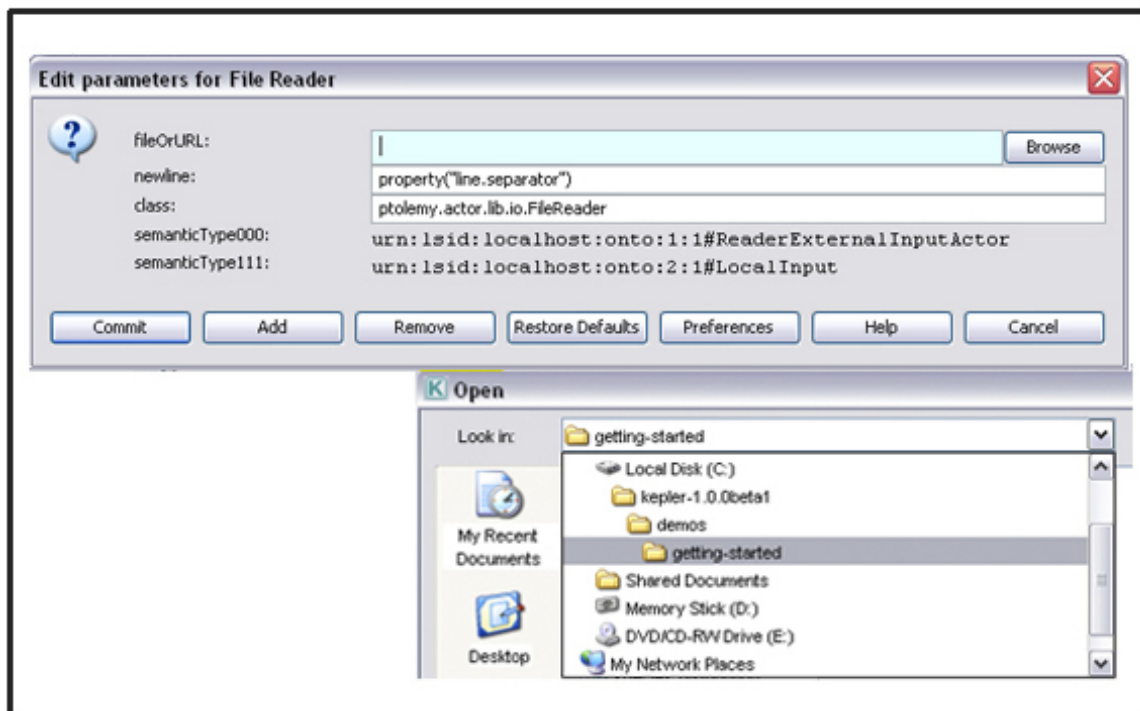

Figure 20: Configuring the *File Reader* actor to use data from your local machine.

8. Click the Commit button at the bottom of the “Edit Parameters for File Reader” dialog box. The actor is now configured to read the specified file.
9. In the Components tab, search for “Display”. Select the *Display* actor and drag it onto the Workflow canvas to the right of the *File Reader* actor.
10. Connect the output port of the *File Reader* actor to the input port of the *Display* actor.
11. From the Toolbar, select the Run button. A pop-up window will appear, displaying the contents of the data file in tabular format (*Figure 21*).
12. From the Menu bar, select File, then Save. When prompted, save the newly created workflow to the Kepler “demos/getting-started” directory with the name “readingdata.xml.”

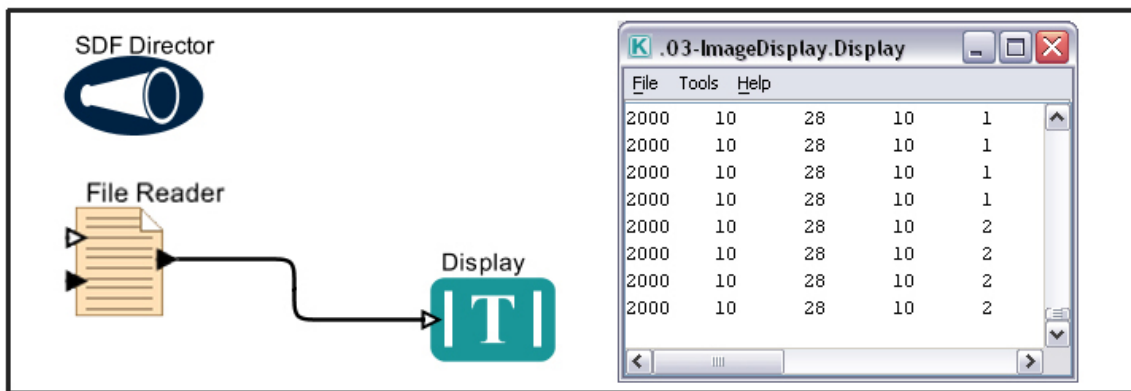

Figure 21: Using and displaying local data in a workflow.

NOTE: When creating a workflow, remember that the limitations of the data determine which processing components are appropriate.

7. Sample Scientific Workflows

This section examines a small set of sample scientific workflows that come standard with Kepler, and provides step-by-step instructions for creating these workflows.

7.1. Sample Workflow 1 – Simple Statistics

Name	Summary Statistics
File name	/kepler/demos/getting-started/00-StatisticalSummary.xml
Detailed Description	This workflow calculates the mean, standard deviation, and variance of a set of numerical values. The <i>Constant</i> actors contains the input data: an array of values {1,2,3,4,5,6,7,8,9,10}. These data are sent to the <i>SummaryStatistics</i> actor, which calculates the statistics and then outputs the results through its output ports. Results are displayed by three <i>TextDisplay</i> actors.

Assumptions	The <i>SummaryStatistics</i> actor is a special adaptation of the <i>RExpression</i> actor. <i>To run this workflow R, a language and environment for statistical computing, must be installed on the computer running the Kepler application.</i>
Director	<i>SDF Director</i>
Data	Data is generated in the <i>Constant</i> actor
Actors	<i>Constant, SummaryStatistics, Display</i>
Parameters	<i>SDF Director: iterations=1</i> <i>Constant: value= {1,2,3,4,5,6,7,8,9,10}</i>

The Summary Statistics workflow takes a list of numbers, calculates the mean, variance and standard deviation, and displays the results. This workflow highlights the ease and functionality of Kepler. *To run this workflow R, a language and environment for statistical computing, must be installed on the computer running the Kepler application. R is included with the full Kepler installation for Windows and Macintosh; R is not included with Kepler's Linux installer.* To create this workflow, open a new blank workflow from the File menu (File > New Workflow > Blank) and follow the steps below:

1. In the Components and Data Access area, select the Components tab.
2. Search for the *SDF Director* and drag and drop the director to the Workflow canvas.
3. Configure the *SDF Director* by right-clicking the director and selecting Configure Director. In the “Edit Parameters for SDF Director” window, set the *iterations* parameter to 1 and click Commit.
4. Search for the *Constant* actor and drag and drop that to the Workflow canvas. The *Constant* actor can be found under Components > Workflow > Workflow Input > Constant.
5. Configure the *Constant* actor by right-clicking the actor and selecting Configure Actor. In the “Edit Parameters for Constant” window, set the *value* field to {1,2,3,4,5,6,7,8,9,10} and click Commit. Note: The braces are needed. Curly braces designate an array in Kepler.
6. Search for the *SummaryStatistics* actor and drag and drop it to the Workflow canvas.
7. Locate the correct output ports of the *SummaryStatistics* actor by right-clicking the actor and selecting Configure Ports (*Figure 22*).
8. In the “Configure ports for SummaryStatistics” dialogue box, under the Show Name column, click the check box for *xmean*, *xstd*, and *xvar*. Click Commit to save your changes. The port names for the *xmean*, *xstd* and *xvar* outputs will now display on the Workflow canvas, making it easier to connect the proper ports.

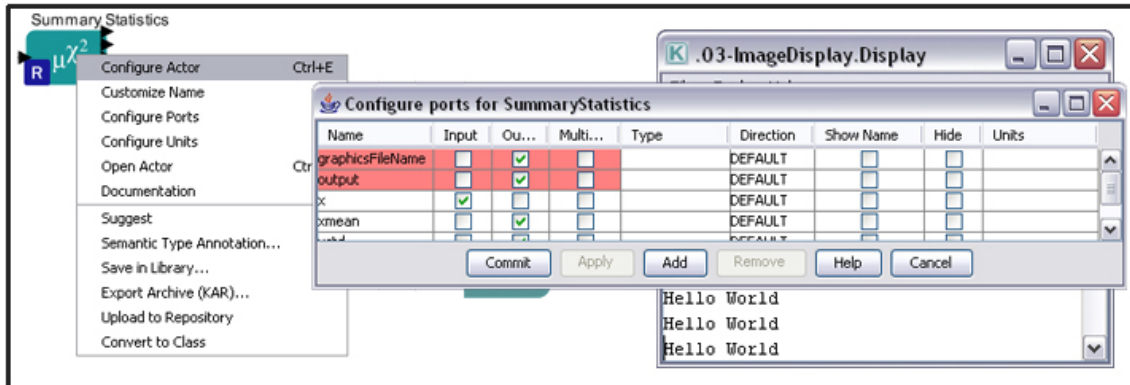

Figure 22: Displaying port names

9. Connect the output of the *Constant* actor to the input port of the *SummaryStatistics* actor.
10. Search for the text *Display* actor, and drag and drop that to the Workflow canvas three times. Note the second actor is named *Display2* and the third actor is named *Display3*.
11. Customize the name for the three text *Display* actors by right-clicking each and selecting *Customize Name*. In the “Rename Text Display” dialogue box for the *Display* actor, type “Mean” and click *Commit* to save your changes. Name the *Display2* actor “Variance” and the *Display3* actor “Standard Deviation”.
12. Connect the *xmean*, *xstd*, and *xvar* output ports of the *SummaryStatistics* actor to the input port on the corresponding *Mean*, *Standard Deviation*, and *Variance* actors.

You are now ready to run the workflow. The resulting workflow and output are displayed in *Figure 23*.

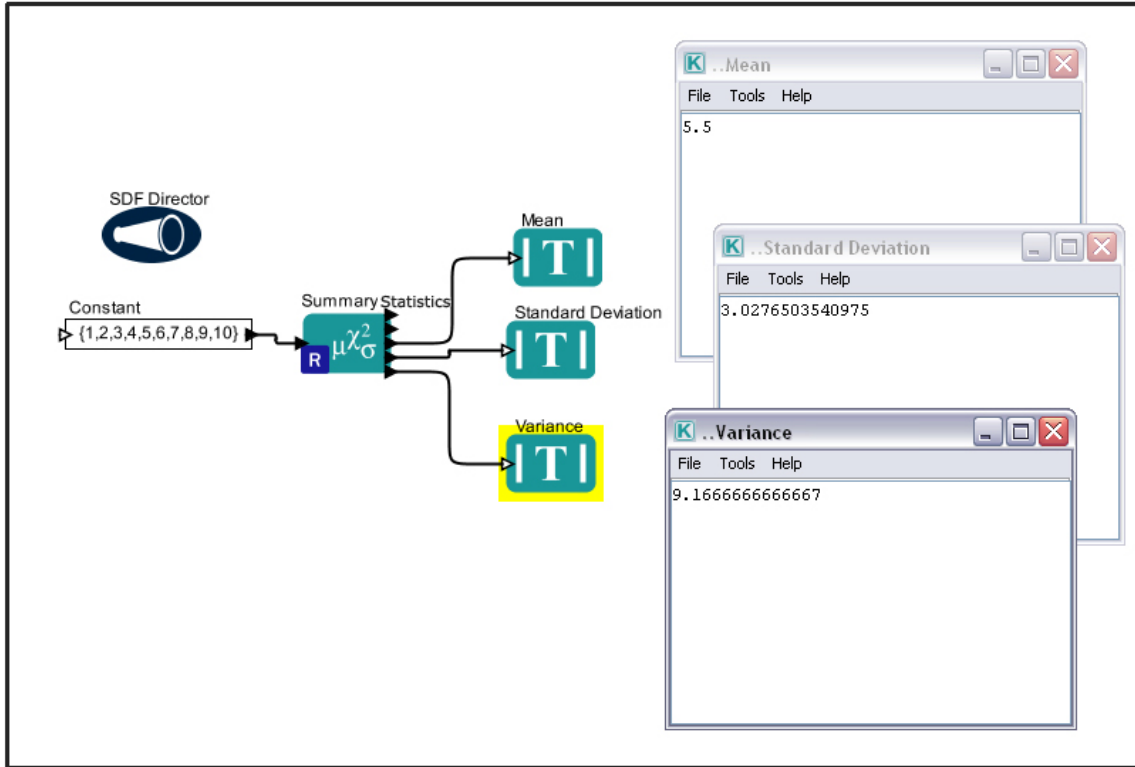

Figure 23: The Simple Statistics workflow and its output

The right-hand windows in *Figure 23* display the mean, variance, and standard deviation of the data set created by the array of values in the *Constant* actor. Change the input array of the *Constant* actor (for example, try {1,17,6,4,12}) to calculate a new set of corresponding statistics.

7.2. Sample Workflow 2 –Linear Regression

Name	Simple Linear Regression workflow using R
File name	/kepler/demos/getting-started/05-LinearRegression.xml
Detailed Description	This workflow performs a simple linear regression analysis using the <i>RExpression</i> actor. The workflow creates a scatter plot of the two variables from the Datos Meteorologicos data set and adds a regression line using the $Y = a + bX$ equation, where X is the explanatory variable and Y is the dependent variable. The slope of the line is b , and a is the intercept (the value of y when $x = 0$).
Assumptions	A linear regression assumes linearity, independence, homoscedasticity, and normality <i>R must be installed on the system running the workflow. R is included with the full Kepler installation for Windows and Macintosh.</i>
Director	<i>SDF Director</i>
Data	Datos Meteorologicos
Actors	<i>Datos Meteorologicos, RExpression, Display, ImageJ</i>

Parameters	<p><i>Datos Meteorologicos</i>: Data Output Format = As Column Vector</p> <p><i>SDF Director</i>: iterations = 1;</p> <p><i>RExpression</i>: R function or script =</p> <pre> res <- lm(BARO ~ T_AIR) res plot(T_AIR, BARO) abline(res); </pre> <p><i>RExpression</i>: input ports = 'T_AIR' and 'BARO.'</p>
------------	--------------------------------------------------------------------------------------------------------------------------------------------------------------------------------------------------------------------------------------------------------------------------------------------------------------------

The Simple Linear Regression workflow runs a search for data on the EarthGrid. These data are used to create a workflow conducting a linear regression. In this example, the input data comes from two output ports (the data columns on Barometric Pressure and Air Temperature) of the *Datos Meteorologicos* actor, a data set of meteorological data collected in 2001 from the La Hechicera station.

The Linear Regression workflow uses four actors (the *Datos Meteorologicos* actor, the *RExpression* actor, the *ImageJ* actor and the *Display* actor) and the *SDF Director*. The *RExpression* actor inserts R commands and scripts into the workflow. The *RExpression* actor makes integrating the powerful data manipulation and statistical functions of R into workflows easy. To implement the *RExpression* actor, R must be installed on the computer running the Kepler application.

NOTE: If you have problems creating this workflow, a stored version comes with Kepler at [kepler/demos/getting-started/05LinearRegression.xml](#).

To create the Simple Linear Regression workflow:

1. Select the Data tab in the Components and Data Access area.
2. Click the Sources button and limit the scope of the search by unchecking “KU Query Interface” and “KNB Metacat Authenticated Query Interface.” Because *Datos Meteorologicos* is stored on the KNB Metacat, the data source for the search can be limited to just those nodes on the EarthGrid.
3. Click Ok to confirm and save the search source changes.
4. Type *Datos Meteorologicos* in the search box and click Search. Results may take 20 seconds to return.
5. From the search results, click the *Datos Meteorologicos* icon. Drag and drop the *Datos Meteorologicos* actor to the Workflow canvas.

NOTE: To find more information about the data set, right-click *Datos Meteorologicos* on the Workflow canvas and select Get Metadata (*Figure 24*). Depending upon the amount of information entered by the provider, much valuable metadata can be obtained. The type of value and measurement type of each attribute help you decide which statistical models are appropriate to run.

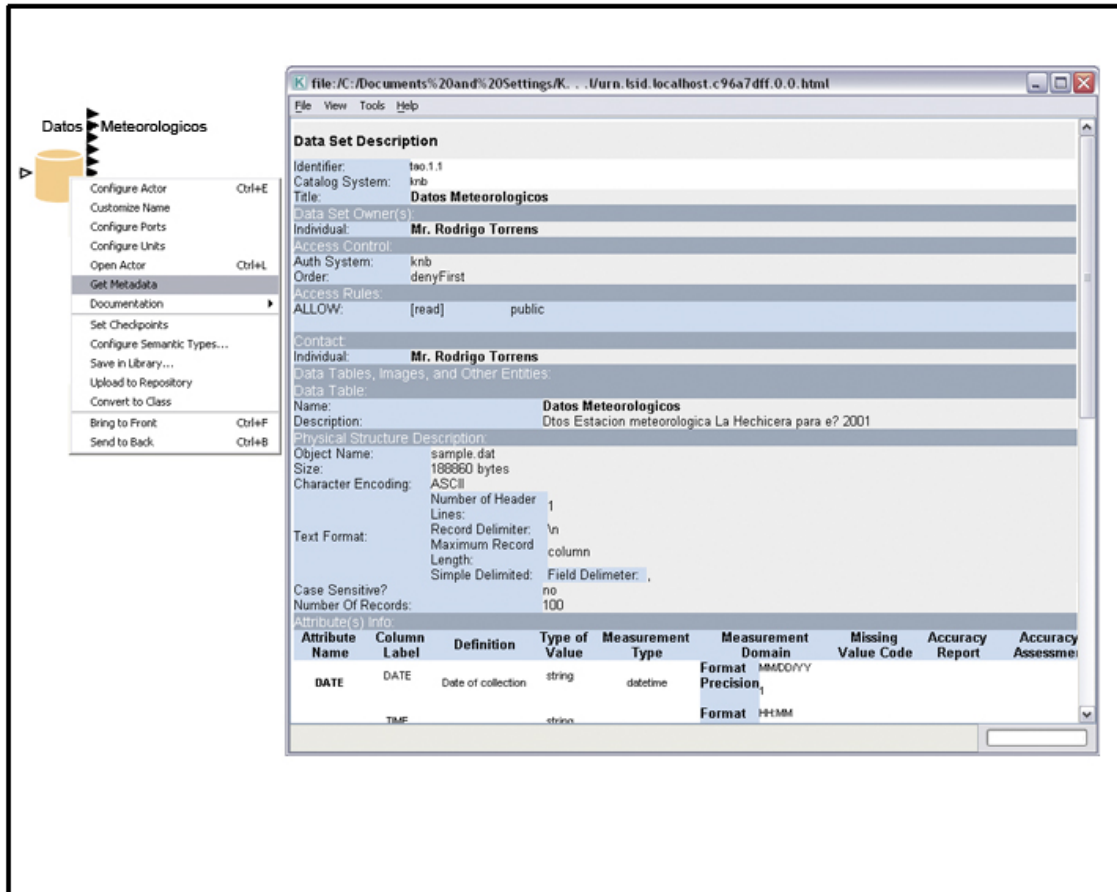

Figure 24: Viewing Metadata

- Right-click the *Datos Meteorologicos* actor and select Configure Actor. Select “As Column Vector” from the pull-down menu beside the Data Output Format parameter (*Figure 25*) and click Commit. (The data type of the *Datos Meteorologicos* actor must be set to “As Column Vector” to match the input requirements of the *RExpression* actor.)



Figure 25: Configuring *Datos Meteorologicos*

NOTE: *Datos Meteorologicos* has a series of output ports corresponding to the data attribute names (e.g., BARO and T_AIR). To locate the appropriate port, mouse-over the output ports and review the port tooltips (*Figure 26*).

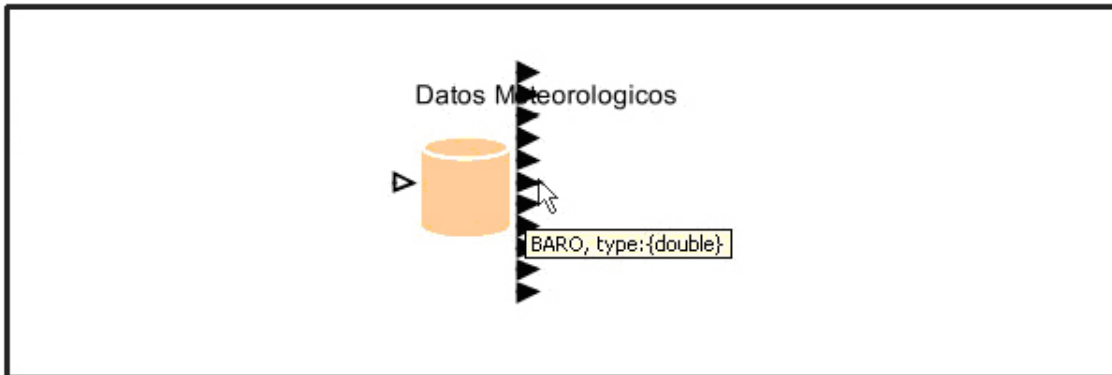

Figure 26: Identifying data ports. Mouse-over each output port to review the port tooltips.

To finish creating the workflow, add the *SDF Director* and the remaining actors (*RExpression*, *ImageJ*, *Display*).

7. Locate the *SDF Director* and drag and drop it to the Workflow canvas.
8. Configure the *SDF Director* by right-clicking it and selecting *Configure Director*. Change the number of iterations to 1.
9. Click *Commit* for the changes to take effect.
10. Locate the *RExpression* actor and drag and drop it to the Workflow canvas. The *RExpression* actor is located in the “General Purpose” folder.

By default, the *RExpression* actor is configured with two output ports and the R script 2+2. Before you can use the *RExpression* actor in the Simple Linear Regression workflow, you must add two input ports (T_AIR and BARO) and reconfigure the *RExpression* script.

11. Right-click the *RExpression* actor and select *Configure Ports*.

12. In the “Configure ports” dialogue box, click Add twice to add two new ports. Designate the new ports as input ports by clicking the checkbox named Input beside each port.
13. Name the new input ports by double-clicking the blank box in the Name column. Add the name “T_AIR” for one input and “BARO” for the other. Click Commit to save the changes (*Figure 27*).

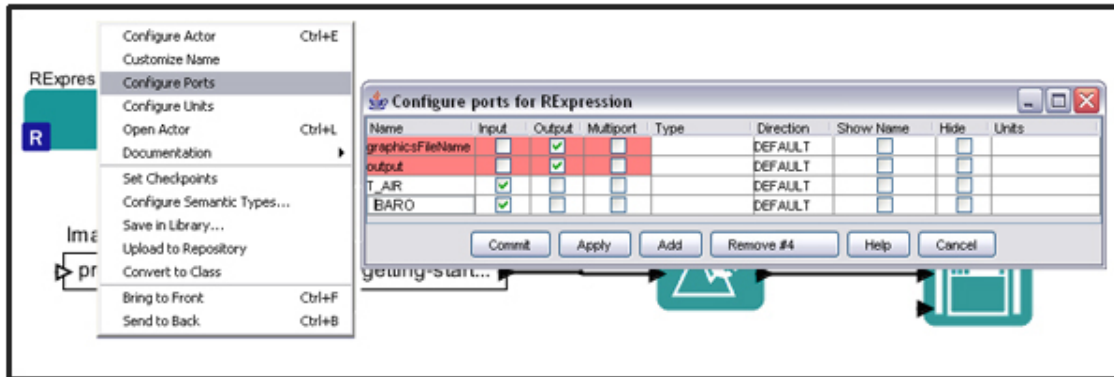

Figure 27: Adding and customizing ports

14. To configure the R script, right-click the *RExpression* actor and select Configure Actor. In the “R function or script” dialogue box, change the value of the R function or script from the default to the following:

```
res <- lm(BARO ~ T_AIR)

res

plot(T_AIR, BARO)

abline(res)
```

The above R function tells the *RExpression* actor to read the Barometric Pressure and Air Temperature data and then plot the values along with a regression line. Click Commit to save your changes .

15. Drag and drop the text *Display* actor to the Workflow canvas. The *Display* actor is located under “Components> Data Output > Workflow Output > Textual Output.”
16. Connect the lower output port of the *RExpression* actor to the input port of the *Display* actor.
17. Drag and drop the *ImageJ* actor to the Workflow canvas. The *ImageJ* actor is located under “Components > Data Output > Workflow Output > Graphical Output.”

Connect the upper output port of the *RExpression* actor to the input port of the *ImageJ* actor. You are now ready to run the workflow. The resulting workflow and graphic output are shown below (*Figure 28*).

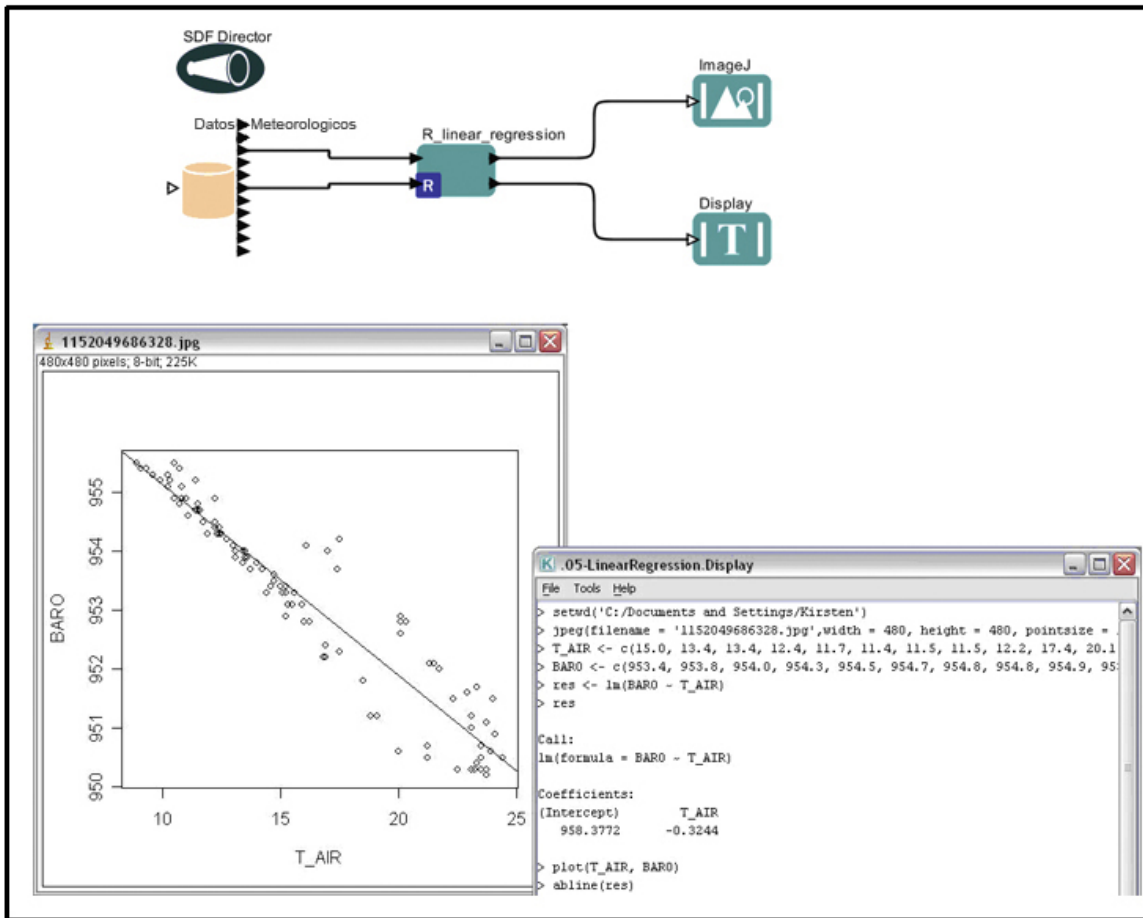

Figure 28: Linear Regression workflow and its output

The left-hand window in *Figure 28* displays the scatter plot of Barometric pressure to Air Temperature along with a regression line. The graph shows a strong negative relationship between the two: as air temperature lowers, the Barometric pressure rises. The right-hand window displays the Barometric Pressure and Air Temperature data used in the scatter plot. Additionally, the intercept on the Y-axis (958.38 Barometric Pressure and the slope -0.32 for the linear regression equation $y=mx+b$) is displayed.

You can change the data type and the data set that is run through the workflow. When changing the data, remember to make sure that the data meets the assumptions mentioned in workflow table at the beginning of Section 7.2.

7.3. Sample Workflow 3 – Web Services and Data Transformation

Name	Web Services and Data Transformation Workflow
File name	06-WebServicesAndDataTransformation.xml

Detailed Description	This workflow uses the remote genomics data service to retrieve a genetic sequence for a given gene accession number. The sequence is then displayed in three different ways after appropriate transformations: first in its native format (XML), second as a sequence of elements extracted from the XML format, and third as an HTML document that can be used for display on a website. The later two operations are performed using composite actors that hide some of the complexity of the underlying operations. Composite actors can be thought of as “sub-workflows” that execute a potentially complex set of tasks with a single actor.
Assumptions	The <i>Web Service</i> actor assumes that the target Web service is RPC-based and uses primitive XML types and arrays.
Director	<i>SDF Director</i>
Data	The data consists of an initial input gene accession number that is specified by the <i>String Constant</i> actor and an intermediate input retrieved from the remote genomics data service.
Actors	<i>String Constant, Display, Sequence Getter Using XPath, HTML Generator Using XSLT, Web Services,</i>
Parameters	<i>Web Services:</i> wsdlUrl= http://xml.nig.ac.jp/wsdl/DDBJ.wsdl <i>Web Services: methodName=getXMLEntry</i>

The Web Services and Data Transformation workflow uses the *Web Service* actor to access a genomics database and return a genetic sequence from it, which is queried using a remote genomics data service. The name of the returned genetic sequence (i.e., the gene accession number) is passed to the *Web Services* actor by a *String Constant* actor. The *Web Service* actor must be configured to access the appropriate remote server. Once configured, the *Web Service* actor outputs the gene sequence obtained from the remote server so that it can be displayed in multiple formats using three different textual *Display* actors: one for XML (the format in which the results are returned by default), one for a sequence of elements extracted from the XML, and one for an HTML document that can be displayed on a website.

A Relation is used to “branch” the data output by the *Web Service* actor so that it can be shared by all of the necessary components.

The workflow uses two composite actors: *Sequence Getter Using XPath* and *HTML Generator Using XSLT* to process the returned XML data and convert it into a sequence of elements and an HTML file, respectively. These actors have been created for use with

this workflow using existing Kepler actors. *Sequence Getter Using XPath* and *HTML Generator Using XSLT* do not appear in the Components tab. To see the “insides” of the composite actors, right-click the actor icon on the Workflow canvas and select Open Actor from the menu. The composite actor will open in a new application window. See *Figure 32* for an example.

In addition, the workflow uses a fourth *Display* actor to display errors returned by the remote server (e.g., server down or incorrect input).

To create the Web Services workflow:

1. Open a new Workflow canvas.
2. Drag and drop the *SDF Director* onto the Workflow canvas.
3. Drag and drop the *String Constant* actor onto the Workflow canvas.
4. Right-click the *String Constant* actor and select Configure Actor. Type AA045112 (the gene accession number) into the value field and click Commit.
5. To change the name of the *String Constant* actor, right-click it and select Customize Name. Type a new name (e.g., Gene Accession Number) into the New name field and click Commit (*Figure 29*).

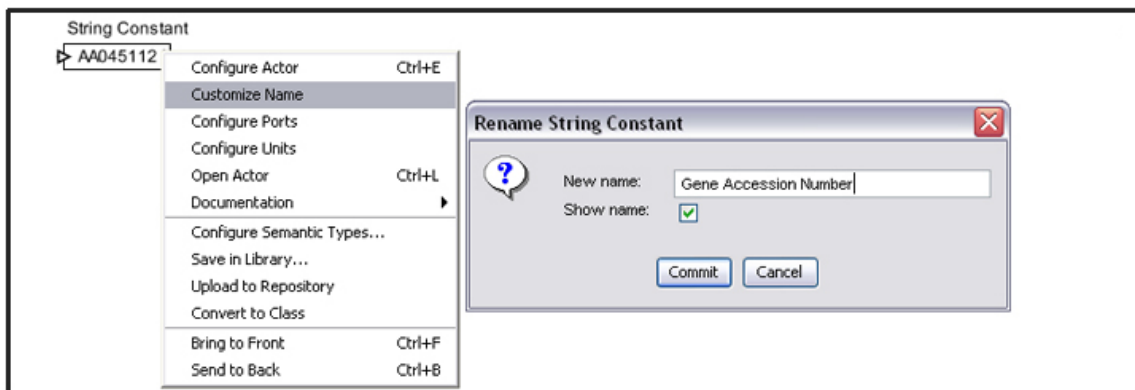

Figure 29: Customizing the name of an actor

6. Drag and drop the *Web Service Actor* onto the Workflow canvas. Place the actor beneath the *String Constant* actor. By default, the *Web Service Actor* has one output port for displaying runtime errors and must be configured with a Web service URL (a `wsdlUrl` parameter), an appropriate method (a `methodName` parameter). Once the actor has been configured with this information, it will automatically generate the correct input and output ports required by the Web service.
7. To configure the parameters required for accessing the Web service, right-click the *Web Service Actor* and select Configure Actor (*Figure 30*). Type

<http://xml.nig.ac.jp/wsd/DBJ.wsd> into the `wsdUrl` field. In the `methodName` field, type `getXMLEntry`. Click commit. The *Web Service Actor* ports should update automatically. You can move the ports so that they are more conveniently located by right-clicking the actor and selecting a desired port direction from the Configure Ports dialog box.

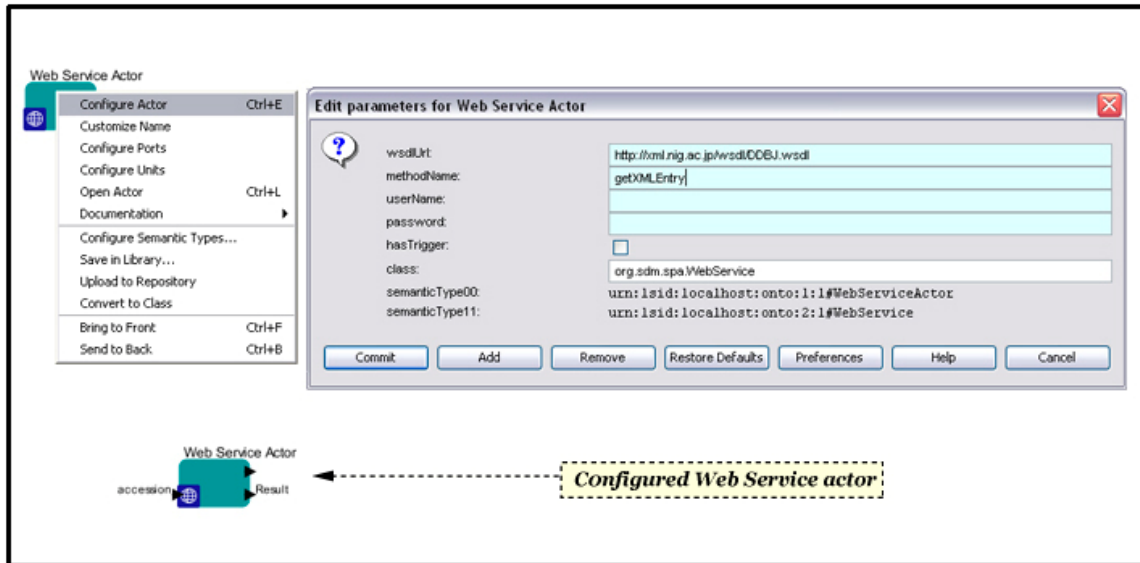

Figure 30: Configuring the *Web Service Actor*

8. Connect the output of the *String Constant* actor (Gene Accession Number) to the input of the *Web Service Actor*.
9. Drag and drop four *Display* actors onto the Workflow canvas.
10. Position one of the *Display* actors beneath and to the right of the *Web Service Actor*. Right-click the actor and change the name to “Errors Sink.”
11. Connect the lower output port of the *Web Service Actor* to the input port of the “Errors Sink” *Display* actor.
12. Position the second *Display* actor to the right and slightly above the *Web Service Actor*. Right-click the actor and change the name to “XML Entry Display.”

The Web Services and Data Transformation workflow uses two component actors designed specifically for this workflow. These customized actors are not available in the Component library, and rather than recreating them, we will save some time by copying and pasting them from the existing workflow.

13. Open the Web Services and Data Transformation workflow (06-WebServicesAndDataTransformation.xml) from Kepler's "/demos/getting-started" directory. The workflow will open in a new application window. Select the *Sequence Getter Using XPath* composite actor by left-clicking it.
14. From the Edit menu, select Copy (or use the keyboard shortcut Ctrl+C).

- Return to your workflow and paste the *Sequence Getter Using XPath* actor to the right of the *Web Service Actor* using the Paste command available in the Edit menu (Figure 31) or the keyboard shortcut Ctrl+V.

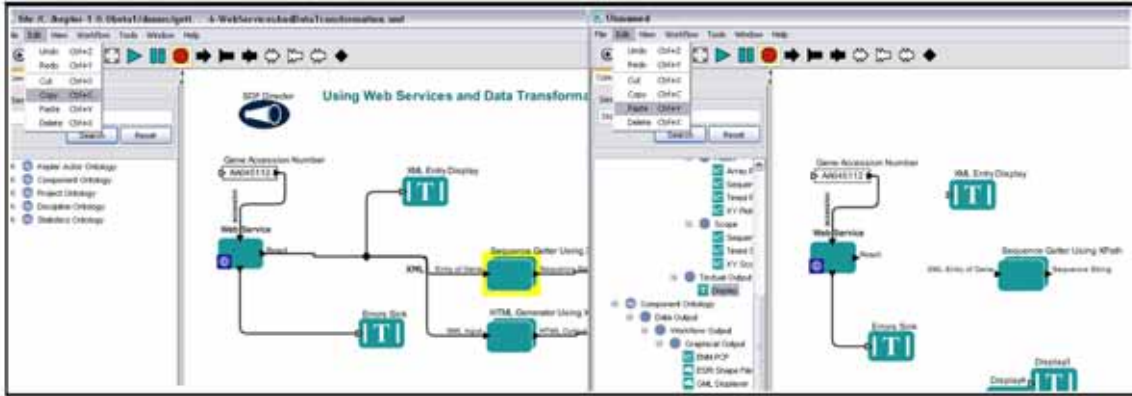

Figure 31: Copying and pasting actors between workflows.

- Copy and paste the *HTML Generator Using XSLT* actor from the Web Services and Data Transformation workflow into your workflow.

NOTE: To view the insides of a composite actor, right-click the actor and select Open Actor from the menu. The composite actor will open in a new application window (Figure 32). Composite actors can be thought of as “sub-workflows” that execute a potentially complex set of tasks with a single actor.

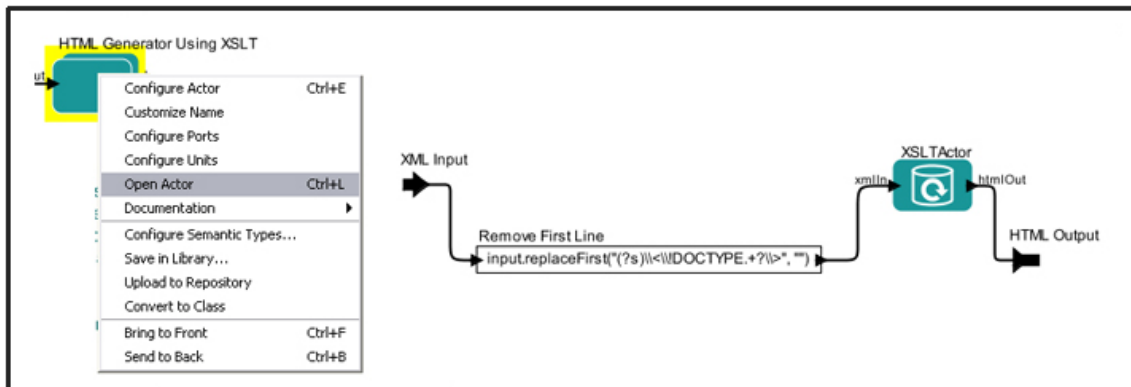

Figure 32: Inside the *HTML Generator Using XSLT* composite actor.

Because the *Web Service Actor* output is required by three actors, before connecting your actors, you must add a relation to direct the output to multiple ports.

- Add a relation by clicking the Relation icon at the far right of the Toolbar. The relation (represented by a dark diamond icon) will appear near the center of the Workflow canvas (Figure 33). You can also add a relation with the keyboard shortcut Ctrl-click.

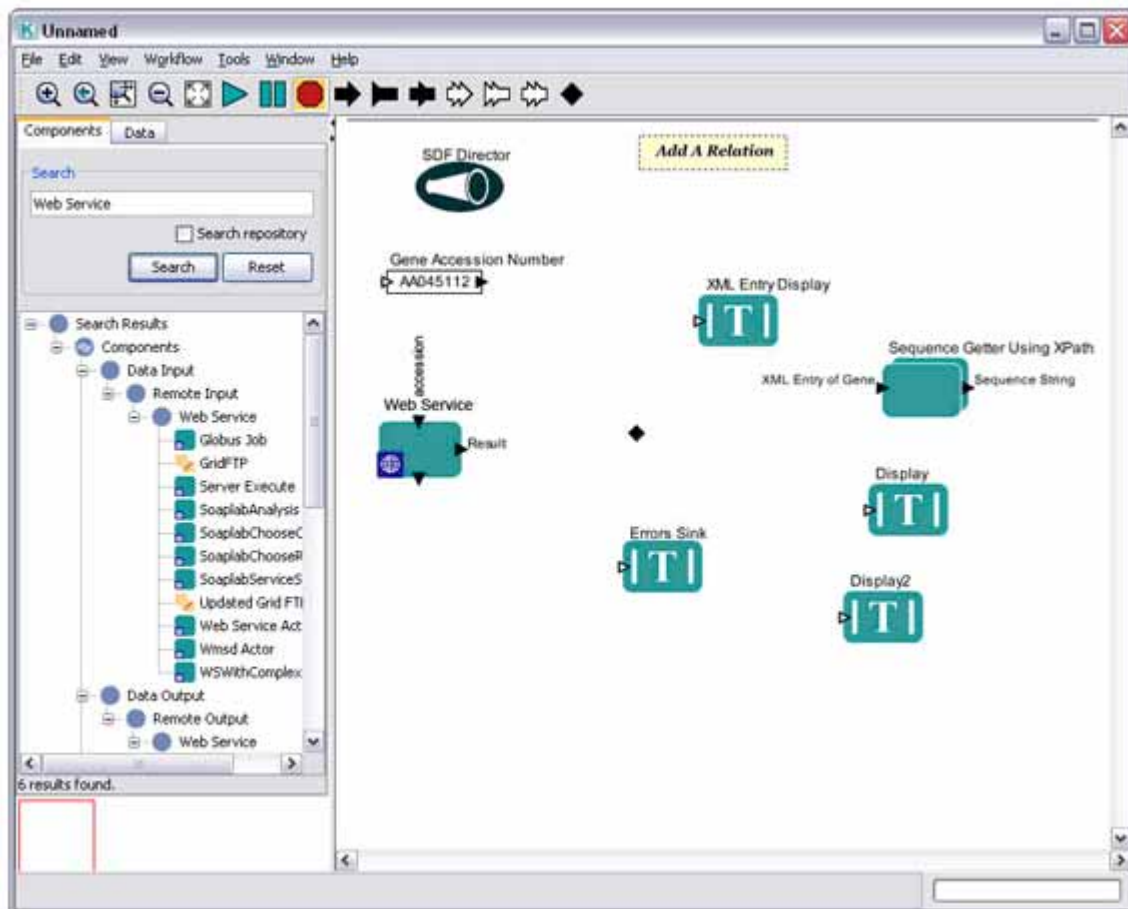

Figure 33 Adding a relation

18. Position the Relation icon between the *Web Service* actor and the *Sequence Getter using XPath* actor.
19. Connect the input port of the “XML Entry Display” *Display* actor to the output of the *WebService* actor. To make the connection, start from the input port of the *Display* actor and drag the cursor to the center of the Relation icon.
20. Connect the *HTML Generator Using XSLT* actor and the *Sequence Getter Using XPath* actor to the Relation icon as well.
21. Rename the third *Display* actor “Sequence String Display” and position it to the right of the *Sequence Getter using XPath* actor.
22. Connect the input of the “Sequence String Display” actor to the output of the *Sequence Getter using XPath* actor.
23. Rename the fourth *Display* actor “HTML Display” and position it to the right of the *HTML Generator Using XSLT* actor.
24. Connect the input of the “HTML Display” actor to the output of the *HTML Generator Using XSLT* actor.

You are now ready to run the workflow. The resulting workflow and output are shown below (Figure 34).

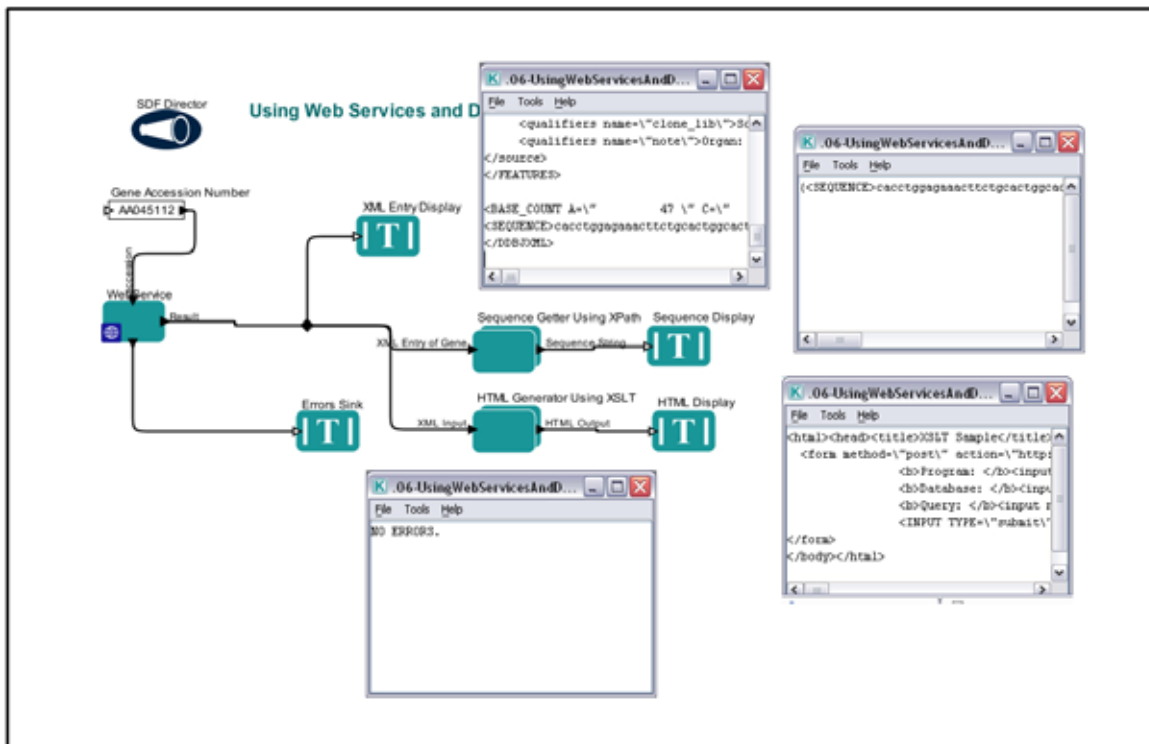

Figure 34: The Web Services workflow

NOTE: To add an annotation to your workflow, drag-and-drop the *Annotation* actor onto the Workflow canvas. Double-click the default text (“Double click to edit”) to customize the annotation.

7.4. Sample Workflow 4 – Execute an External Application from Kepler (*ExternalExecution* actor)

The *ExternalExecution* actor can be used to launch an external application from within a Kepler workflow. The actor can pass values to the application and return values that can be used or displayed by downstream actors. In order to use the *ExternalExecution* actor, the invoked application must be on the local computer and, in some cases, configured appropriately. In this section, we will look at several examples of workflows that use the *ExternalExecution* actor.

Name	External Execution Workflow
File name	07-CommandLine_1.xml

Detailed Description	The 07-CommandLine_1.xml workflow uses Kepler's <i>ExternalExecution</i> actor to execute the HelloWorld Java application that is shipped with Kepler. The actor outputs the application's return, which is displayed by a <i>Display</i> actor.
Assumptions	The HelloWorld Java application is installed on the local machine in Kepler's /demos/getting-started directory.
Director	<i>SDF Director</i>
Data	Data is generated in two <i>Constant</i> actors
Actors	<i>Constant</i> actor (<i>CommandLine</i>), <i>CommandLineExec</i> , and <i>Display</i>
Parameters	<i>CommandLineExec</i> actor: directory=\$WorkingDir waitForProcess parameter is selected

The Command Line 1 workflow uses Kepler's *ExternalExecution* actor to execute the HelloWorld application that ships with Kepler. The HelloWorld application is a simple Java program that outputs a string consisting of the text "Hello" plus a variable (usually a user name, and by default the string "Kepler_User"). The *ExternalExecution* actor waits for the HelloWorld application to finish executing, and then returns the application output, which is displayed by a *Display* actor.

The *ExternalExecution*'s `directory` parameter is configured to the location of the HelloWorld application. All other parameters are left at the default settings.

To create the Command Line 1 workflow:

1. Drag and drop an *SDF Director* onto the Workflow canvas and configure the `iterations` parameter to 1.
2. Drag and drop a *Constant* actor onto the Workflow canvas. Name the actor "CommandLine" To name the actor, right-click each actor icon and select "Customize Name" from the drop-down menu. Enter a new name in the "New name" field and click Commit. The name will be updated on the Workflow canvas.
3. Double-click the *CommandLine* actor to open its parameters. Specify "java -cp ./ HelloWorld Kepler_User" as the value. 'java -cp ./ HelloWorld' is the command that runs the Java application 'HelloWorld'. The '-cp ./' part of the command tells Java to include the current directory in the Java classpath). 'Kepler_User' is an argument passed to the command line, and its value can be varied to as desired (e.g., Katie or Bob). Note that the surrounding quotation marks around the entire value are required to indicate that it is a string. Click the Commit button.

4. Search for "Parameter" in the Component library, and then drag and drop a workflow Parameter to the Workflow canvas. Right-click the parameter and select Customize Name from the drop-down menu. Name the parameter WorkingDir and click Commit. Double-click the parameter to set its value to the parameter to `property("KEPLER")+ " /demos/getting-started"` (i.e., the location of the working directory).
5. Drag and drop an *ExternalExecution* actor onto the Workflow canvas. Double-click the icon and set the value of the `directory` parameter to `WorkingDir` (i.e., the value of the `WorkingDir` parameter set on the Workflow canvas). (Figure 35)

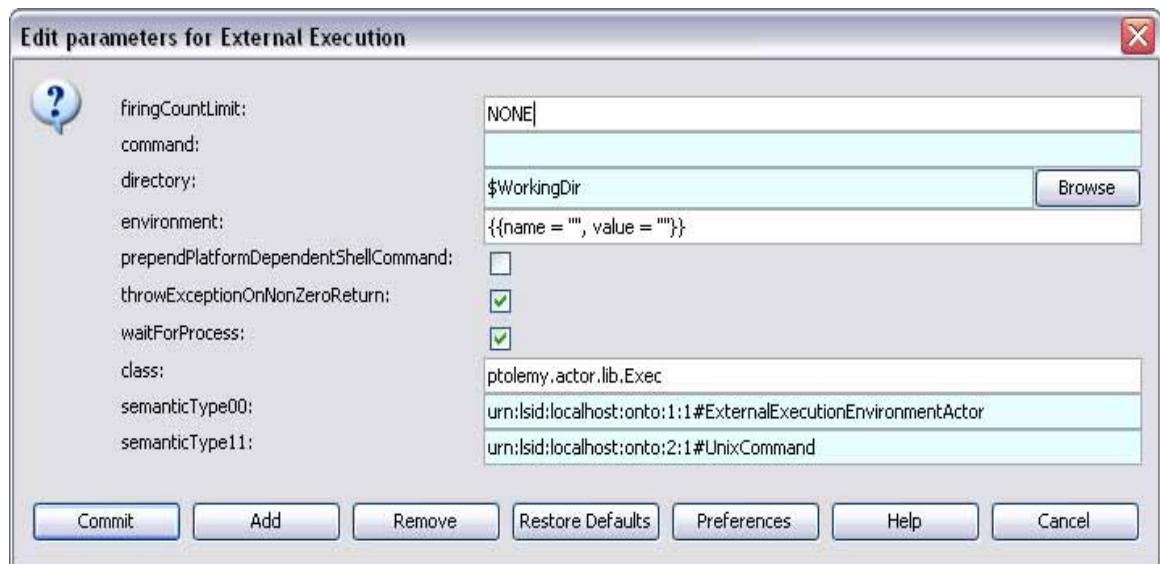

Figure 35: Set the `directory` parameter of the *ExternalExecution* actor for use with this workflow.

6. Connect the output port of the *CommandLine* actor to the `command` input port of the *ExternalExecution* actor.
7. Drag and drop a *Display* actor onto the Workflow canvas and connect its input port to the *ExternalExecution* actor's output port.
8. You are now ready to run the workflow. The workflow and its default output are displayed in Figure 36.

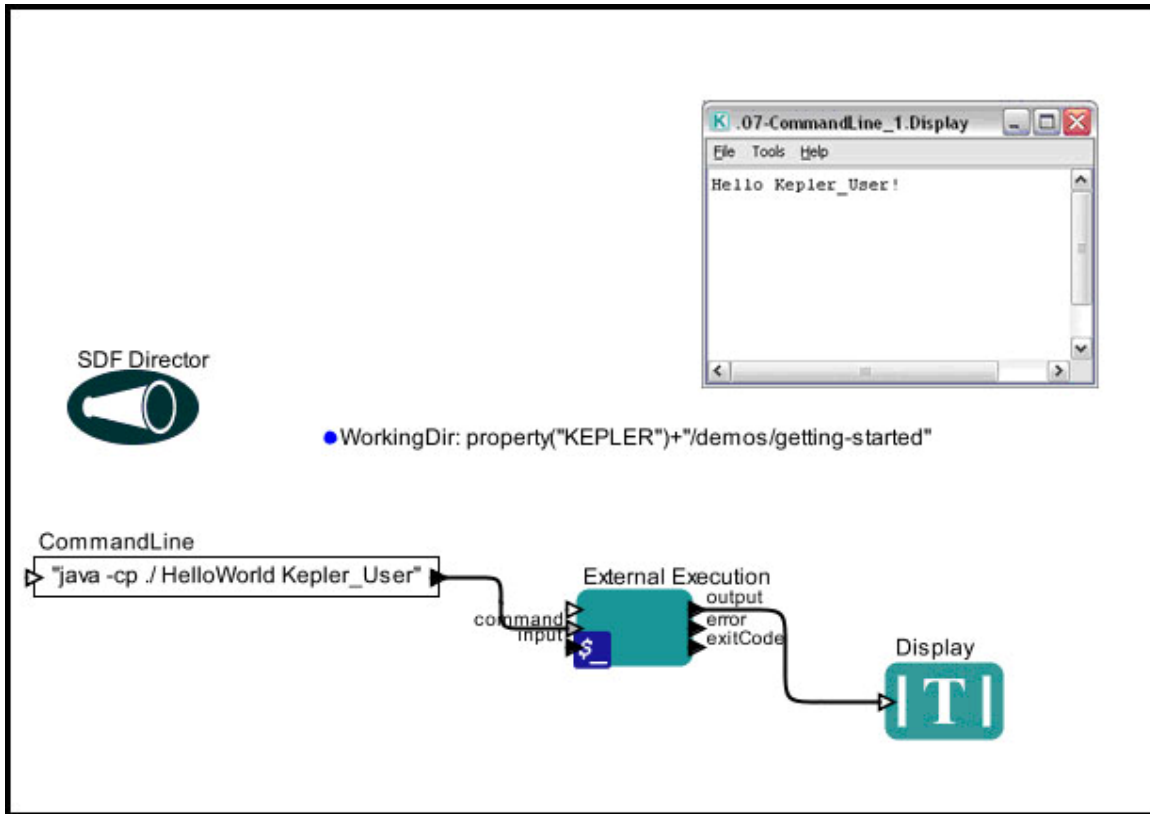

Figure 36: The Command Line workflow and its default output.

8. Appendix

8.1. Ptolemy II – The Foundation of Kepler

Ptolemy II is a software framework for heterogeneous, concurrent modeling and design, with a Java-based component assembly framework using a graphical interface called Vergil. The Ptolemy II software is a product of the Ptolemy project at the University of California at Berkeley, a project whose goal is “the use of well-defined models of computation that govern the interactions between components.”

As explained at the project’s website, Ptolemy II includes a number of *domains*, each of which realizes a model of computation. It also includes a component library and a number of support packages such as graphing, mathematics, plot, and data packages. For more information about Ptolemy II, see <http://ptolemy.eecs.berkeley.edu/index.html>.

Although not originally intended for scientific workflows, Ptolemy II provides support for dataflow-oriented models, which is a very important characteristic of scientific workflows. Because Ptolemy II provides an open-source, mature platform for model design and execution, including various models of computation, and is well documented and easily extensible, it was chosen as the foundation for Kepler.

8.2. Actor Reference

Documentation for actors and directors is available in the [Actor Reference](#). Additionally, this documentation is available within the Kepler interface. To get documentation:

1. Right-click the actor or director
2. Select Documentation
3. Then select Display. (Figure 37)

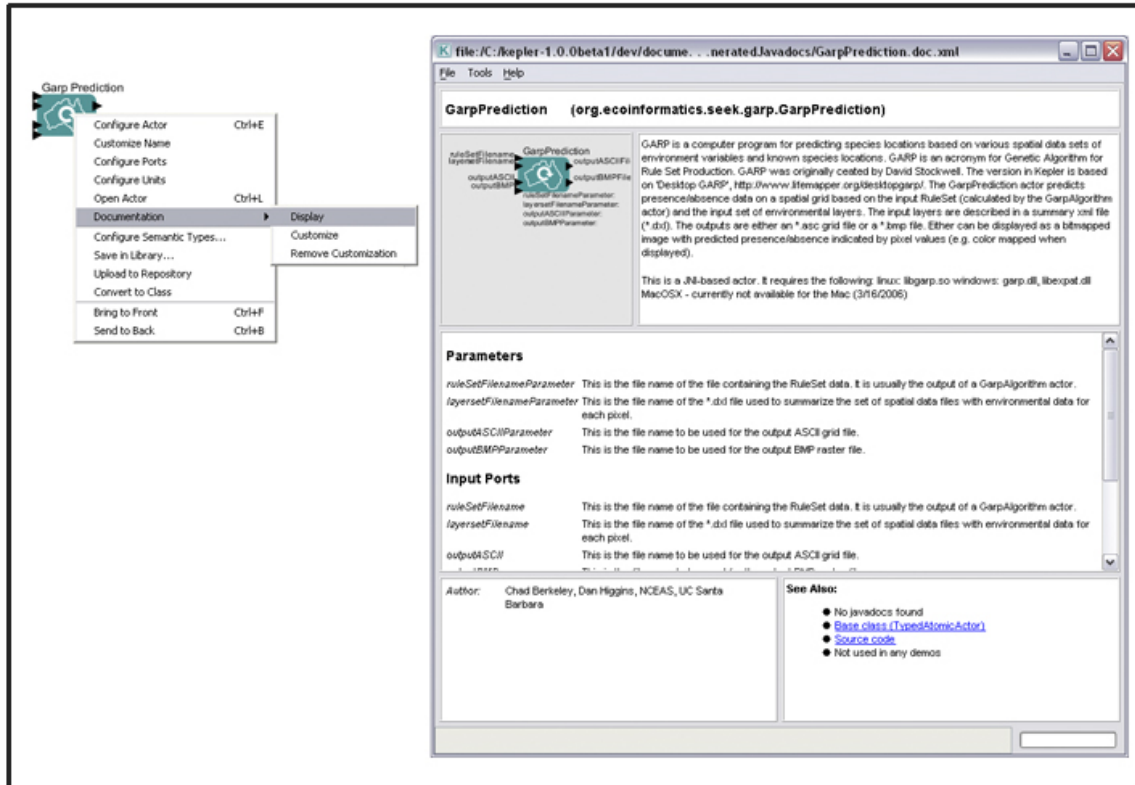

Figure 37: Actor documentation