

Kepler User Manual



Version 2.1.0
October, 2010

1. Introduction to Kepler	6
1.1 What is Kepler?	6
1.1.1 Features	9
1.1.2 Architecture.....	11
1.2 History of the Kepler Project	13
1.3 Kepler Code Contributors	15
1.4 Future Goals	16
1.5 Participating in Kepler Development	18
Using Eclipse.....	20
Contributing to Kepler.....	21
1.6 Reporting Bugs	21
1.7 Further Reading	21
2. Installing and Running Kepler	23
2.1 System Requirements	23
2.2 Installing Kepler	23
2.2.1 Installing on Windows.....	23
2.2.3 Installing on Macintosh.....	25
2.2.4 Installing on Linux.....	25
2.3 Starting Kepler	26
2.4 The User Interface.....	27
2.4.1 Menu Bar	28
2.4.2 Toolbar.....	32
2.4.3 Components, Data Access, and Outline Areas.....	34
2.4.4 Workflow Canvas	39
2.4.5 Navigation Area.....	41
3. Scientific Workflows.....	43
3.1 What is a Scientific Workflow?.....	44
3.2 Components of a Workflow	45
3.2.1 Directors.....	46
3.2.2 Actors.....	48
3.2.3 Composite Actors.....	54
3.2.4 Ports.....	54
3.2.5 Channels and Tokens	59
3.2.6 Data Types.....	60
3.2.7 Relations.....	62
3.2.8 Parameters	63
4. Working with Existing Scientific Workflows.....	67
4.1 Opening Workflows	67
4.1.1 Opening Local Workflows.....	67
4.1.2 Opening Remote Workflows.....	69
4.2 Running Workflows	71
4.2.1 Runtime Window	71
4.2.2 Run Button.....	73
4.2.3 Running Workflows with Adjusted Parameters	74
4.3 Modifying Workflows	78
4.3.1 Substituting Data Sets.....	79

4.3.2 Substituting Analytical Components	86
4.4 Saving Workflows	89
4.5 Searching for Data and Components.....	89
4.5.1 Searching for Available Data	89
4.5.2 Searching for Standard Components	92
4.5.3 Searching for Components in the Kepler Repository	93
5. Building Workflows with Existing Actors.....	96
5.1 Prototyping Workflows	97
5.2. Choosing a Director	100
5.2.1 Synchronous Dataflow (SDF).....	104
5.2.2 Process Networks (PN)	108
5.2.3 Discrete Events (DE)	110
5.2.4 Continuous Time (CT)	111
5.2.5 Dynamic Dataflow (DDF).....	115
5.3 Using Existing Actors.....	120
5.3.1 Using Actors from the Standard Component Library.....	120
5.3.2 Instantiating Actors Not Included in the Standard Library	121
5.3.3 Using the Kepler Analytical Component Repository.....	124
5.3.4 Saving Actors to Your Library	126
5.3.5 Importing Actors as KAR Files.....	128
5.3.6 Actor Icon Families	128
5.4 Using Composite Actors.....	137
5.4.1 Benefits of Composite Actors.....	139
5.4.2 Creating Composite Actors.....	140
5.4.3 Saving Composite Actors.....	145
5.4.4 Combining Models of Computation	146
5.5 Using the ExternalExecution Actor to Launch an External Application	146
5.6 Iterating and Looping Workflows	157
5.6.1 Iterating with the SDF Director.....	158
5.6.2 Using Ramp and Repeat Actors	159
5.6.3 Using Arrays Instead of Iterating.....	162
5.6.4 Iterating with Higher-Order Composites.....	165
5.6.5 Creating Feedback Loops.....	166
5.7 Documenting Workflows	168
5.7.1 Annotation Actors.....	168
5.7.2 Documentation Menu	168
5.8 Debugging Workflows.....	169
5.8.1 Animating Workflows.....	169
5.8.2 Exceptions	170
5.8.3 Checking System Settings.....	171
5.8.4 Listening to the Director.....	172
5.9 Saving and Sharing Workflows	173
5.9.1 Saving and Sharing Your Workflows as KAR or XML Files.....	173
5.9.2 Opening and Running a Shared XML Workflow	174
6. Working with Data Sets	176
6.1 Data Actors.....	176
6.2 Using Tabular Data Sets with Metadata	178
6.2.1 Viewing Metadata.....	186
6.2.2 Outputting Data for Use in a Workflow	186

6.2.3 Querying Metadata	189
6.3 Using Tabular Data without Metadata	191
6.3.1 Comma- Tab-, Text-Delimited Files	192
6.3.2 Accessing Data from a Website	194
6.4 Accessing Data Access Protocol (DAP) Sources.....	196
6.5 Using FTP.....	197
6.6 Using Data Stored in Relational Databases.....	198
6.7 Using Spatial and Image Data	201
6.7.1 Working with Images	202
6.7.2 Working with Spatial Data.....	206
6.8 Using Gene and Protein Sequence Data	209
7. Using Remote Computing Resources: The Cluster, Grid and Web Services	211
7.1 Data Movement and Management	212
7.1.1 Saving and Sharing Data on the EarthGrid	212
7.1.2. Secure Copy (scp).....	214
7.1.3 GridFTP.....	216
7.1.4 Storage Resource Broker (SRB)	219
7.1.5 Integrated Rule-Oriented Data System (iRODS)	224
7.2 Remote Service Execution	225
7.2.1 Using Web Services	225
7.2.2 Using REST Services	230
7.2.2 Using Soaplab Services.....	231
7.2.3 Using Opal Services.....	234
7.3 Job Submission	236
7.3.1 Cluster Job Submssion	236
7.3.2 Grid Job Submission.....	238
8. Mathematical, Data Analysis, and Visualization Packages	245
8.1 Expressions and the Expression Actor	245
8.1.1 The Expressions Language	246
8.1.2 Expressions and Parameters	259
8.1.3 Expressions and Port Parameters	259
8.1.4 Expressions and String Parameters	261
8.1.5 The Expression Actor	261
8.2 Statistical Computing: Kepler and R	265
8.2.1 What is R?	266
8.2.2 Installing R.....	266
8.2.3 Useful R Actors	267
8.2.4 Working with R Actors.....	268
8.3 Statistical Computing: MATLAB.....	281
8.4 Image Manipulation: ImageJ.....	283
8.4.1 Intro to ImageJ and the ImageJ Actor.....	284
8.4.2 The IJMacro Actor.....	291
8.5 Spatial Data: Geographic Information Systems (GIS).....	293
8.5.1 Masking a Geographical Area with the ConvexHull and CVToRaster Actors.....	294
8.5.2 Geospatial Data Abstraction Library (GDAL) Actors.....	295
9. Domain Specific Workflows	299
9.1 Chemistry	299

9.2 Ecology	300
9.3 Geology.....	302
9.4 Molecular Biology.....	304
9.5 Oceanography	305
9.6 Phylogeny.....	306
Appendix A: Creating New Actors	308
A.1 Building a Custom Actor Based on an Existing Actor	308
A.2 Creating a New Actor by Extending a Java Class	310
A.2.1 Coding a New Actor	311
A.2.2 Compiling a New Actor.....	322
A.4 Sharing an Actor: Creating a KAR File	322
A.4.1 The Manifest File.....	322
A.4.2 The MOML File.....	323
Appendix B: Modules.....	324
11.1 The Module Manager	324
11.2 Developing Modules.....	326
10. Appendix C: Using R in Kepler	327
C.1 Installing R	327
C.2 A Brief Overview of R.....	327
C.2.1 Data Objects.....	329
C.2.2 Functions.....	330
C.2.3 Further Resources.....	330
C.3 The REXpression Actor	331
C.3.1 Inputs.....	332
C.3.2 Outputs.....	335
C.4 Handling Data	339
C.4.1 Inputting Data.....	339
C.4.2 Outputting Data.....	355
C.5 Example R Scripts and Functions	358
C.5.1 Simple Linear Regression.....	358
C.5.2 Basic Plotting.....	359
C.5.3 Summary Statistics	361
C.5.4 3D Plotting.....	362
C.5.5 Biodiversity and Ecological Analysis and Modeling (BEAM)	363
C.5.6 Random Sampling.....	366
C.5.7 Custom REXpression Actors.....	367
11. Appendix: Glossary.....	379

1. Introduction to Kepler

Scientists in a variety of disciplines (e.g., biology, ecology, astronomy) need access to scientific data and flexible means for executing complex analyses on those data. Such analyses can be captured as *scientific workflows* in which the flow of data from one analytical step to another is captured in a formal workflow language. The Kepler project's overall goal is to produce an open-source scientific workflow system that allows scientists to design scientific workflows and execute them efficiently either locally or through emerging Grid-based approaches to distributed computation.

1.1 What is Kepler?

Kepler is a software application for the analysis and modeling of scientific data. Using Kepler's graphical interface and components, scientists with little background in computer science can create executable scientific workflows, which are flexible tools for accessing scientific data (streaming sensor data, medical and satellite images, simulation output, observational data, etc.) and executing complex analysis on the retrieved data (*Figure 1.1*).

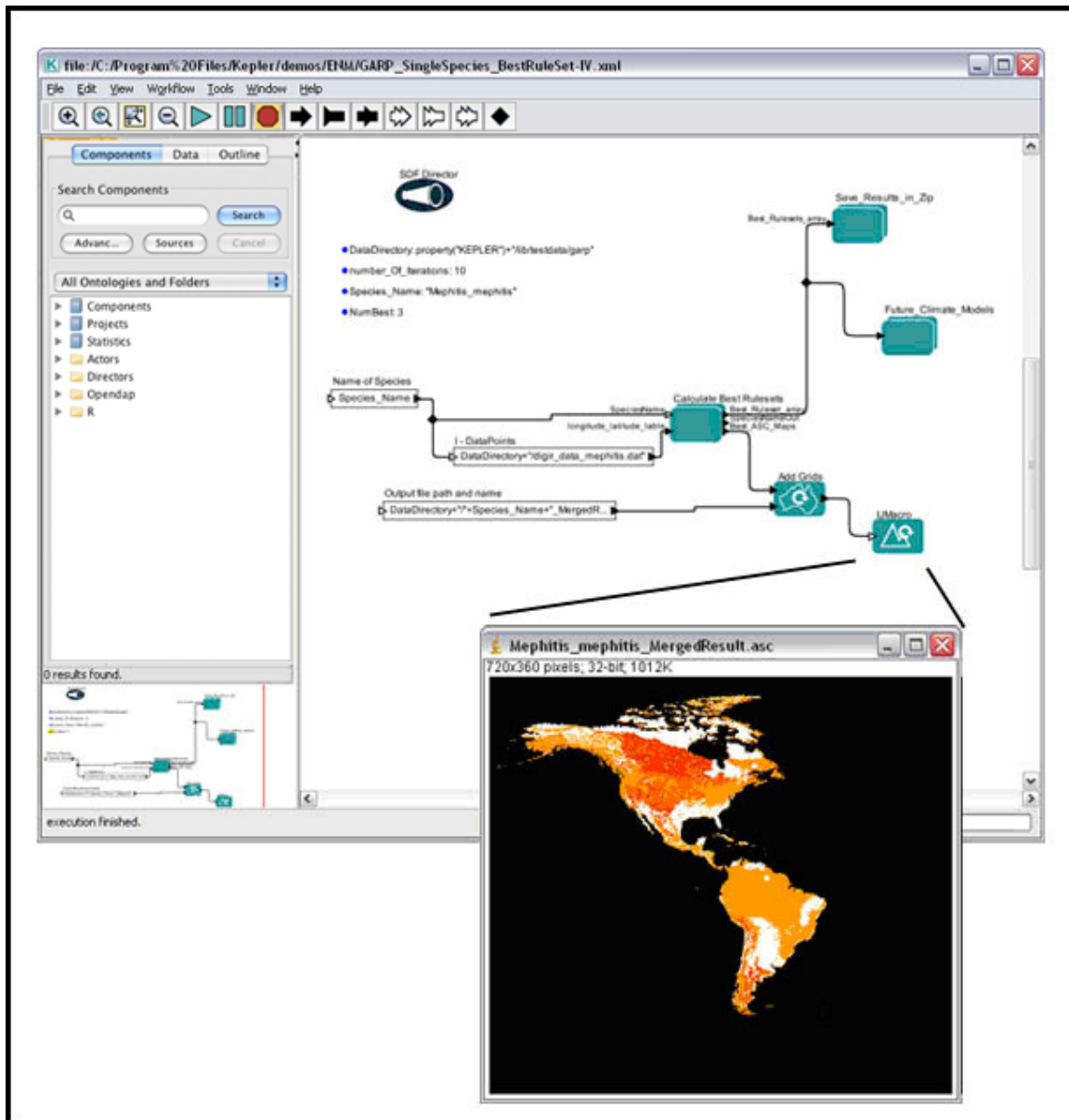

Figure 1.1 A scientific workflow (GARP_SingleSpecies_BestRuleSet-IV.xml) displayed in the Kepler interface. This workflow processes species occurrence data to create an ecological niche model.

Kepler includes distributed computing technologies that allow scientists to share their data and workflows with other scientists and to use data and analytical workflows from others around the world. Kepler also provides access to a continually expanding, geographically distributed set of data repositories, computing resources, and workflow libraries (e.g., ecological data from field stations, specimen data from museum collections, data from the geosciences, etc.) (Figure 1.2).

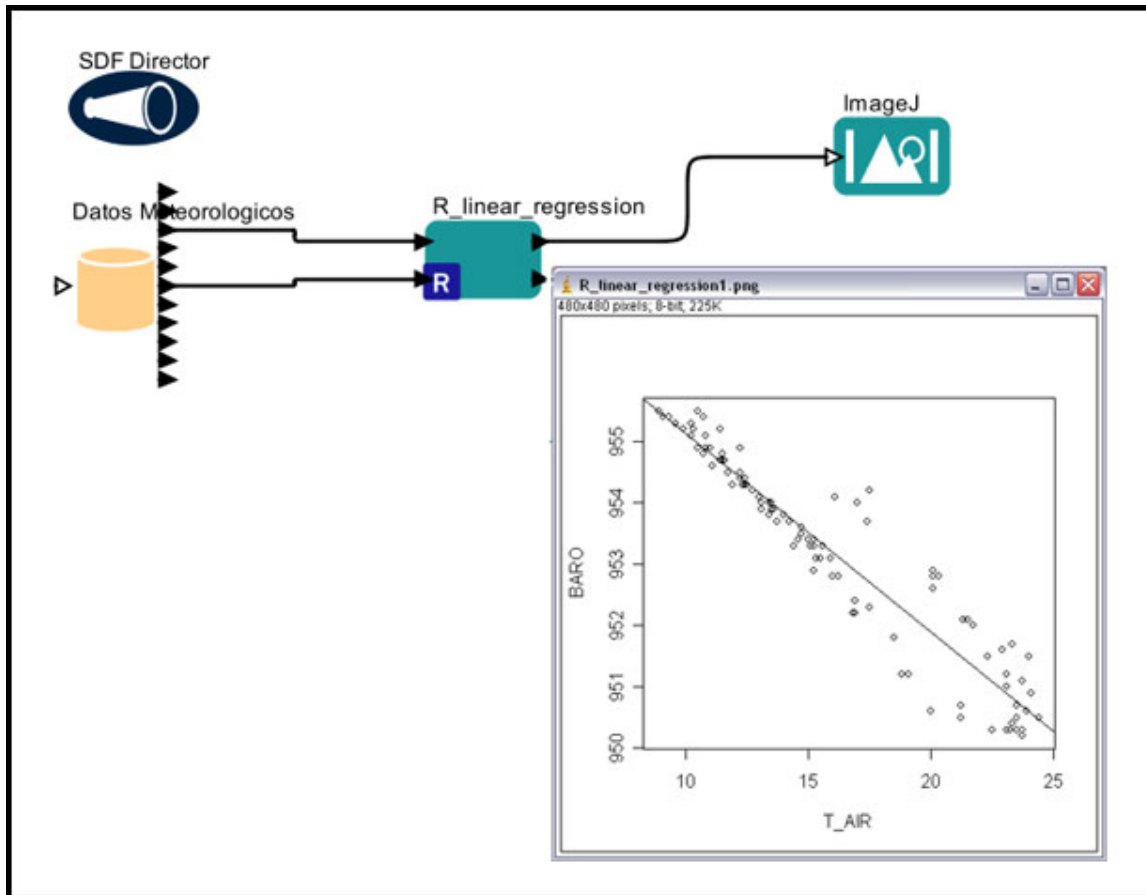

Figure 1.2: A workflow (eml-simple-linearRegression-R.xml) that performs and plots a simple linear regression on a meteorological data set stored remotely on the EarthGrid and accessed via a workflow actor.

The Kepler system aims at supporting very different kinds of workflows, ranging from low-level “plumbing” workflows of interest to Grid engineers, to analytical knowledge discovery workflows for scientists (*Figure 1.3*), and conceptual-level design workflows that might become executable only as a result of subsequent refinement steps.¹

¹ Ludäscher, B., I. Altintas, C. Berkley, D. Higgins, E. Jaeger-Frank, M. Jones, E. Lee, J. Tao, Y. Zhao. 2005. Scientific Workflow Management and the Kepler System, DOI: 10.1002/cpe.994

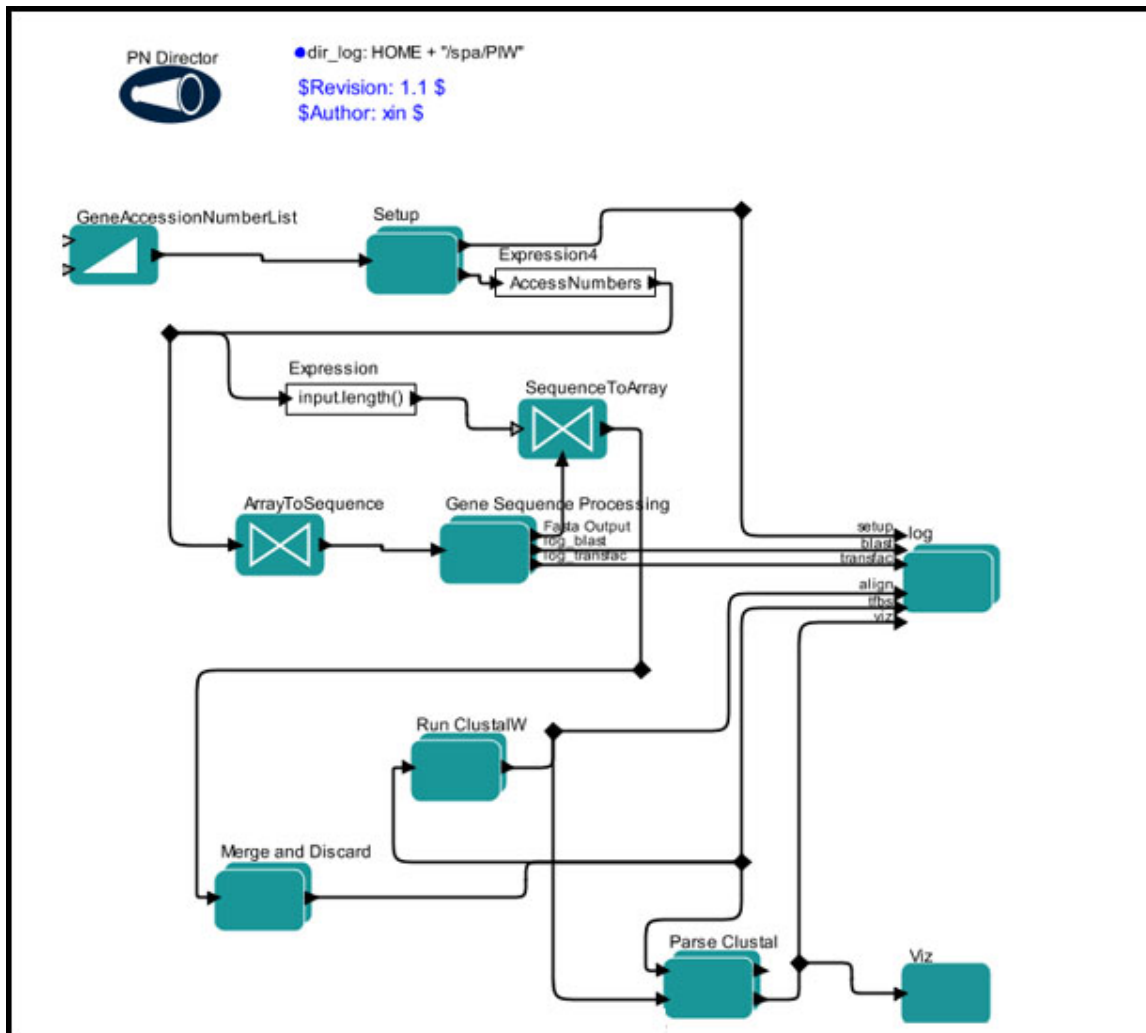

Figure 1.3: The Promoter Identification Workflow, a typical scientific knowledge discovery workflow that links genomic biology techniques such as microarrays with bioinformatics tools such as BLAST to identify and characterize eukaryotic promoters.

Kepler builds upon the mature [Ptolemy II framework](#), developed at the University of California, Berkeley. Other scientific workflow environments include academic systems such as [SCIRun](#), [Triana](#), [Taverna](#), and commercial systems ([Scitegic/Pipeline-Pilot](#), [Inforsense/Accelrys](#)).² For a detailed discussion of these and other workflow systems, please see <http://www.gridbus.org/reports/GridWorkflowTaxonomy.pdf>.

1.1.1 Features

Using Kepler, scientists can capture workflows in a format that can easily be exchanged, archived, versioned, and executed. Both Kepler's intuitive GUI (inherited from Ptolemy)

² Altintas, I, C. Berkley, E. Jaeger, M. Jones, B. Ludäscher, S. Mock, Kepler: An Extensible System for Design and Execution of Scientific Workflows, system demonstration, 16th Intl. Conf. on Scientific and Statistical Database Management (SSDBM'04), 21-23 June 2004, Santorini Island, Greece.

for design and execution, and its actor-oriented modeling paradigm make it a very versatile tool for scientific workflow design, prototyping, execution, and reuse for both workflow engineers and end users. Kepler workflows can be exchanged in XML using Ptolemy's own Modeling Markup Language (MoML). Kepler currently provides the following features:³

Access to Scientific Data: The Kepler component library contains an Ecological Metadata Language (EML) ingestion actor (*EML2Dataset*) used to access, download, and preview EML described data sources. The *EML2Dataset* actor allows Kepler to import a multitude of heterogeneous data, making it a very flexible tool for scientists who often deal with many data and file formats. A similar actor exists for Darwin Core-described data sets (*DarwinCoreDataSource*). In addition, Kepler's *ReadTable* actor allows users to access and incorporate data stored in Excel files.

Graphical User Interface: Users can build workflows via Kepler's intuitive graphical interface. Components are dragged and dropped onto a Workflow canvas, where they can be connected, customized, and then executed.

Distributed Execution (Web and Grid-Services): Kepler's Web and Grid service actors allow scientists to utilize computational resources on the net in a distributed scientific workflow. Kepler's generic *WebService* actor provides the user with an interface to seamlessly plug in and execute any WSDL-defined Web service. In addition to generic Web services, Kepler also includes specialized actors for executing jobs on the Grid, e.g., actors for certificate-based authentication (*SProxy* or *GlobusProxy*), Grid job submission (*GlobusJob*), and Grid-based data access (*GridFTP*). Third-party data transfer on the Grid can be established using *GridFTP* and *SRB* (Storage Resource Broker) actors.

Prototyping Workflows: Kepler allows scientists to prototype workflows before implementing the actual code needed for execution. Kepler's *Composite* actor can be used as a "blank slate" that prompts the scientist for critical information about an actor, e.g., the actor's name and port information.

Searchable Libraries: Kepler has a searchable library of actors and data sources (found under the Components and Data tabs of the application) with numerous reusable Kepler components and an ever-growing collection of data sets.

Database Access and Querying: Kepler includes database actors, such as the *DBConnect* actor, which emits a database connection token (after user login) to be used by any downstream *DBQuery* actor that needs it.

Other Execution Environments: Supporting foreign language interfaces via the Java Native Interface (JNI) gives the user flexibility to reuse existing analysis components and to target appropriate computational tools. For example, Kepler (through Ptolemy) already includes a Matlab actor. Actors that execute R code (*RExpression*, *Correlation*, *RMean*, *RMedian*, and others) are also included in the standard actor library. Any application that

³ Ibid.

can be executed on the command line can also be executed by the Kepler *CommandLineExec* actor.

Data Transformation: Kepler includes a suite of data transformation actors (XSLT, XQuery, Perl, etc.) for linking semantically compatible but syntactically incompatible Web services together.

Flexible Execution: The *BrowserUI* actor is used for injecting user control and input, as well as output of legacy applications anywhere in a workflow via the user's Web browser. Kepler workflows can also be run in batch mode using Ptolemy's background execution feature.

Configurable Libraries: Users can configure their own actor libraries via a semantic type interface, or download (and upload) additional actors from the Kepler repository. Actors can be created and added to the local library by semantically annotating them, using a *Seman*

1.1.2 Architecture

Kepler builds upon the mature [Ptolemy II framework](#), developed at the University of California, Berkeley. Ptolemy II is a software framework developed as part of the [Ptolemy project](#), which studies modeling, simulation, and design of concurrent, real-time, embedded systems. Kepler 2.0 is based on Ptolemy II 8.0.0

Kepler inherits from Ptolemy the actor-oriented modeling paradigm that separates workflow components ("actors") from the overall workflow orchestration (conducted by "directors"), making components more easily reusable. Through the actor-oriented and hierarchical modeling features built into Ptolemy, Kepler scientific workflows can operate at very different levels of granularity, from low-level "plumbing workflows" (that explicitly move data around or start and monitor remote jobs, for example) to high-level "conceptual workflows" that interlink complex, domain-specific data analysis steps. Kepler also inherits modeling and design capabilities from Ptolemy, including the Vergil graphical user interface and workflow scheduling and execution capabilities.

Kepler extensions to Ptolemy include an ever increasing number of components (called "actors") aimed particularly at scientific applications: remote data and metadata access, data transformations, data analysis, interfacing with legacy applications, Web service invocation and deployment, and provenance tracking, among others. Target application areas include bioinformatics, computational chemistry, ecoinformatics, and geoinformatics.

Ptolemy/Vergil (A Very Brief Overview)

Ptolemy II, developed at the University of California, Berkeley, is an open-source software framework developed as part of the Ptolemy project. Ptolemy II is a Java-based component assembly framework with a graphical user interface called Vergil.

The Ptolemy project studies modeling, simulation, and design of concurrent, real-time, embedded systems. The focus is on *embedded systems*, particularly those that mix technologies including, for example, analog and digital electronics, hardware and software, and electronics and mechanical devices. The focus is also on systems that are complex in the sense that they mix widely different operations, such as networking, signal processing, feedback control, mode changes, sequential decision making, and user interfaces.⁴

Ptolemy II takes a component view of design, in that models are constructed as a set of interacting components. A model of computation governs the semantics of the interaction, and thus imposes a discipline on the interaction of components.⁵

Ptolemy II offers a unified infrastructure for implementations of a number of models of computation. The overall architecture consists of a set of packages that provide generic support for all models of computation and a set of packages that provide more specialized support for particular models of computation. Examples of the former include packages that contain math libraries, graph algorithms, an interpreted expression language, signal plotters, and interfaces to media capabilities such as audio. Examples of the latter include packages that support clustered graph representations of models, packages that support executable models, and *domains*, which are packages that implement a particular model of computation.⁶

The Vergil GUI is a visual editor written in Java. Using Vergil, users can graphically construct and run scientific workflows. For more information about Vergil, see the [Ptolemy documentation](#).

Modeling Markup Language (MoML)

Modeling Markup Language (MoML), the primary persistent file format for Ptolemy II models, is an Extensible Markup Language (XML) schema. It is intended for specifying interconnections of parameterized components, and is the primary mechanism for constructing models whose definition and execution is distributed over the network.⁷

⁴ Hylands, Christopher, Edward Lee, Jie Liu, Xiaojun Liu, Stephen Neuendorffer, Yuhong Xiong, Yang Zhao, Haiyang Zheng, Ptolemy Overview, <http://www.ptolemy.eecs.berkeley.edu/publications/papers/03/overview/overview03.pdf>

⁵ Ibid.

⁶ Ibid.

⁷ Ptolemy User Manual, <http://www.eecs.berkeley.edu/Pubs/TechRpts/2007/EECS-2007-7.pdf>

The key features of MoML include:⁸

- *Web integration.* MoML is an XML schema intended for use on the Internet. File references are via URIs (in practice, URLs), both relative and absolute, so MoML is equally comfortable working in applets and applications.
- *Implementation independence.* MoML is designed to work with a variety of modeling tools.
- *Extensibility.* Components can be parameterized in two ways. First, they can have named properties with string values. Second, they can be associated with an external configuration file that can be in any format understood by the component. Typically, the configuration will be in some other XML schema, such as PlotML or SVG (scalable vector graphics).
- *Classes and inheritance.* Components can be defined in MoML as classes which can then be instantiated in a model. Components can extend other components through an object-oriented inheritance mechanism.
- *Semantics independence.* MoML defines no semantics for an interconnection of components. It represents only the hierarchical containment relationships between entities with properties, their ports, and the connections between their ports. In Ptolemy II, the meaning of a connection (the semantics of the model) is defined by the director for the model, which is a property of the top level entity. The director defines the semantics of the interconnection. MoML knows nothing about directors except that they are instances of classes that can be loaded by the class loader and assigned as properties.

For detailed information about MOML and its syntax, please see the [Ptolemy user manual, Chapter 7](#).

1.2 History of the Kepler Project

Kepler was founded in 2002 by researchers at the [National Center for Ecological Analysis and Synthesis \(NCEAS\)](#) at University of California Santa Barbara, the [San Diego Supercomputer Center \(SDSC\)](#) at University of California San Diego, and the [University of California Davis](#) as part of the Science Environment for Ecological Knowledge ([SEEK](#)) and Scientific Data Management ([SDM](#)) projects. The Kepler software extends the [Ptolemy II](#) system developed by researchers at the University of California Berkeley. Although not originally intended for scientific workflows, Ptolemy II provides a mature platform for building and executing workflows, and supports multiple models of computation.

⁸ Ibid.

An alpha version of the Kepler software was released in April of 2005. Three beta versions followed: beta1, June 2006; beta2, July 2006; and beta3, January 2007. The first official release, Version 1, was released on May 2, 2008. Version 2.0.0 was released in June 2010 with major improvements to the GUI, modular design and KAR handling.

Kepler is an open collaboration with many contributors from diverse domains of science and engineering, including ecology, evolutionary biology, molecular biology, geology, chemistry, computer science, electrical engineering, oceanography, and others. Members from the following projects are currently contributing to the Kepler project:

- [SEEK: Science Environment for Ecological Knowledge](#)
- [SDM Center/SPA: SDM Center/Scientific Process Automation](#)
- [Ptolemy II: Heterogeneous Modeling and Design](#)
- [GEON: Cyberinfrastructure for the Geosciences](#)
- [ROADNet: Real-time Observatories, Applications, and Data Management Network](#)
- [EOL: Encyclopedia of Life](#)
- [Resurgence](#)
- [CIPRes: CyberInfrastructure for Phylogenetic Research](#)
- [REAP: Realtime Environment for Analytical Processing](#)
- [Kepler/CORE: Development of a Comprehensive, Open, Reliable, and Extensible Scientific Workflow Infrastructure](#)

Contributing members jointly determine the goals for Kepler as well as contribute to the design and implementation of the software system. We welcome contributions and encourage other people and projects to join as contributing members. For more information about contributing to Kepler, please see Section 1.5.

Some Kepler members receive support from various grants, including but not limited to: the National Science Foundation under awards 0225676 for SEEK, 0225673 (AWSFL008-DS3) for GEON, 0619060 for REAP, and 0722079 for Kepler/CORE; by the Department of Energy under Contract No. DE-FC02-01ER25486 for SciDAC/SDM; and by DARPA under Contract No. F33615-00-C-1703 for Ptolemy.

Work was conducted with logistical support from the National Center for Ecological Analysis and Synthesis, a Center funded by NSF (Grant #DEB-0553768), the University of California, Santa Barbara, and the State of California.

Ptolemy receives support in part from the Center for Hybrid and Embedded Software Systems (CHESS) at UC Berkeley, which receives support from the National Science Foundation (NSF award #CCR-0225610), the State of California Micro Program, and the following companies: Agilent, DGIST, General Motors, Hewlett Packard, Infineon, Microsoft, and Toyota.

1.3 Kepler Code Contributors

The following people have made contributions to the Kepler code. Contributors are listed in chronological order of commits to the SVN repository:

Matthew Jones
Chad Berkley
Ilkay Altintas
Zhengang Cheng
Efrat Frank
Bertram Ludaescher
Jing Tao
Steve Mock
Xiaowen Xin
Dan Higgins
Yang Zhao
Christopher Brooks
Tobin Fricke
Rod Spears
Werner Krebs
Shawn Bowers
Laura Downey
Wibke Sudholt
Timothy McPhillips
Bing Zhu
Nandita Mangal
Jagan Kommineni
Jenny Wang
John Harris
Kevin Ruland
Matthew Brooke
Oscar Barney
Vitaliy Zavesov
Zhije Guan
Norbert Podhorszki
Samantha Katz
Tristan King
Josh Madin
Kirsten Menger-Anderson
Edward Lee
Daniel Crawl
Derik Barseghian
Lucas Gilbert
Nathan Potter

Ben Leinfelder
Carlos Rueda
Jim Regetz
Sean Riddle
Aaron Schultz
David Welker
Mark Schildhauer
Debi Staggs
Jianwu Wang
Sven Koehler
Faraaz Sareshwala
Daniel Zinn
Madhusudan
Chandrika Sivaramakrishnan
Lei Dou
Merve Ildeniz

Contributions to Kepler are welcome. Please see Section 1.5 for details on how to contribute. Thanks.

1.4 Future Goals

The Kepler project is an ongoing collaboration, and we will continue to refine, release, and support the Kepler software. Our aim is to improve and enhance the Kepler scientific workflow system to yield a comprehensive, open, reliable, and extensible scientific workflow infrastructure suitable for serving a wide variety of scientific communities.

The goal of future Kepler development is to (i) enable multiple groups in a number of distinct disciplines to easily create, support, and make available domain-specific Kepler extensions; (ii) better support those crucial features that are needed by all disciplines; and (iii) provide for the wide range of deployment scenarios required by different disciplines and distinct research settings.

More specifically, future goals include making Kepler:

Independently Extensible. Rather than enforcing conventions that might slow progress in the various disciplines contributing to Kepler, we plan to further enable independent extensibility of Kepler while making it easy to package domain-specific contributions in a way that ensures both the stability of the overall system and clearly indicates what components are expected to work well together.

With the 2.0 release of Kepler, we have created a module system that allows us to separate Kepler base system functionality from domain-specific extensions. We have divided Kepler into a set of mandatory modules (the kepler suite); a set of extension modules that communicate with the kernel via well-defined and generic extension

interfaces; and a number of actor modules for distinct disciplines. We developed a configuration management system to support downloading, installing, and updating the Kepler distribution and a Module Manager for discovering and installing standard and 3rd-party modules and specifying modules to be employed during execution. With this architecture, third-parties can now develop alternative modules with additional capabilities suitable for particular science domains.

Consistently Reliable: Reliability for developers and users alike ensures that Kepler can be applied confidently as dependable cyberinfrastructure. We are working to ensure run-time reliability (both for when Kepler is used as a desktop research application and as middleware that other domain-specific applications can build upon). Our approach of dividing Kepler into the Kepler kernel and extension set will enable other development teams to freely develop new modules and actor packages as needed without endangering the stability of the kernel, and even to replace standard extensions as needed.

Open Architecture, Open Project. We will disseminate plans, designs, and system documentation as we develop them and provide mechanisms for suggestions and feedback throughout the course of the project. We will also actively engage the user community and gather requirements, advice, and feedback on priorities, both from those already committed to using Kepler (i.e., the Kepler “stakeholders”), and from scientists who could benefit.

Comprehensive (End-to-End) System. We plan to widen the scope of Kepler by providing new, fundamental enhancements that will benefit all user communities: enhancing Kepler with new and improved generic capabilities for data, service, and workflow management. More specifically, we are working on new and more comprehensive systems for:

- **Data Management.** We plan to support data management tasks in a generic way within the Kepler framework so that all data management tasks (e.g., controlling and managing the flow of data into and out of workflows, comparing and visualizing data and metadata, converting data formats, and managing data references) are handled transparently by the workflow execution framework rather than by special-purpose actors.
- **External Service and Grid Management.** Currently, Kepler workflows that make extensive use of external services generally use actor-oriented approaches for managing and accessing those services. We are working to better enable the system to carry out computations on the optimal set of computing resources at run time, based on resource availability and preferences; and to make it easier for users to share and redeploy workflows in different environments. In addition, we are working on integrated support for managing authentication and authorization information.
- **Workflow Management.** Our goal is for Kepler to provide comprehensive support for end-to-end workflow management—from initial prototyping to workflow execution. We are working to make the application aware of the scientific context

in which workflows are being run, the flow of data through and across successive workflows (as is common in scientific research), and the origin of workflows. In addition, we will continue to improve support for common workflow management tasks such as designing, storing, and validating individual workflows; organizing workflows, data, and results within the context of a particular project or research study; and capturing and querying the provenance of workflows and data. The Kepler workflow-run-manager and provenance modules will provide a whole new suite of functionality for managing workflows.

Please see the [Kepler/CORE Web page](#) for detailed information about specific features that are under development, and/or the [Bug base](#) for more features that we are adding and improving in the coming months.

1.5 Participating in Kepler Development

Kepler is an open source cross-project collaboration, and we welcome contributions of all types. Participants can get involved by joining a mailing list (either for developers or users), participating in IRC chat, or getting a Kepler SVN account to view or contribute to the Kepler source.

Individuals can join the [kepler-dev](#) mailing list to interact with the rest of the development team or the [kepler-users](#) mailing list to request and/or exchange user support. The current list of subscribers is available only to list members and can be viewed (after subscription) at the mailing list info page.

Many of the Kepler developers use IRC to chat on a daily basis. We use the '#kepler' channel on [irc.ecoinformatics.org:6667](irc://irc.ecoinformatics.org:6667) for our discussions. More details on how to use IRC can be found on the [SEEK IRC page](#).

The code for Kepler is managed in an SVN repository. Read-only access is open for all. If you need to write to the SVN repository, please visit <https://kepler-project.org/developers> for instructions. You can use any [SVN client](#) to access the Kepler repository.

To check out and build the Kepler source code, you will need to be running Java 1.5 or later, Ant 1.7.1, and have installed an SVN client, v1.5. For development with Eclipse these have been tested with Eclipse Ganymede and SVN 1.5.5, with Subclipse 1.4.7.

Downloading the Build

To download the latest version of the build from the repository, you will want to create a new directory and then execute the svn checkout (co) command as in the following example.

```
mkdir <modules.dir>
cd <modules.dir>
svn co https://code.kepler-project.org/kepler/trunk/modules/build-area
cd build-area
```

<modules.dir> is the name of the directory where the build will be stored, as well as the modules you will be working on. A good name for this folder might be something like kepler.modules.

Retrieving Kepler and Ptolemy

Now that the build system is downloaded you will use the build system to retrieve Kepler and Ptolemy.

First, you need to decide whether you would like to work with the latest version of Kepler (referred to as the “trunk” of Kepler), or whether you would like to work with the 2.0.0 version of Kepler that was released in February 2010.

To work from the trunk, issue the following command:

```
ant change-to -Dsuite=kepler
```

To retrieve Kepler version 2.0:

```
ant change-to -Dsuite=kepler-2.0
```

Some explanation of what the “ant change-to command is doing:

What is actually first retrieved is something known as a **suite**. This suite contains information on where to retrieve the desired versions of Kepler and Ptolemy and that information is used by the system to then retrieve the appropriate versions of Kepler and Ptolemy. By default, when you type **ant get -Dsuite=kepler**, you are making a request for a particular suite named kepler, which has information on how to download Kepler and Ptolemy.

A final note, when you do **get -Dsuite=<suite.name>** you retrieve not only the suite, but all the modules that are associated with the suite as well. If you want to retrieve a single module instead of a suite of modules, you just type **ant get -Dmodule=<module.name>** instead.

Note:

If you are behind a firewall and do not have access to port 22 and you are working off the trunk, then the download of ptolemy will fail when you execute the "ant change-to -Dsuite=kepler" command. In this case, you must download ptolemy manually using the following command:

```
svn co https://source.eecs.berkeley.edu/svn/chess/ptII/trunk <kepler.modules>/ptolemy
```

Running Kepler

Now that you have downloaded the Kepler Build System and have used it to retrieve the Kepler version that interests you, you are ready to run. Just type:

```
ant run
```

Note that it would be possible for a new user to get started without having to enter a command between get and run by chaining these commands in ant. So, for example, if you wanted to download and run Kepler from the trunk all in one command, you could type:

```
ant change-to -Dmodule=kepler run
```

Using Eclipse

See [Kepler and Eclipse](#) for more detailed instructions. However, in most cases, these instructions should be adequate.

1. Type **ant eclipse**.
2. Open Eclipse in a new or existing workspace.
3. Choose **File->Import...** Under the **General** folder, choose **Existing Projects into Workspace**. Click **Next**.
4. Click **Browse** right next to the **Select root directory:** field. Go to and select the <module.dir> directory where you saved the build and downloaded your modules. Click **Choose**.
5. The projects that were generated will be automatically detected by Eclipse. Click on **Finish**.
6. KarDoclet.java uses doclet code from tools.jar. If you are using Java 1.6, you will need to add tools.jar to the list of external jars:
Windows -> Preferences -> Java -> Installed JREs
Select the default JRE -> Edit -> Add External Jars -> [Path to JDK]/lib/tools.jar

If you have the [Subversive](#) Eclipse plugin installed you can select the newly generated projects, right click on them and choose "Share Projects" and follow the instructions in the wizard to set up the connection to the [Kepler repository](https://code.kepler-project.org/code/kepler/) (https://code.kepler-project.org/code/kepler/). Repeat the process for the ptolemy project using the [Ptolemy repository](svn://source.eecs.berkeley.edu/chess/ptII/) (svn://source.eecs.berkeley.edu/chess/ptII/).

If you have the Subversive plugin installed, see [Updating the local copy of the Kepler sources](#)

To run kepler, create a new Java Application Run Configuration: with project: loader, Main class: org.kepler.Kepler

These instructions and further reference detail, including how to run a workflow from the command line, and setting system properties, and other details can be found at: [Kepler Build System Instructions and Overview](#).

Contributing to Kepler

In order to contribute directly to Kepler, one must use a named account to enable you to make changes to the web site or the SVN repositories. In general, people with write access should only make changes to modules with which they are directly involved or that they have discussed with the relevant Infrastructure and Development Teams. Please be sure you have contacted the appropriate Team(s) before you request an account.

To request a named account, send an email to pmc@ecoinformatics.org with your name, association and a brief description of your project needs.

1.6 Reporting Bugs

The Kepler project uses [Bugzilla](#) for reporting bugs as well as for sharing future development plans. Please register yourself by [creating a new bugzilla account](#) to participate in future plans, bug reports, and updates. Note that you need to have an ecoinformatics.org account to be able to register.

Bugzilla is one example of a class of programs called "Defect Tracking Systems", or, more commonly, "Bug-Tracking Systems". Defect Tracking Systems allow individual or groups of developers to keep track of outstanding bugs in their product effectively.

1.7 Further Reading

As part of the outreach effort for Kepler, we have produced a variety of documents and publications. Publications of interest include:

- [Scientific Workflow Management and the Kepler System](#), B. Ludäscher, I. Altintas, C. Berkley, D. Higgins, E. Jaeger-Frank, M. Jones, E. Lee, J. Tao, Y. Zhao, *Concurrency and Computation: Practice & Experience*, 18(10), pp. 1039-1065, 2006.

Additional publications are listed on the Kepler web site at <http://kepler-project.org>.

Independent publications of the collaborating projects can be reached at their main websites: [SEEK](#), [SDMCenter-SPA](#), [KBIS-SPA](#), [Ptolemy](#), and [GEON](#).

2. Installing and Running Kepler

2.1 System Requirements

Recommended system requirements for Kepler:

- 300 MB of disk space
- 512 MB of RAM minimum, 1 GB or more recommended
- 2 GHz CPU minimum
- Java 1.5.x
- Network connection (optional). Although a connection is not required to run Kepler, many workflows require a connection to access networked resources.
- R software (optional). R is a language and environment for statistical computing and graphics, and it is required for some common Kepler functionality.

Java 1.5.x is required and can be obtained from Sun's Java website at: http://java.sun.com/javase/downloads/index_jdk5.jsp or from your system administrator. Some Kepler installations include Java 1.5 and others do not. Check the installation instructions for your platform for more information.

2.2 Installing Kepler

Kepler is an open-source, cross-platform software program that can run on Windows, Macintosh, or Linux-based platforms. Instructions for each platform are contained in the following sections. Before installing a new version of Kepler we recommend that you uninstall any prior versions.

2.2.1 Installing on Windows

The Windows installer will install the Kepler application and (optionally) R--a statistical computing language and environment used by a number of Kepler actors--on your system.

If R is installed with Kepler, it should not interfere with a previously installed version of R except when one launches R from the command line (by entering 'R'). The Kepler installer updates your system so that the new version of R will be launched from the command line. Existing shortcuts will still open the previously installed R application. The version of R included with the Kepler installer is 2.9.0.

Follow these steps to download and install Kepler for Windows:

1. Click the following link: <https://kepler-project.org/users/downloads> and select the Windows installer.
2. Save the install file to your computer.
3. Double-click the install file to open the install wizard (*Figure 2.1*). We recommend that you quit all programs before continuing with the installation. You can cancel the installation at any point via the Quit button in the lower right corner of the installer. To proceed with the installation, click the Next button.
4. Click the Next button. An information screen containing notes about the application appears. Click Next once you have read through the information to select an installation path. By default, the software will be installed in C:\Program Files\Kepler. The installer will create the target directory if it does not yet exist. If the directory already exists, the installer will confirm the location before possibly overwriting an existing version.
5. Choose the packs to install: The available choices include Kepler, Workflow Demos, Outreach Material, the R Kepler Module, R 2.9.0 for Windows, and Ptolemy II. All packs are required, except or the Workflow Demos and R 2.9.0. If you are unsure, you should install everything. The Workflow Demos are a set of demos that demonstrate how to compose a workflow and example functionality. R is a language and environment for statistical computing and graphics, and it is required for some common Kepler functionality. For more information about R, see <http://www.r-project.org>. Once you have selected an installation, click the Next button.
6. The Kepler installer displays a status bar as the installation progresses. If Kepler has previously been installed on the system, the installer will overwrite any existing cache files.

Once the installation is complete, a confirmation screen opens. An uninstaller program is also created in the installation location. Restart the computer to complete the installation. A Kepler shortcut icon will appear on your desktop.



2.2.3 Installing on Macintosh

The Mac installer will install the Kepler application and (optionally) R--a statistical computing language and environment used by a number of Kepler actors--on your system. Java is included as part of the Mac OSX operating system, so it need not be installed.

Because [R](#) is required for some common Kepler functionality, we recommend that users choose to install R with the Kepler installation (the default). If R is installed with Kepler, it should not interfere with a previously installed version of R except when one launches R from the command line (by entering 'R'). The Kepler installer updates your system so that the new version of R will be launched from the command line. Existing shortcuts will still open the previously installed R application. The version of R included with the Kepler installer is 2.9.0.

Follow these steps to download and install Kepler for Macintosh systems:

- 1 Click the following link: <https://kepler-project.org/users/downloads> and select the Mac install file. Save the install file to your computer.
- 2 Double-click the install icon that appears on your desktop when the extraction is complete.
- 3 Follow the steps presented in the install wizard to complete the Kepler installation process.

A Kepler icon is created under /Applications/Kepler-2.0. The icon can be dragged and dropped to the desktop or the dock if desired.

2.2.4 Installing on Linux

The Linux installer will install the Kepler application. If you do not have Java 1.5.x installed, it will direct you to a page to download and install it. Java 1.5.x is required in order to run the Kepler software. R, a language and environment for statistical computing and graphics, is *NOT* included with the Linux installer. Because R is required for some common Kepler functionality, we recommend that users download and install R. For more information about R, see <http://www.r-project.org>.

Follow these steps to download and install Kepler for Linux:

1. Click the following link: <https://kepler-project.org/users/downloads> and select the Linux install file.
2. Save the install file to your computer

3. Double-click the install file to open the install wizard. If double-clicking the install file doesn't work on your system, you may run the command `java -jar installer-file-name` in a terminal to open the install wizard. We recommend that you quit all programs before continuing with the installation.
4. The Kepler installer displays a status bar as the installation progresses. If Kepler has previously been installed on the system, the installer will overwrite any existing cache files.

2.3 Starting Kepler

To start Kepler on a PC, double-click the Kepler shortcut icon on the desktop. Kepler can also be started from the Start menu. Navigate to Start menu > All Programs, and select "Kepler" to start the application. On a Mac, the Kepler icon is created under Applications/Kepler. The icon can be dragged and dropped to the desktop or the dock if desired.

To start Kepler on a Linux machine, use the following steps:

1. Open a shell window. On some Linux systems, a shell can be opened by right-clicking anywhere on the desktop and selecting "Open Terminal". Speak to your system administrator if you need information about your system.
2. Navigate to the directory in which Kepler is installed. To change the directory, use the `cd` command (e.g., `cd directory_name`).
3. Type `./kepler.sh` to run the application.

The main Kepler application window opens (*Figure 2.3*). From this window you can access and run existing scientific workflows and/or create your own custom scientific workflow. Each time you open an existing workflow or create a new workflow, a new application window opens. Multiple windows allow you to work on several workflows simultaneously and compare, copy, and paste components between workflows.

To start Kepler from the command line (optionally loading a workflow), use the following command:

```
kepler [workflow.xml]
```

To run a workflow from the command line--with or without the Graphical User Interface (GUI)--use the following command:

```
kepler -runwf [-gui|-nogui] [-cache|-nocache] workflow.xml
```

<code>-gui</code>	run with GUI support (default).
<code>-nogui</code>	run without GUI support.
<code>-cache</code>	run with kepler cache (default).
<code>-nocache</code>	run without kepler cache.

Running a workflow without the GUI is useful in environments with no graphic support, such as from a web portal.

Additionally, you can specify the values of workflow parameters:

```
kepler -runwf workflow.xml -x 4 -y "foo"
```

The above command runs 'workflow.xml', setting the parameters $x = 4$ and $y = \text{"foo"}$.

2.4 The User Interface

Scientific workflows are edited and built in Kepler's easily navigated, drag-and-drop interface. The major sections of the Kepler application window (*Figure 2.2*) consist of the following:

- Menu bar – provides access to all Kepler functions.
- Toolbar – provides access to the most commonly used Kepler functions.
- Components, Data Access, and Outline area – consists of a Components tab, a Data tab, and an Outline tab. The Components tab, and the Data tab both contain a search function and display the library of available components and/or search results. The Outline tab displays an outline of components that are in your current workflow.
- Workflow canvas – provides space for displaying and creating workflows.
- Navigation area – displays the full workflow. Click a section of the workflow displayed in the Navigation area to select and display that section on the Workflow canvas.

Each of these interface areas is described in more detail in the following sections.

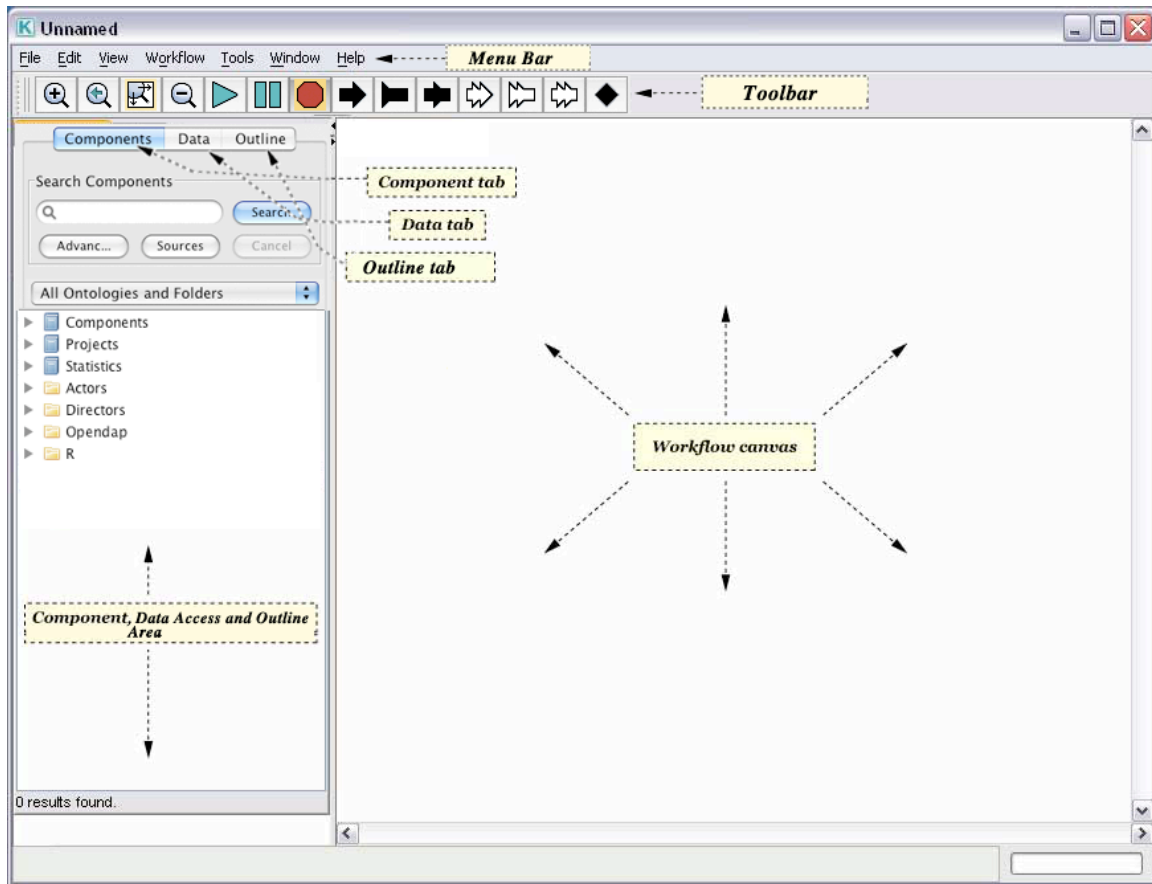

Figure 2.1: Empty Kepler window with major sections annotated.

2.4.1 Menu Bar

Running horizontally across the top of the Kepler application, the Menu bar contains the seven Kepler menus: File, Edit, View, Workflow, Tools, Window, and Help. Common menu item functions, such as Copy, Paste and Delete, are assigned keyboard shortcuts, which can also be used to access the functionality. These shortcuts, when relevant, appear to the right of each menu item.

The following sections describe each menu in greater detail.

2.4.1.1 File Menu

The File menu, which is the first menu in the Menu bar, contains commands for handling files and for exiting the application: New Workflow, Open, Open MoML, Open MoML URL, Close, Save, Save As, Export, Print, and Exit.

New Workflow: open a new application window. Select Blank, FSM, or Modal Model. For more information about FSM and Modal Models, please see the [Ptolemy documentation](#).

Open...: open a workflow saved in a KAR. KARs (Kepler Archive format) are JARs, and are used by Kepler to aggregate workflows and other related files.

Open MoML: open an existing workflow saved as xml (with file extensions .xml or .moml) onto the Workflow canvas. Text-based files—text (.txt) or html (.html), for example—will be opened in a viewing window.

Open MoML URL: open a remote Web address in a viewing window. The viewing window permits browsing; links will open in a new viewing window.

Save: save the workflow displayed on the Workflow canvas and any other related files into a KAR (Kepler Archive format) file.

Save As: save the current workflow to a new KAR.

Export: save the current workflow as MOML (MOdeling Markup Language) XML.

Print: print the graphical representation of the workflow. A page setup window is used to set the paper size, source, margins, and orientation.

Close: close the current Workflow canvas.

Exit: exit the Kepler application. If a workflow is open, a dialog box will prompt a user to save or discard changes. Users can also cancel and return to the main application window.

2.4.1.2 Edit Menu

Edit menu items are primarily used to modify the Workflow canvas, allowing users to cut, copy, and paste selected entities. In addition, Undo and Redo commands can be used to modify the history of workflow changes.

Undo: (Ctrl+Z) Undo the most recent change. The "Undo" command can be performed multiple times to undo the history of workflow changes. The size of the history buffer is limited only by available RAM.

Redo: (Ctrl+Y) Redo the most recent change. The "Redo" command can be performed multiple times to redo the history of workflow changes.

Cut: (Ctrl+X) Cut the selected entities.

Copy: (Ctrl+C) Copy the selected entities to the clipboard.

Paste: (Ctrl+V) Paste the contents of the clipboard to the Workflow canvas.

Delete: (Ctrl+X or Delete key) Delete the selected entities.

2.4.1.3 View Menu

View menu items control how the workflow appears on the Workflow canvas. Zoom items are also available via the Toolbar.

Zoom Reset (Ctrl+Equals): Reset the view of the Workflow canvas to the default settings.

Zoom In (Ctrl+Shift+Equals): Magnify the Workflow canvas for a more close-up view. Kepler provides fixed levels of zoom.

Zoom Out (Ctrl+Minus): Pull back for a more distant view of the Workflow canvas. Kepler provides fixed levels of zoom.

Zoom Fit (Ctrl+Shift+Minus): Display the current workflow in its entirety on the Workflow canvas.

Automate Layout (Ctrl+T): Make a workflow more readable by automatically configuring actor locations. This option is usually most useful if actors have been placed on top of each other.

XML View: View the current workflow in XML mode. The workflow MoML XML will be displayed in a viewing window.

2.4.1.4 Workflow

Workflow menu items are used to run and modify open workflows.

Runtime Window: The Runtime Window command opens a Run window, which allows users to adjust workflow parameters and run, pause, resume, or stop workflow execution. Workflow results are displayed in the window as well.

Add Relation: Add a Relation to the Workflow canvas. Relations, which might also be called 'connectors,' allow actors to "branch" output to multiple places. For more information about Relations, see Section 3.2.7.

Add Port: Add a port to the Workflow canvas. Select Input, Output, Input/Output, Input Multiport, Output Multiport, or Input/Output Multiport. For more information about ports, see Section 3.2.4.

2.4.1.5 Tools

The Tools menu contains a number of useful tools that are used to build and troubleshoot workflows.

Animate at Runtime: Select this menu item to highlight the actor that is currently processing as the workflow is run. The active actors will be denoted with a red highlight. Note: This command is only relevant when an SDF Director is used.

Listen to Director: Open a viewing window that displays the Director's activity, noting when each actor is preinitialized, initialized, prefired, iterated, and wrapped up.

Create Composite Actor: Create a new composite actor on the Workflow canvas. For more information about composite actors, please see Section 3.2.3.

Expression Evaluator: Open an Expression Evaluation window used to evaluate any Kepler expression. For more information about the expression language, see the [Ptolemy documentation](#).

Instantiate Component: Open the designated component on the Workflow canvas. Components can be identified via class name (e.g., `ptolemy.actor.lib.Ramp`) or via a URL. Use this menu command to easily access components that are not included in the Kepler component tree (e.g., the DDF Director or Ptolemy actors that are not included in the default Kepler library).

Instantiate Attribute: Open the designated attribute on the Workflow canvas. Attributes are identified by class name (e.g., `ptolemy.vergil.kernel.attributes.EllipseAttribute`).

Check System Settings: Open a window containing system settings.

Ecogrid Authentication: Provide log in credentials or log out after using features in Kepler that require authentication (e.g., an authenticated data search for the KNB (Earthgrid) or uploading actors to the Kepler actor library).

Preferences: Set various Kepler preferences, including local and remote directories used to find components for the component library and services used for data sources.

Text Editor: Open a simple text editor used to create, edit, and save text files.

Module Manager: View modules in the current suite, load and save module configurations, view downloaded modules, and view available modules, and switch to a

different module configuration. For more information on the module manager, see Chapter 12.

2.4.1.6 Window

Access the Runtime Window via the menu option.

2.4.1.7 Help

The Help menu contains information about the current version of Kepler as well as links to useful help documentation.

About: Open a window containing the current Kepler version number.

Kepler Documentation: An index of useful Kepler documents.

Modules Documentation: An index of documentation for the installed modules.

2.4.2 Toolbar

The Kepler Toolbar contains the most commonly used Kepler functions (*Figure 2.2*). The Toolbar can be dragged and dropped to a convenient screen location. Closing the Toolbar returns it to the default position beneath the Menu bar and above the Workflow canvas.

The Toolbar consists of three main sections: View, Run, and Ports, discussed in more detail below.

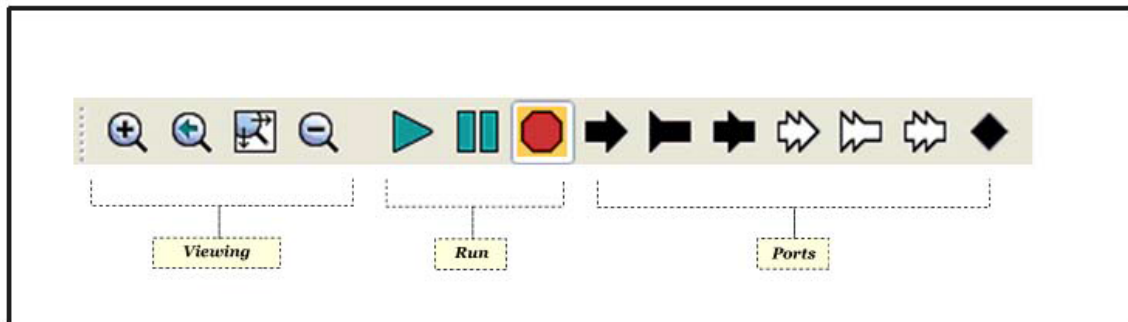

Figure 2.2: The Kepler Toolbar.

2.4.2.1 View Tools

View tools (*Table 2.1*) are used to zoom in, reset, fit, and zoom out of the workflow on the Workflow canvas:





	Zoom In: Magnify the Workflow canvas for a more close-up view. Kepler provides fixed levels of zoom.
	Zoom Reset: Reset the view of the Workflow canvas to the default settings.
	Zoom Fit: Display the current workflow in its entirety on the Workflow canvas.
	Zoom Out: Pull back for a more distant view of the Workflow canvas. Kepler provides fixed levels of zoom.

Table 2.1 View tools

2.4.2.2 Run Tools

Run tools (*Table 2.2*) are used to run, pause, and stop the workflow.



	Run: Run the workflow. The button will have an orange highlight when the workflow is running.
	Pause: Pause the workflow. The button will have an orange highlight when the workflow is paused. To resume the workflow, click the Run button.
	Stop: Stops workflow execution. The button will have an orange highlight when the workflow is stopped. To restart the workflow, click the Run button.

Table 2.2: Run tools

2.4.2.3 Port Tools

Port tools (*Table 2.3*) are used to add Relations or Ports to workflows:







	Input Port: Add a single input port. A single input port can be connected to only a single channel of data. Single ports are designated with a dark triangle on the Workflow canvas.
	Output Port: Add a single output port. A single output port can emit only a single channel of data. Single ports are designated with a dark triangle on the Workflow canvas.
	Input/Output Port: Add a bi-directional port, which can receive or send a single channel of data.
	Multiple Input Port: Add a multiple input port. A multiple input port can be connected to multiple channels of data. Multiple ports are designated with a hollow triangle on the Workflow canvas.
	Multiple Output Port: Add a multiple output port. A multiple output port can emit multiple channels of data. Multiple ports are designated with a hollow triangle on the Workflow canvas.
	Multiple Input/Output Port: Add a multiple input/output port. A multiple input/output port can receive or send multiple channels of data. Multiple ports are designated with a hollow triangle on the Workflow canvas.
	Relation: Add a Relation. Relations “branch” a data flow so that data can be sent to multiple places in the workflow.

Table 2.3: Port tools

2.4.3 Components, Data Access, and Outline Areas

The Components and Data Access area contains a library of workflow components (e.g., directors and actors, under the Components tab) and a search mechanism for locating those components, as well as data sets (under the Data tab). The Outline area displays an outline tree of the components that are being used in the current workflow. When the application is first opened, the Components tab is displayed.

2.4.3.1 Components Tab

Kepler comes standard with over 350 components that are stored on the local machine and can be used to create an innumerable number of workflows with a variety of analytic functions. The default set of Kepler processing components is displayed under the Components tab in the Components and Data Access area. Users can easily add new components or modify existing components as well. See Chapter 5 for more information about adding components to the local library.

Components in Kepler are arranged in three high-level categorizations: Components, Projects, and Statistics (*Table 2.4*). Any given component can be classified in multiple categories, appearing in multiple places in the component tree.

Category	Description
Components	Contains a standard library of all components, arranged by function.
Projects	Contains a library of project-specific components (e.g., SEEK or CIPRes)
Statistics	Contains a library of components for use with statistical analysis.

Table 2.4: Component Categories in Kepler

Browse for components by clicking through the component trees, or use the search function at the top of the Components tab to find a specific component.

To search for components:

1. In the Components and Data Access area to the left of the Workflow canvas, select the Components tab.
2. Type in the desired search string (e.g., “File Fetcher”).
3. Click the Search button. When the search is complete, the search results are displayed in the Components and Data Access area. The search results replace the default list of components. You may notice multiple instances of the same component. Because components are arranged by category, the same component may appear in multiple places in the search results.
4. To use one or more components in a workflow, simply drag the desired components to the Workflow canvas.
5. To clear the search results and re-display the complete component library, click the Reset button.

NOTE: If you know the name of a component and its location in the Component library, you can navigate to it directly, and then drag it to the Workflow canvas.

2.4.3.2 Data Tab

Via its search capabilities, Kepler provides access to data stored remotely on the EarthGrid, which contains a wide collection of ecological and geographical resources. Select the Data Tab (*Figure 2.3*) in the Components and Data Access area to find and retrieve remote data sets.

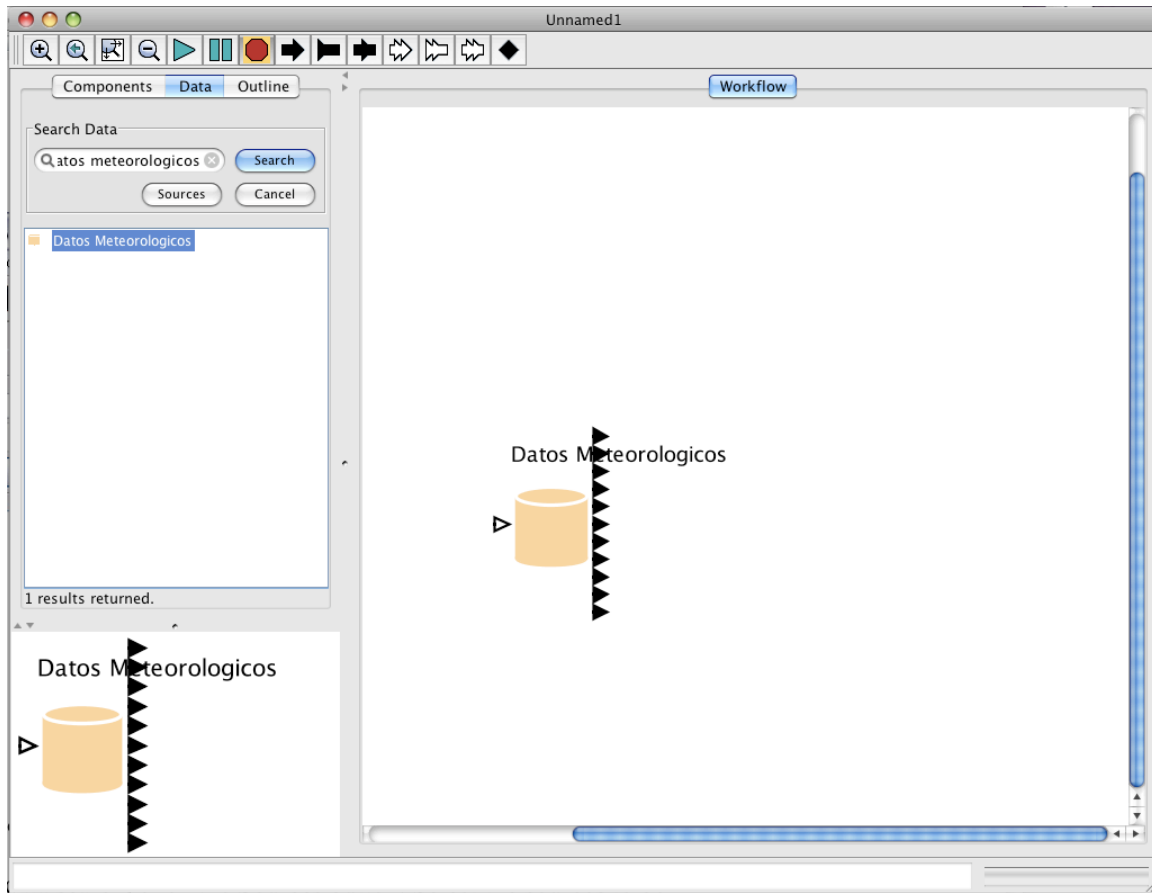

Figure 2.3: The Data Tab. A search has been performed to locate "Datos Meteorologicos", a data set stored on the EarthGrid.

To search for data on the EarthGrid through Kepler:

1. In the Components and Data Access area, select the Data tab.
2. Click the Sources button and select the services to search (deselecting unnecessary sources decreases search time).
3. Type in the desired search string (e.g., Datos Meteorologicos). Make sure that the search string is spelled correctly. (You can also enter just part of the entire string – e.g., 'Datos'). If the search requires authentication (e.g., searches on the KNB Authenticated Query source), use the Tools > Ecogrid Authentication menu option to specify credentials.
4. Click the Search button. The search may take several moments. When the search is complete, a list of search results (i.e., Data actors) will be displayed in the Components and Data Access area.
5. To use one or more data actors in a workflow, simply drag the desired actors to the Workflow canvas.

When a data set is dragged from the Data tab to the Workflow canvas, Kepler downloads the data from the remote source and stores it in the Kepler cache where it can be accessed by the workflow or easily previewed. The cache (i.e., the '.kepler' directory) is in the user's HOME directory, which is the default working directory whenever one first opens

a Command Window (on Windows platforms) or a terminal window (on Mac or Linux). On Mac and Linux systems, the command `'cd ~'` will change directories to the home directory. Once data is stored in the cache, Kepler will automatically access the local copy rather than re-download the data. If you would prefer to re-download the data, and you are using an *EML2Dataset* actor, select the `Check for latest version` parameter to override the default behavior. See Chapter 6 for more information.

Information about downloaded data can be revealed in three ways: (1) on the Workflow canvas, roll over the Data actor's output ports to reveal a tool tip containing the name and type of data or (2) right-click the Data actor and select `Get Metadata` to open a window that contains more information about the data set (*Figure 2.4*) or (3) preview the data set by right-clicking the data actor and selecting `Preview` from the drop-down menu (*Figure 2.6*).

Data Set Description

Identifier: tao.1.1
 Catalog System: knb
 Title: **Datos Meteorologicos**

Data Set Owner(s)
 Individual: **Mr. Rodrigo Torrens**

Access Control
 Auth System: knb
 Order: denyFirst

Access Rules
 ALLOW: [read] public

Contact
 Individual: **Mr. Rodrigo Torrens**

Data Tables, Images, and Other Entities
 Data Table:
 Name: **Datos Meteorologicos**
 Description: Dtos Estacion meteorologica La Hechicera para e? 2001

Physical Structure

Object Name: sample.dat
 Size: 188860 bytes
 Character Encoding: ASCII

Text Format

Number of Header Lines: 1
 Record Delimiter: \n
 Maximum Record Length: column
 Simple Delimited: Field Delimiter: ,

Case Sensitive? no
 Number Of Records: 100

Attribute(s) Info:

Attribute Name	Column Label	Definition	Type of Value	Measurement Type	Measurement Domain	Missing Value Code	Accuracy Report	Accuracy Assessment	Coverage Method
DATE	DATE	Date of collection	string	datetime	Format Precision: MMDDYY				

Figure 2.4: Metadata for the Datos Meteorologicos data set.

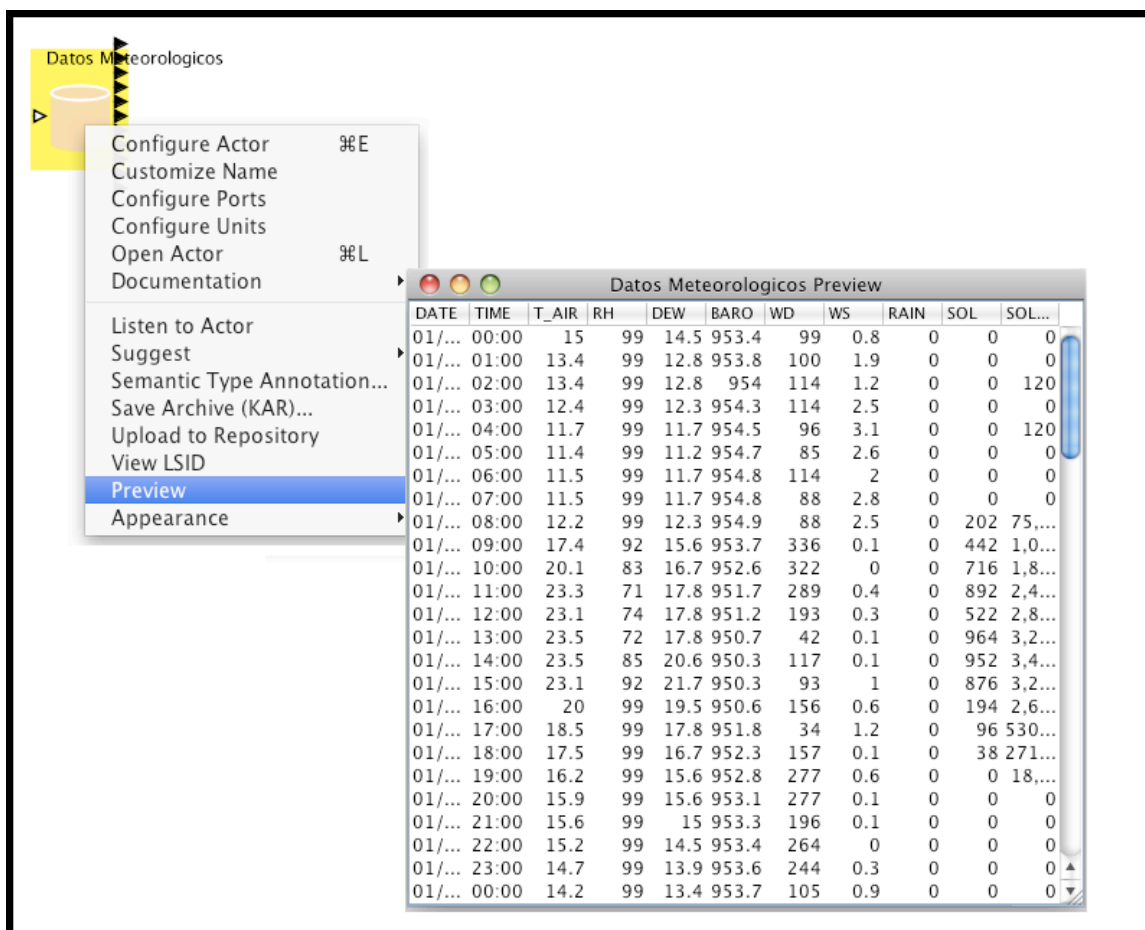

Figure 2.5: Previewing a data set.

Downloaded data can be output in a variety of formats. See Chapter 6 for more information.

The EarthGrid currently interfaces with KNB Metacat database. The Knowledge Network for Biocomplexity (KNB) is a national network intended to facilitate ecological and environmental research on biocomplexity. It enables the efficient discovery, access, interpretation, integration, and analysis of many kinds of ecological data from a highly distributed set of field stations, laboratories, research sites, and individual researchers.⁹

To configure a data search to search a subset of the EarthGrid, click the Sources button from the Data tab. Select the sources to be searched and the type of documents to be retrieved (Figure 2.6) Each service requires that at least one corresponding document type is selected (e.g., the KNB Metacat EcoGrid QueryInterface service requires that either Ecological Metadata Language 2.0.0 or Ecological Metadata Language 2.0.1 is selected). If you try to 'deselect' all of the relevant document types, the service is automatically deselected as well. The document types (e.g., Ecological Metadata Language 2.0.0) refer to the metadata specification used by the data sets. For more information about metadata, please see Chapter 6.

⁹ Knowledge Network for Biocomplexity (KNB) website, <http://knb.ecoinformatics.org>

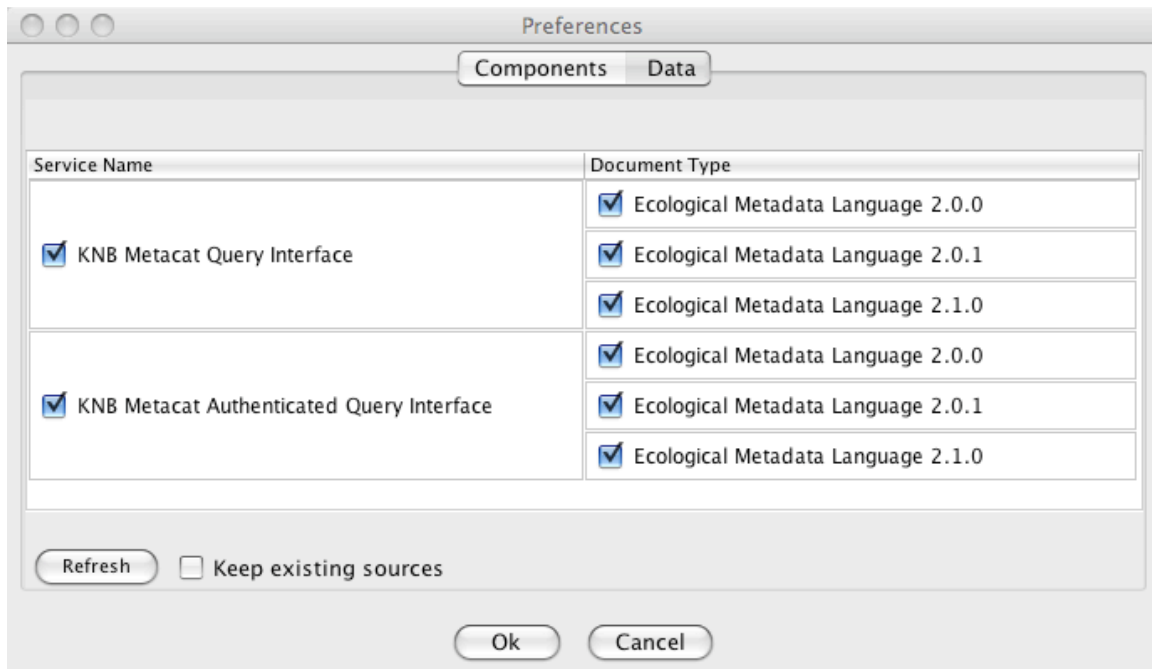

Figure 2.6: Configuring the data sources and types.

2.4.4 Workflow Canvas

Scientific workflows are opened, created, and modified on the Workflow canvas. Components are easily dragged and dropped from the Component and Data Access area to the desired canvas location, and can then be dragged around on the canvas. Each component is represented by an icon, which makes identifying the components simple. Connections between the components (i.e., channels) are also represented visually so that the flow of data and processing is clear.

Each time you open an existing workflow or create a new workflow, a new application window opens. Multiple windows allow you to work on several workflows simultaneously and compare, copy, and paste components between Workflow canvases.

2.4.4.1 Director Right-Click Menu

The director right-click menu contains several menu items that are specific to the director: Configure Director and Documentation.

Configure Director: Configure the director parameters. This dialog can also be opened by double-clicking the director on the Workflow canvas.

Documentation: Display, customize, or remove director documentation. Customized documentation will replace existing documentation.

2.4.4.2 Actor Right-Click Menu

The actor right-click menu contains several menu items that are specific to that actor: Configure Actor, Customize Name, Configure Ports, Configure Units, Open Actor, Get Metadata, Documentation, Listen to Actor, Suggest, Semantic Type Annotation, Save in Library..., Export Archive (KAR)..., Upload to Repository, and Convert to Class.

Configure Actor: Configure the actor parameters. This dialog can also be opened by double-clicking the actor on the Workflow canvas.

Customize Name: Customize the label that identifies the actor on the Workflow canvas.

Configure Ports: Add, remove, hide, show, rename, and customize input and output ports.

Configure Units: Specify unit constraints for an actor (e.g., $\$plus=\$minus$, which states that an actor's plus and minus ports must have the same units. For more information, please see the Ptolemy documentation, <http://ptolemy.berkeley.edu/ptolemyii/ptIIlatest/ptII/ptolemy/data/unit/demo/StaticUnits/NonAppletStaticUnits.htm>

Open Actor: Display the actor's Java source code in a viewing window.

Get Metadata: Display a data set's metadata. (For data actors only.)

Documentation: Display, customize, or remove director documentation. Customized documentation will replace existing documentation on the local copy of the actor in the current Kepler version. Note that customized documentation will not be "transferred" if a new version of Kepler is installed.

Listen to Actor: Open a window that displays various actor events during execution.

Suggest: Request that the semantic system suggest compatible input, output, or similar components.

Semantic Type Annotation: Semantic annotations conceptually describe an actor and/or its "data schema." Annotations provide the means for ontology-based discovery and integration. Annotations are stored within the component metadata. Each port can be annotated with multiple classes from multiple ontologies. Annotations can be used to find similar components, and to check that workflows are semantically and structurally well typed.

Save Archive (KAR): Save an archived version of the selected component to a selected location on the local machine.

Upload to Repository: Upload a component to the Kepler repository, which is a centralized server where workflow components can be searched and re-used. Uploaded components should have a unique name. To change the name of a component, right-click it and select Customize Name from the drop-down menu. Users will be prompted for a Knowledge Network for Biocomplexity (KNB) user name and password; if you do not have a KNB user account, click the Login Anonymously button to upload components without a user name or password. Alternatively, you can register for a KNB account on the KNB homepage (knb.ecoinformatics.org).

View LSID: View the unique life sciences identifier for this actor.

Preview: Display a data table. This option is only used by data actors (e.g., *EML2Dataset*) to display data sets represented by Meta data. For more information about using data sets in Kepler, please see Chapter 6 of the User Manual.

2.4.5 Navigation Area

The navigation area contains a view of the entire workflow (even if only a portion of the workflow is displayed on the Workflow canvas). Use the red guidelines to navigate a large workflow and select a portion of the workflow to display (*Figure 2.7*)

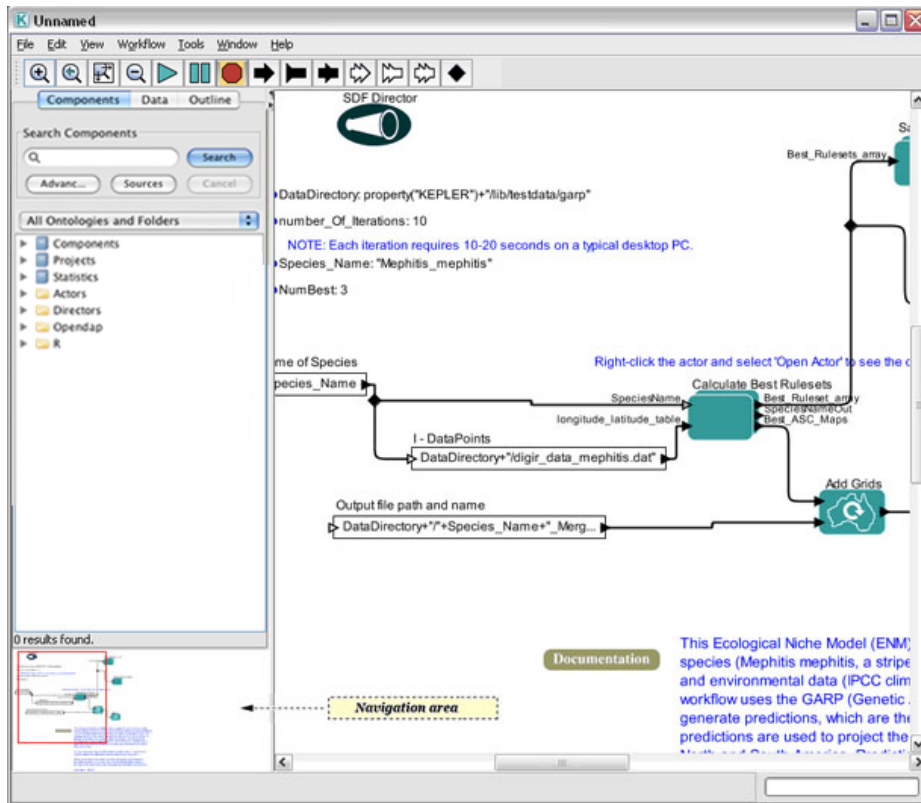

Figure 2.7: The Navigation area

3. Scientific Workflows

Kepler simplifies the effort required to analyze and model scientific data by using a visual representation of these processes. These representations, or “scientific workflows,” display the flow of data among discrete analysis and modeling components (*Figure 3.1*).

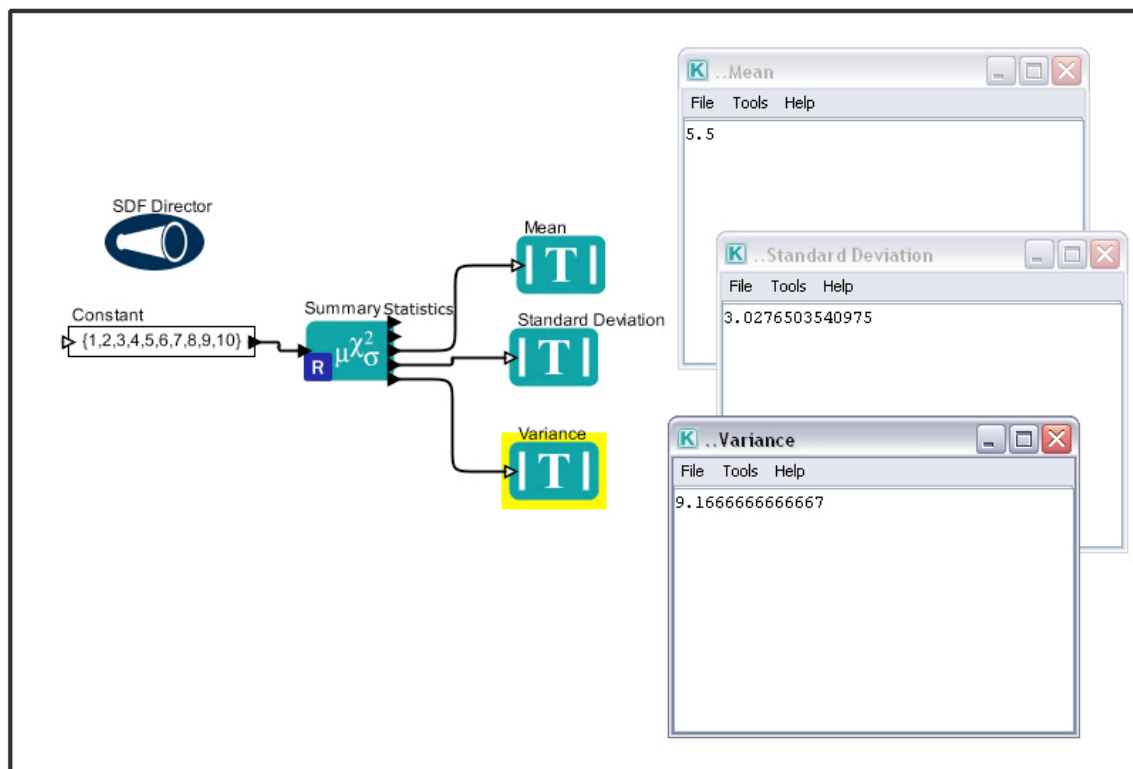

Figure 3.1: A simple scientific workflow developed in Kepler

Kepler allows scientists to create their own executable scientific workflows by simply dragging and dropping components onto a workflow creation area and connecting the components to construct a specific data flow, creating a visual model of the analytical portion of their research. Kepler represents the overall workflow visually so that it is easy to understand how data flow from one component to another. The resulting workflow can be saved in a text format, emailed to colleagues, and/or published for sharing with colleagues worldwide.

Kepler users with little background in computer science can create workflows with standard components, or modify existing workflows to suit their needs. Quantitative analysts can use the visual interface to create and share R and other statistical analyses. Users need not know how to program in R in order to take advantage of its powerful analytical features; pre-programmed Kepler components can simply be dragged into a visually represented workflow. Even advanced users will find that Kepler offers many

advantages, particularly when it comes to presenting complex programs and analyses in a comprehensible and easily shared way.

Kepler includes distributed computing technologies that allow scientists to share their data and workflows with other scientists and to use data and analytical workflows from others around the world. Kepler also provides access to a continually expanding, geographically distributed set of data repositories, computing resources, and workflow libraries (e.g., ecological data from field stations, specimen data from museum collections, data from the geosciences, etc.).

3.1 What is a Scientific Workflow?

Scientific workflows are a flexible tool for accessing scientific data (streaming sensor data, medical and satellite images, simulation output, observational data, etc.) and executing complex analysis on the retrieved data.

Each workflow consists of analytical steps that may involve database access and querying, data analysis and mining, and intensive computations performed on high performance cluster computers. Each workflow step is represented by an “actor,” a processing component that can be dragged and dropped into a workflow via Kepler’s visual interface. Connected actors (and a few other components that we’ll discuss in later sections) form a workflow, allowing scientists to inspect and display data on the fly as it is computed, make parameter changes as necessary, and re-run and reproduce experimental results.¹⁰

Workflows can represent theoretical models or observational analyses; they can be simple and linear, or complex and non-linear. One feature of some scientific workflow systems is that they can be nested (i.e., hierarchical), meaning that a workflow can contain “sub-workflows” that perform embedded tasks. A nested workflow (known in Kepler as a composite actor) is a re-usable component that performs a potentially complex task.

Scientific workflows in Kepler provide access to the benefits of today’s grid technologies (providing access to distributed resources such as data and computational services), while hiding the underlying complexity of these technologies. Kepler automates low-level data processing tasks so that scientists can focus instead on the scientific questions of interest.

Workflows also provide the following:

- documentation of all aspects of an analysis
- visual representation of analytical steps
- ability to work across multiple operating systems

¹⁰ Ludäscher, B., I. Altintas, C. Berkley, D. Higgins, E. Jaeger-Frank, M. Jones, E. Lee, J. Tao, Y. Zhao. 2005. Scientific Workflow Management and the Kepler System, DOI: 10.1002/cpe.994

- reproducibility of a given project with little effort
- reuse of part or all of a workflow in a different project

To date, most scientific workflows have involved a variety of software programs and sophisticated programming languages. Traditionally, scientists have used STELLA or Simulink to model systems graphically, and R or MATLAB to perform statistical analyses. Some users perform calculations in Excel, which is user-friendly, but offers no record of what steps have been executed. Kepler combines the advantages of all of these programs, permitting users to model, analyze, and display data in one easy-to-use interface.

Kepler builds upon the open-source Ptolemy II visual modeling system (<http://ptolemy.eecs.berkeley.edu/ptolemyII/>), creating a single work environment for scientists. The result is a user-friendly program that allows scientists to create their own scientific workflows without having to integrate several different software programs or enlist the assistance of computer programmers.

A number of ready-to-use components come standard with Kepler, including generic mathematical, statistical, and signal processing components and components for data input, manipulation, and display. R- or MATLAB-based statistical analysis, image processing, and GIS functionality are available through direct links to these external packages. You can also create new components or wrap existing components from other programs (e.g., C programs) for use within Kepler.

3.2 Components of a Workflow

Scientific workflows consist of customizable components—directors, actors, and parameters—as well as relations and ports, which facilitate communication between the components. *Figure 3.2* displays a Kepler workflow with the main workflow components identified.

The workflow in *Figure 3.2*, the LotkaVolterraPredatorPrey workflow, is used to model the relative populations of a predator and its prey over time. For a more detailed look at how it works, please see Section 4.2.3.

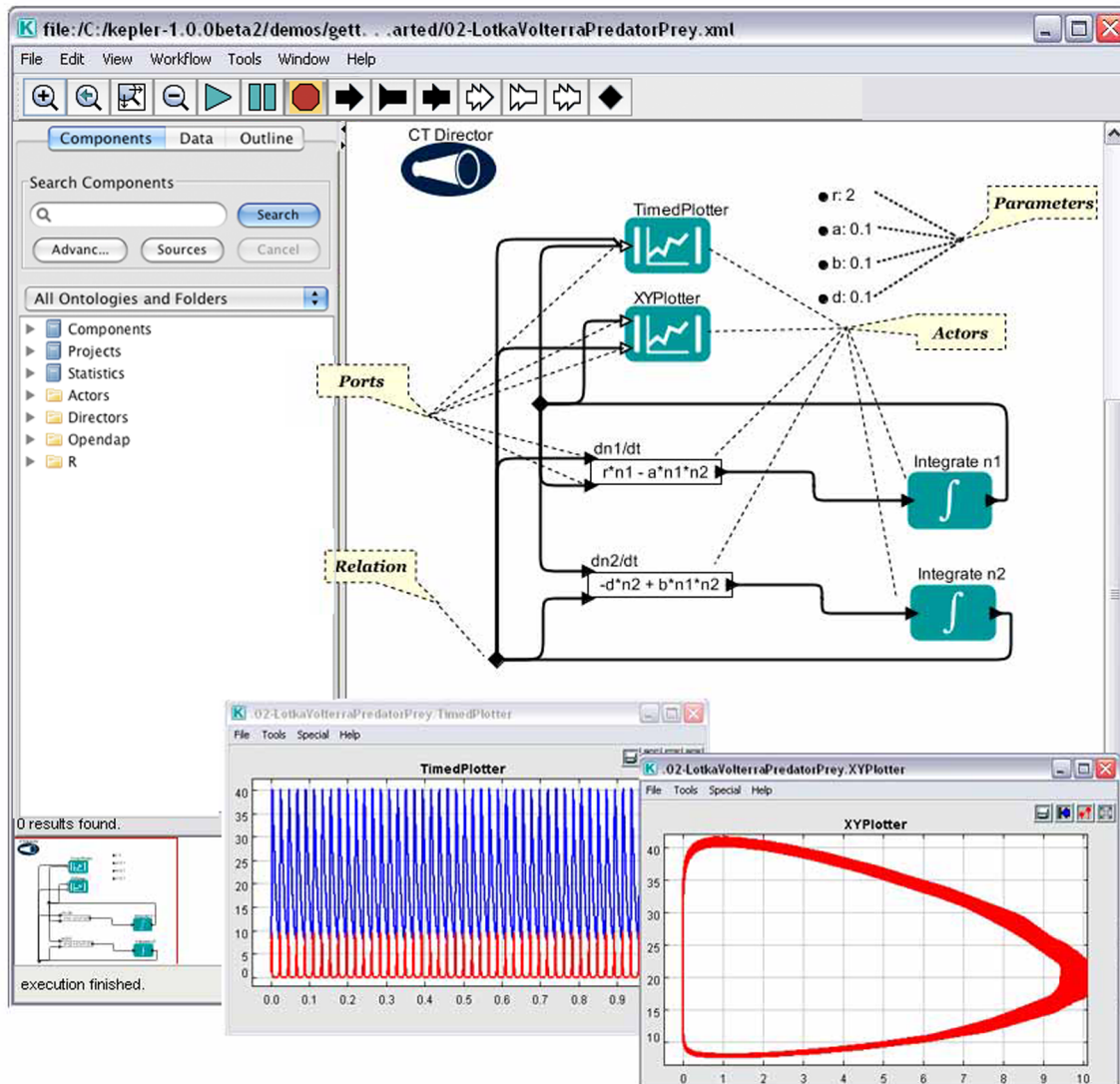

Figure 3.2: Main window of Kepler with some of the major workflow components highlighted. The windows on the bottom right are output windows, created by the workflow to display result graphs.

3.2.1 Directors

Kepler uses a director/actor metaphor to visually represent the various components of a workflow. A director controls (or directs) the execution of a workflow, just as a film director oversees a cast and crew. The actors take their execution instructions from the director. In other words, actors specify *what* processing occurs while the director specifies *when* it occurs.

Every workflow must have a director that controls the execution of the workflow using a particular model of computation. For example, workflow execution can be synchronous, with processing occurring one component at a time in a pre-calculated sequence (*SDF*

Director). Alternatively, workflow components can execute in parallel, with one or more components running simultaneously (which might be the case with a *PN Director*).

A small set of commonly used directors come packaged with Kepler (*Table 3.1*), but more are available in the underlying Ptolemy II software that can be accessed as needed. For a more detailed discussion of workflow models of computation, please see Section 5.2 Choosing a Director, or refer to the Ptolemy II documentation.







<p>SDF Director</p> 	<p>The <i>SDF Director</i> is often used to oversee fairly simple, sequential workflows. Types of workflows that run well under an <i>SDF Director</i> include processing and reformatting data, converting one data type to another, and reading and plotting a series of data points.</p>
<p>PN Director</p> 	<p>The <i>PN Director</i> is often used for managing workflows that require parallel processing on distributed computing systems.</p>
<p>CT Director</p> 	<p>The <i>CT Director</i> is designed to oversee workflows that predict how systems evolve as a continuous function of time (i.e., "dynamic systems").</p>
<p>Continuous Director</p> 	<p>The <i>Continuous Director</i> is for the "continuous time" domain, a timed domain that supports continuous-time signals, discrete-event signals, and mixtures of the two. There is a global notion of time that all the actors are aware of.</p>
<p>DE Director</p> 	<p>The <i>DE Director</i> is often used for modeling time-oriented systems: queuing systems, communication networks, and occurrence rates or wait times.</p>
<p>DDF Director</p> 	<p>The <i>DDF Director</i> is often used for workflows that use looping or branching or other control structures, but that do not require parallel processing (in which case a <i>PN Director</i> should be used).</p>

Table 3.1: Directors that come in the standard Kepler component library.

3.2.2 Actors

Actors are the basic building blocks of workflows. Kepler comes packaged with more than 350 actors, each ready to be used in new and/or existing scientific workflows. Each actor is designed to perform a specific task: from generating summary statistics, to mapping data points to a projection of North America, to translating files from one format to another. Each actor performs a "step" in a workflow. For example, one actor might be used to read or import data for use in a workflow, another to transform that data into a format that can be analyzed, another to analyze or graph the data, and another to output the data to a file or the screen. Data passes between these actors via channels, which are represented by solid lines on the Workflow canvas.

The actors are listed in the Components tab of the Kepler interface. Dragging and dropping an actor will move it to the Workflow canvas, where it can be incorporated into a workflow. However, simply dragging an actor onto the Workflow canvas will, by itself, do nothing. Though each actor knows "what" processing should occur, it does not know "when" to perform that process (or "iterate"). Actors need to be directed (i.e., they require a Director component) in order to perform.

Separating the "what" from the "when" in actor performance allows actors to act and interact in many ways. For example, an actor can be instructed to iterate once, or ten times, or infinitely with a simple Director setting. Similarly, an actor can be instructed to work in parallel with other actors—which is useful when workflows require parallel processing on distributed computing systems—or at discrete times along a time line, or in a number of other ways dictated by the Director. See Section 5.2 for more information about each Director and how to choose the right director for each workflow.

New actors can be downloaded from the Kepler repository, or created by the user and added to the Kepler application. User-created actors can also be uploaded to the Kepler repository, where they can be shared with other workflow developers. The Kepler repository is covered in more detail in Section 4.5.3. For more information about creating and using new actors, see the appendix on Creating New Actors.

Kepler actors come in two forms: "individual" actors and "composite" ones. Composite actors are collections or sets of individual actors bundled together to perform more complex operations. Composite actors can be used in workflows, essentially acting as a nested or sub-workflow (*Figure 3.3*). An entire workflow can be represented as a composite actor and included as a component within an encapsulating workflow. Composite actors are designated with a double rectangle actor icon.

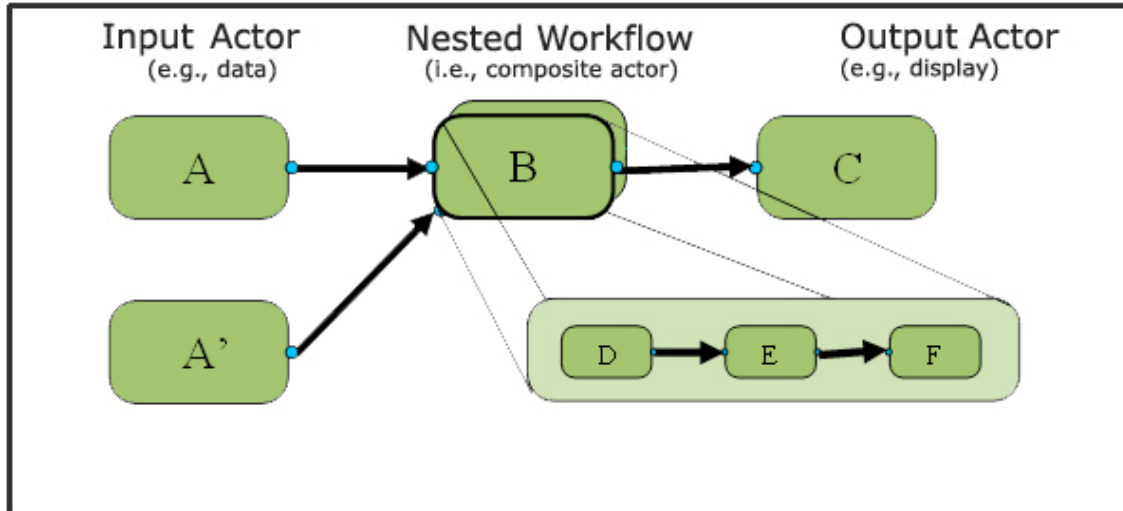

Figure 3.3: Representation of a nested workflow. "B" is an example of a composite actor, which contains three nested actors (D, E, and F).

Both individual and composite actors are identified by an icon and a label, which are rendered on the Workflow canvas. In addition, most actors have one or more ports, which are used either to input values (a dataset to analyze, for example) or to output results. Most actors have parameters, as well, which are customizable settings. To view and/or edit an actor's parameters, double-click the actor icon on the Workflow canvas.

Figure 3.4 shows a *Round* actor as it appears on the Workflow canvas. The *Round* actor has two ports, an input and an output port, as well as one parameter (function). Double-click the actor to view and/or edit the function parameter.

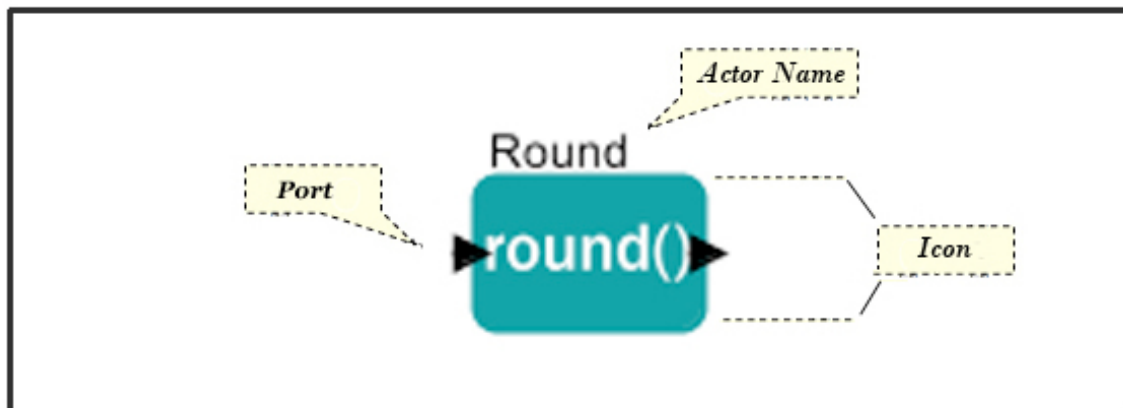

Figure 3.4: The *Round* actor as it appears on the Workflow canvas

Actor Name: The actor name can be customized to specifically identify an actor's function in a workflow. For example, a Display actor can be renamed "Display Statistics" or "Display Errors" to better identify its purpose in a specific workflow. To edit an actor name, right-click the actor icon from the Workflow canvas and select Customize Name from the menu. The actor name is displayed above the actor icon unless the "Show name" option in the Customize Name menu is deselected.

Icon: Each actor is identified by an icon that describes the actor on the Workflow canvas. Icons help identify the function of each actor. For a complete list of actor icons and a description of Kepler actor symbology, see Section 5.3.1 Actor Icon Families.

Ports: Most actors have one or more ports, depicted with either a white (multiport) or black (single port) triangle at the perimeter of the actor icon. Data flows into and out of the actor via these ports. To add, remove, or rename actor ports, right-click the actor icon and select Configure Ports from the menu. Checking "Show Name" displays the port name on the Workflow canvas.

Data is passed to actor ports in the form of tokens. A token can be thought of as a container of some kind of data. Each token has a type ("integer" or "matrix," for example), and this type is usually declared by the port that accepts or broadcasts the data. Mouse over an actor port on the Workflow canvas to display a tooltip that contains the port name as well as the type of data it produces or accepts. If the actor does not receive data tokens of the specified type, an error will be generated.

Parameters: Double-click an actor icon on the Workflow canvas to reveal the actor's parameters, or settings. Parameters are used to give actors context-specific instructions, such as the location of a source file to read, a particular algorithm to perform, and the format in which to output results.

Each time an actor is dragged onto the Workflow canvas from the Components tab, a new "instance" of that actor is created. Dragging and dropping an *ImageJ* actor onto the canvas three times will produce three instances of the *ImageJ* actor, named ImageJ, ImageJ2, and ImageJ3. Editing the parameters of any one of these instances does not affect the values of the other instances, nor does it affect the original actor stored in Kepler. In other words, every time an actor is instantiated, it will have the same settings as the original actor (or "class", in Java). The name of each actor class can be viewed by right-clicking an actor and selecting Documentation from the drop-down menu. The class name is displayed in parenthesis beside the actor name, e.g., ImageJActor (Instance of util.ImageJActor).

Documentation: All Kepler actors have documentation, which can be opened via the actor's right-click menu. To read the actor documentation, drag an actor onto the Workflow canvas, right-click the actor icon, and select Documentation > Display from the pop-up menu (*Figure 3.5*). Documentation can also be accessed from the Components tab: simply right click an actor and select View Documentation. The documentation describes each actor and its function, the type of values the actor inputs and outputs, and the purpose of each actor parameter.

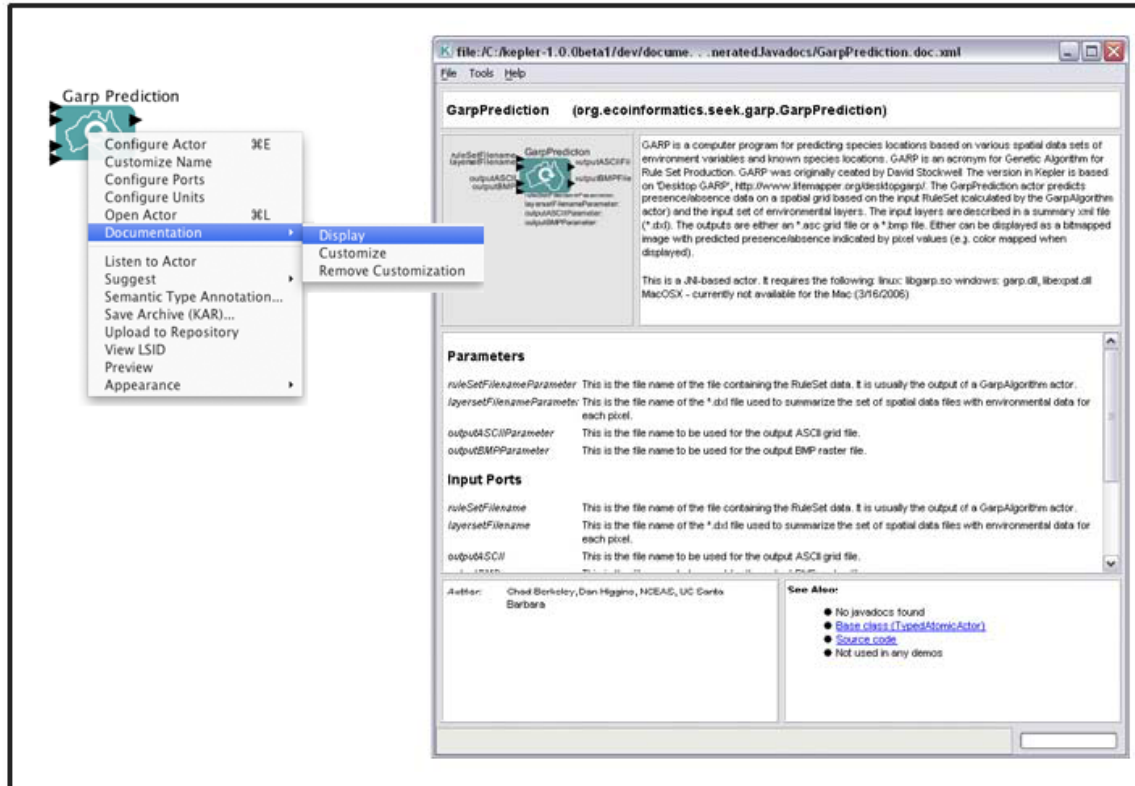

Figure 3.5: Actor documentation

The actor documentation can also be customized by right-clicking the actor and selecting Documentation > Customize from the drop-down menu. An editing window opens (Figure 3.6).

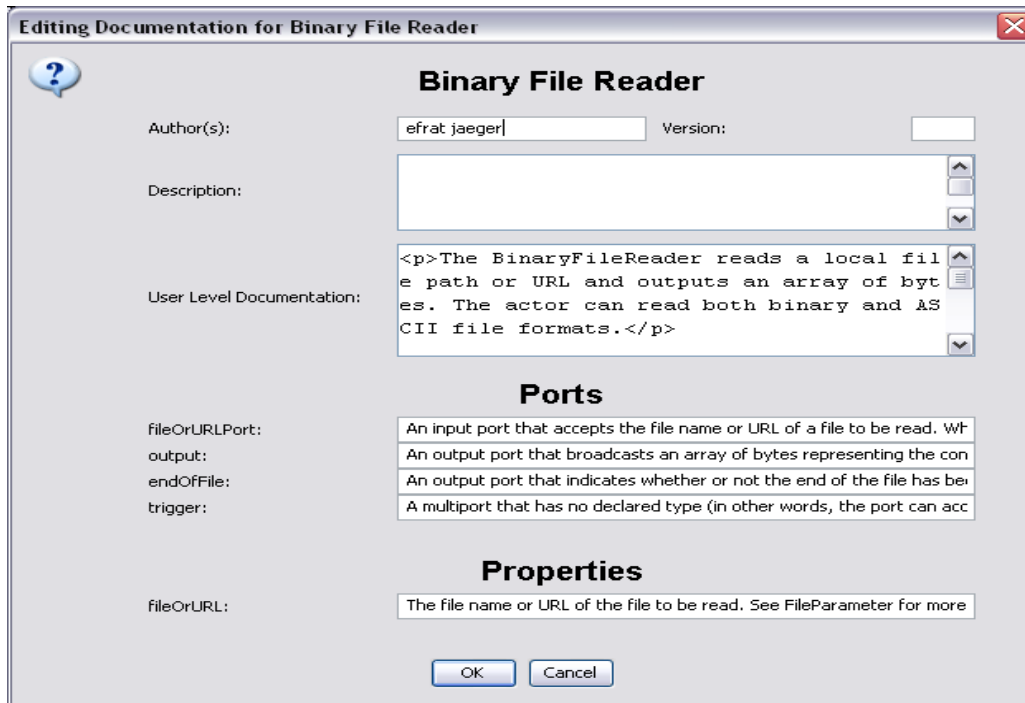

Figure 3.6 Editing actor documentation.

Documentation content can include links to external web pages (which will open in a Kepler viewing window) and HTML formatting (``, `<tt>`, ``, etc). XML-reserved characters (e.g., `'>`, `'&`, `'"`, etc) must be escaped. The most common reserved characters and their entity replacement are listed in *Table 3.2*

XML-reserved Character	Replace with:
&	&
<	<
>	>
"	"
'	'

Table 3.2: Common XML-reserved characters.

To delete the content of a documentation screen, select `Documentation > Remove Customization`. Note that this action cannot be undone with the "Undo" Menu bar item.

Actors make it easy to "read" the architecture of a workflow. When an existing workflow is opened (or a new workflow is created), each actor appears on the Workflow canvas, allowing users to easily follow the workings of the process that the workflow performs. Users can delve even deeper into the details of workflow processing by opening the actors. To open an actor, right-click the actor icon from the Workflow canvas and select `Open Actor`. For most individual actors, Kepler will display the Java source code (*Figure 3.7*). The Java source is the code that creates the actor; some actors, such as the *RExpression* actor, contain code (e.g., R-scripts), but this type of code is accessed via actor parameters. In some cases, like the *EML2Dataset* actor, a customized display of information about the actor appears when the actor is opened. If the actor is a composite actor, a new application window opens to display the sub-workflow (*Figure 3.8*).

Actors are written in Java, which is an object-oriented programming language created by [Sun Microsystems](#). (Note that existing code written in languages other than Java can be included in Kepler by writing a Java "wrapper" around the code). A technical specification of actor structure is beyond the scope of this manual, which instead focuses on how actors are used and appear in the user interface. For more technical information about actor code and coding practices, please see the [Ptolemy documentation](#) as well as the [Kepler developer documentation](#).

3.2.3 Composite Actors

Composite actors are collections or sets of actors bundled together to perform more complex operations. Composite actors can be used in workflows, essentially acting as a nested or sub-workflow. An entire workflow can be represented as a composite actor and included as a component within an encapsulating workflow. In more complex workflows, it is possible to have different directors at different levels. A sub-workflow that contains its own director is called an opaque composite. Transparent composites "inherit" their director from the containing workflow (i.e., the sub-workflow does not contain its own director).

Opaque Composite actors are sub-workflows that contain their own director. Opaque composite actors can be nested inside workflows that use a different type of director, thereby combining different models of computation in one workflow; however, not all directors are compatible. An opaque composite actor that uses a PN director cannot be nested inside a workflow governed by an SDF director, for example. For an in-depth discussion of directors that can be compatibly nested, see [Composing Models of Computation in Kepler/Ptolemy](#).

3.2.4 Ports

Each actor in a workflow can contain one or more ports used to consume or produce data and communicate with other actors in the workflow. Actors are connected in a workflow via their ports. The link that represents data flow between one actor port and another actor port is called a channel. Ports are categorized into three types:

- [input port](#) – for data consumed by the actor;
- [output port](#) – for data produced by the actor; and
- [input/output port](#) – for data both consumed and produced by the actor.

Each port is configured to be either a “singular” or “multiple” port. A single input port can be connected to only a single channel, whereas a multiple input port can be connected to multiple channels. The "width" of the port describes how many channels of data it accepts; the width of a single port can be 0 (unconnected) or 1, while the width of a

multiple port can be greater than 1. For multiple ports, the first channel is number 0, the second 1, etc. See Section 3.2.5 for more information about channels.

Several different kinds of ports appear in Kepler: actor ports, external ports, and port-parameters. Each is discussed in more detail in the following sections.

3.2.4.1 Actor Ports

Actor ports, also called coupled ports, are coupled with an actor. Actor ports appear as light or dark triangles on the actor icons when actors are displayed on the Workflow canvas (*Figure 3.9*), and can be customized by right-clicking an actor and selecting Customize Ports from the drop-down menu.

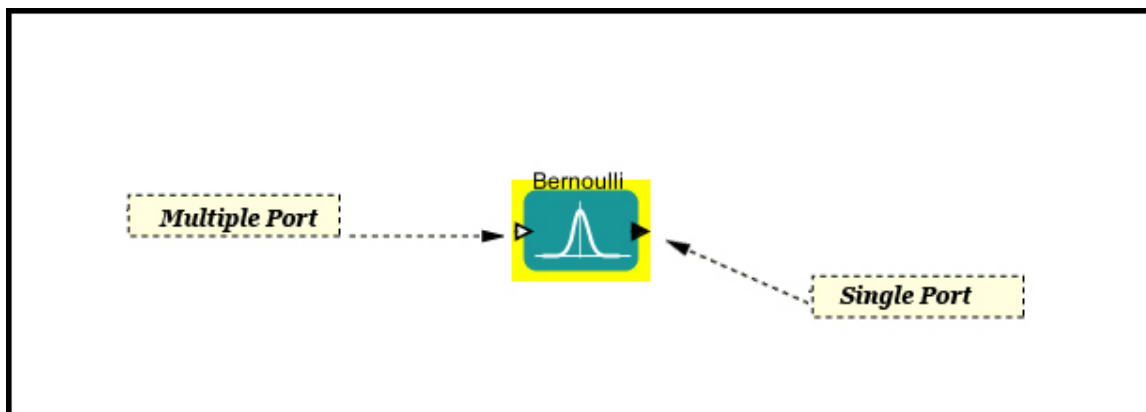

Figure 3.9: Single and multiple ports of the *Bernoulli* actor. A single port can be connected to a single channel of data, while a multiple port can be connected to multiple channels.

To customize an actor's ports—either by changing the existing ports or adding new ones—right-click the actor and select Configure Ports from the drop-down menu (*Figure 3.10*)

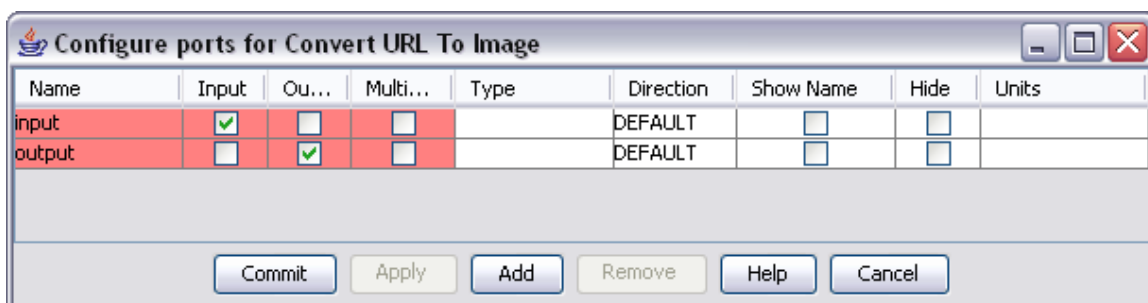

Figure 3.10: Configuring the ports of the *ConvertURLTo Image* actor. Fields that cannot be edited are noted with a pink highlight.

To add a new port, click the Add button and then customize the new port. Every port must have a name, which can be customized by double-clicking the field in the Name column and typing a name. In addition to selecting the kind of port (input, output or input/output), users can assign a data type by clicking the Type field and selecting a type

from the drop-down menu. The port Direction field determines how the port will be displayed on the Workflow canvas ("North" places the port at the top of the actor, "South" on the bottom, etc). Kepler will display the port name on the Workflow canvas if "Show Name" is selected, and will hide the port (i.e., not show it on the Workflow canvas) if "Hide" is selected. Adding ports is essential to some actors (like the *Expression* actor). In other cases, adding ports is relatively meaningless since the actor is not designed to use any information on the added port.

Units (seconds, meters, etc) can be selected by clicking the Units field and selecting a measurement from the drop-down menu. Assigning units helps insure the integrity of workflow processing (e.g., that meters are not added to miles per second, etc). If units are assigned, the Unit Constraints Solver (accessed by right-clicking the Workflow canvas and selecting Unit Constraints Solver from the drop-down menu) can be used to discover, analyze, and, in some cases, fix, unit inconsistencies that exist in a model.

Each port can also be assigned a data type (e.g., double or array; See Section 3.2.6 for more information about data types). The type of the port restricts the type of the token that can pass through it. These types can be declared via the Type drop-down menu, or left undeclared, in which case the application will resolve the type when the workflow is executed. In many cases there is no need to enter port type information.

3.2.4.1 External Port

An external port is often used to pass data from a sub-workflow to a containing workflow (*Figure 3.11*). External ports can be connected by channels to other external ports or to ports of individual actors.

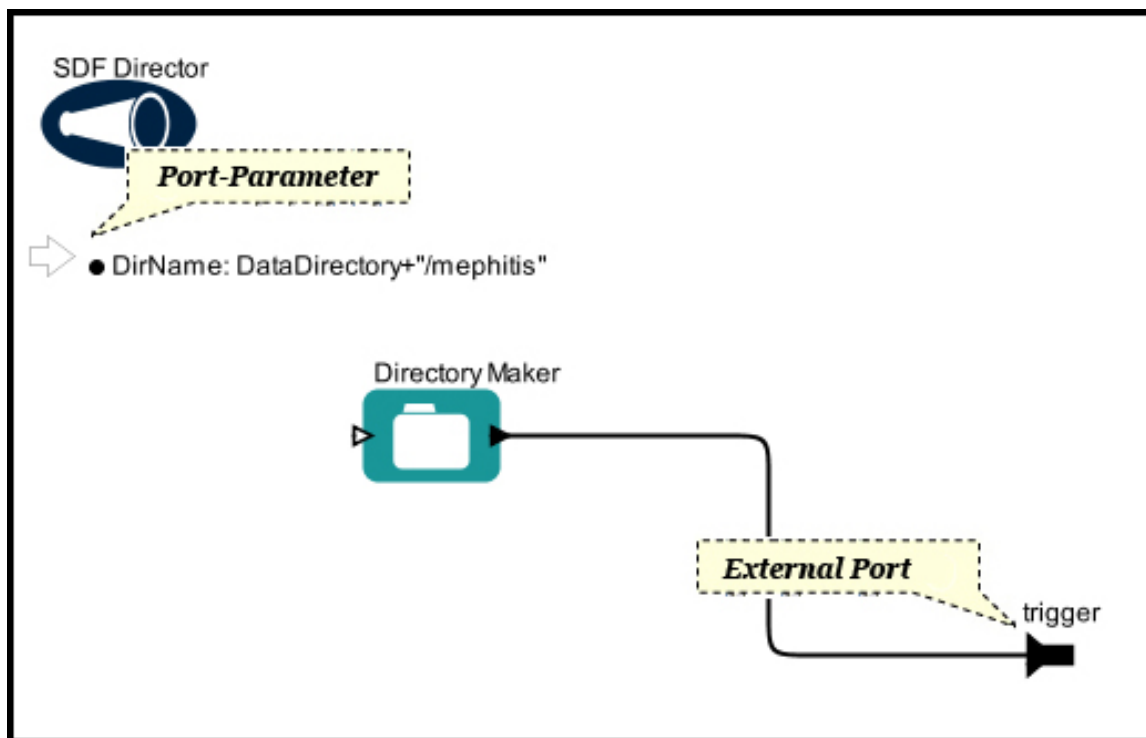

Figure 3.11: Example of an external output port ("trigger") and an input port-parameter ("DirName"). This simple workflow is a sub-workflow of the GARP_SingleSpecies_BestRuleSet-IV.xml workflow. The sub-workflow passes a trigger to the containing workflow via its external `trigger` port. The `DirName` port-parameter is discussed in greater detail in Section 3.2.4.3.

Like actor ports, external ports can be singular or multiple. They can be added to a workflow with the Toolbar buttons. The ports are represented on the Workflow canvas with the same icon that appears on the Toolbar buttons (*Table 3.3*)

Icons for external ports

	Single input port.		Multiple Input Port
	Single output port.		Multiple Output Port
	Single Input/Output Port		Multiple Input/Output Port

Table 3.3: Icons that represent the various types of external ports on the Workflow canvas

3.2.4.3 Port-Parameter

A port-parameter functions as both a port and a parameter that is used to configure the operation of an actor (for more information about parameters, see Section 3.2.8). Port-parameters allow users to specify a "default" value for a parameter (e.g., iterations=4 or name="mouse"). If the actor receives a value via the coupled port, that value will replace the value specified by the parameter component of the port-parameter.

Port-parameters can be added to workflows from the Components tab by searching for "PortParameter" and dragging the component onto the Workflow canvas.

To customize a port-parameter on the Workflow canvas, right-click the port-parameter and select Customize Name from the drop-down menu. A dialog window provides a field for specifying a name (*Figure 3.12*). Choose a descriptive name and click Commit.

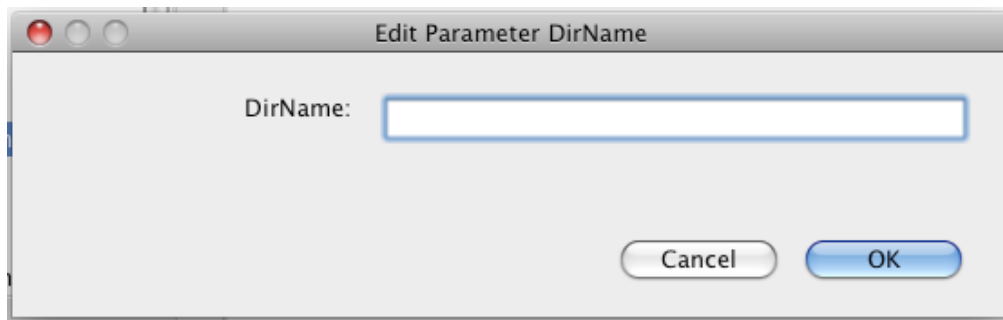

Figure 3.12: Customizing the name of the port-parameter used in the GARP_SingleSpecies_BestRuleSet-IV.xml workflow displayed in *Figure 3.11*.

Once the port-parameter has been named, specify a parameter value by double-clicking the port-parameter (*Figure 3.13*).

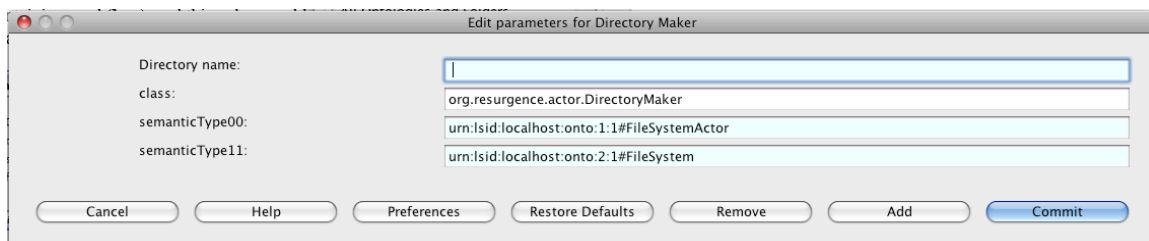

Figure 3.13: Customizing the parameter value of a port-parameter.

Note: The parameter value in *Figure 3.13*, `DataDirectory+"/mephitis"`, is an example of an expression, which is written in the Kepler expression language, and is the value of the port-parameter used in the sub-workflow displayed in *Figure 3.11*. `DataDirectory` is a parameter defined by the containing workflow, and `"/mephitis"` is a string that will be concatenated to form the name of the new directory created by the *DirectoryMaker* actor. Parameter values can also be constant values, such as integers or strings.

Once the port-parameter has been defined, actors can reference it. *Figure 3.14* displays the *DirectoryMaker* actor's parameters. Note that the value of the "Directory name" parameter is set to `$DirName`. The "\$" syntax is used to tell Kepler to substitute the value of a string parameter for the parameter name (i.e., `DirName` is the parameter name in this example, NOT the name of a directory). The value of `DirName` is: `DataDirectory+"/mephitis"`. The actor will use this value unless the port-parameter receives an alternate string from the containing workflow. In the GARP workflow, the port-parameter is configured to receive `DataDirectory+"/"+SpeciesName` (where `SpeciesName` is defined elsewhere in the containing workflow), and this value would replace the default `Directory` name parameter.

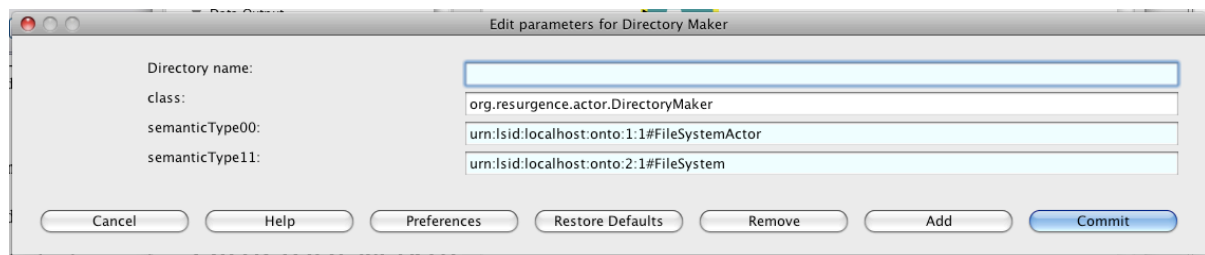

Figure 3.14: Referencing a port-parameter. The `$DirName` syntax is used to refer to the value of the `DirName` port-parameter defined on the Workflow canvas.

3.2.5 Channels and Tokens

Channels are used to pass data from one port to another. Each channel can transport a single stream of data. Data in Kepler is encapsulated and passed between workflow components as tokens. Each token has an assigned data type (int, object, or matrix, for example).

Channels are represented as solid lines that "connect" the actors on the Workflow canvas. To create a channel, left-click an actor's input or output port and drag the cursor to the destination actor's input/output port. Until the channel is properly connected to both the source and destination ports, the channel will appear as a thin black line. Once the channel is connected, it will become a thick black line (*Figure 3.15*). To disconnect or re-route one end of a channel, first select the channel by left-clicking somewhere along the black line, then click-and-drag the appropriate end point to the desired location on the Workflow canvas.

The simple addition/subtraction workflow displayed in *Figure 3.15* contains two channels of data that are input to an *Add or Subtract* actor via its multiport. The first channel is number 0, the second number 1 (a third would be number 2, etc.).

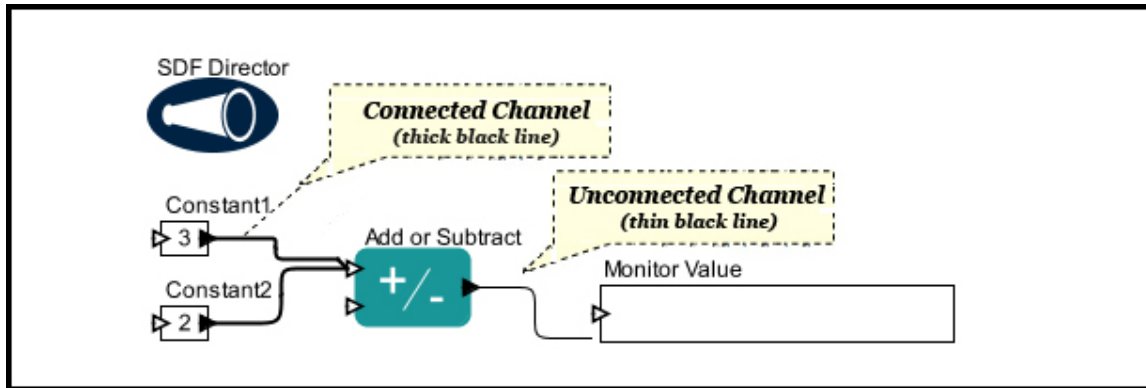

Figure 3.15: Channels on the workflow canvas. When a channel is properly connected, it will be represented by a thick black line. Channels that are not properly connected appear as thin black lines.

3.2.6 Data Types

Data tokens each have a structural type. "Hello", a string of alpha-numeric characters, is encapsulated as a string token, while 3, an integer, is encapsulated as an integer token. String and integer are both structural types.

A data token can only be passed to a port that accepts its structural type. An array of strings cannot be passed to a port that accepts only integers, and attempting to do so will generate a type error. Port data types are defined by the actor, and can be configured by right-clicking an actor and selecting *Configure Ports* from the drop-down menu. That menu contains common Kepler data types, defined in *Table 3.4*. Note that this list is not exhaustive. For example, users can edit the results from the drop-down type menu to convert 'ArrayType[int]' to 'ArrayType[double]'

Structural Data Types

Boolean	The Boolean token can have one of two values: true or false (represented by 1 or 0, respectively).
Complex	A complex number consists of a real and imaginary part. In Kepler, the imaginary component of a complex number is designated with an i or j (e.g., 6+7i).
Double	A double represents a floating point number (e.g., 1.345) with "double precision". This data type can accurately represent about twice as many significant digits as a single precision type, but also requires more memory.
Fixed point	A fixed-point number is a number in which the position of the decimal point is constant. U.S. currency can be represented by a fixed-point number that has two digits to the right of the decimal point, for example. Fixed point numbers in Kepler are represented in the following way: fix(value, integerBits, fractionBits).
General	The general data type is the most inclusive of the types. A

	port assigned type "general" can accept data of all types (array, string, matrix, etc.).
Int	The integer token ("int") represents numerical values that have no decimal points (e.g., 11 or -17)
Long	Integers followed by an "l" or "L" are of type long. The long data type can represent large integers. Float and double data types can also be used: these data types have greater storage capacity than long data types, but less precision/significant digits.
Matrix	A matrix contains <i>boolean</i> , <i>complex</i> , <i>double</i> , <i>fixedpoint</i> , <i>int</i> , or <i>long</i> data that can be referenced by row and column. Matrices in Kepler are specified with brackets. Commas separate row elements and semicolons separate rows. For example, a 1x3 matrix would be represented as [1,2,3]. A 2x2 matrix would be represented by [1,2;3,4]. To create multidimensional matrices, use arrays of arrays of arrays.
Object	An object token is a data container for an arbitrary Java object (most complex 'things' in Java are objects). These tokens can be used to pass complex Java objects around a Kepler workflow. Object tokens are primarily used for custom workflows with custom actors. Non-programmers will probably not find them very useful.
Scalar	The term scalar designates a value that consists only of magnitude (as opposed to a vector, which consists of both a magnitude and direction). In Kepler, scalar values may have any scalar data type: double, int, long, etc.
String	A sequence of characters specified within quotation marks. Anything between "" is interpreted as a string.
Unknown	An unknown data type places no additional type constraints on the port. All the structured types are less than the type "general" and greater than "unknown."
Unsigned byte	An unsigned byte represents an integer that does not include data to specify whether it is positive or negative.
xml token	Extensible Markup Language (XML) tokens use markup language to describe the structure of the data. For more information about XML, see the World Wide Web Consortium .
arrayType(int)	An array is a data structure consisting of elements that can be identified by a key (or index). The first item in an array has a key of 0, the second 1, etc. Arrays in Kepler are denoted with curly braces, e.g. {1,2,3,4,5} arrayType(int) specifies an array of integers. Note that any type in the drop-down menu can be edited so that different array types can be specified.
arrayType(int,5)	An array is a data structure consisting of elements that can

	be identified by a key (or index). <code>arrayType(int, 5)</code> specifies an array of integers with 5 elements in the array (i.e., the length of the array is specified as part of the type). Note that any type in the drop-down menu can be edited so that different array types and lengths can be specified.
[Double]	A matrix with elements of type double.
{x=double, y=double}	A record token consists of named elements and their values. In Kepler, records are specified between curly braces. For example, <code>{a=1, b=2}</code> is a record with two elements, named a and b, with values 1 and 2, respectively. In this case, both values are of type double.

Table 3.4: Common data types in Kepler

Kepler will attempt to automatically convert data into the appropriate structure. For example, if an integer and a double are added, Kepler will determine that the result will be type double (which is the "greater" of the two data types). For a detailed discussion about type conversion and resolution see the [Ptolemy documentation](#).

3.2.7 Relations

Relations allow workflows to “branch” a data flow. Branched data can be sent to multiple places in the workflow. For example, a user might wish to direct the output of an operational actor to another operational actor for further processing, and to a display actor to display the data at that specific reference point. By placing a Relation in the output data channel (*Figure 3.16*), the user can direct the information to both places simultaneously.

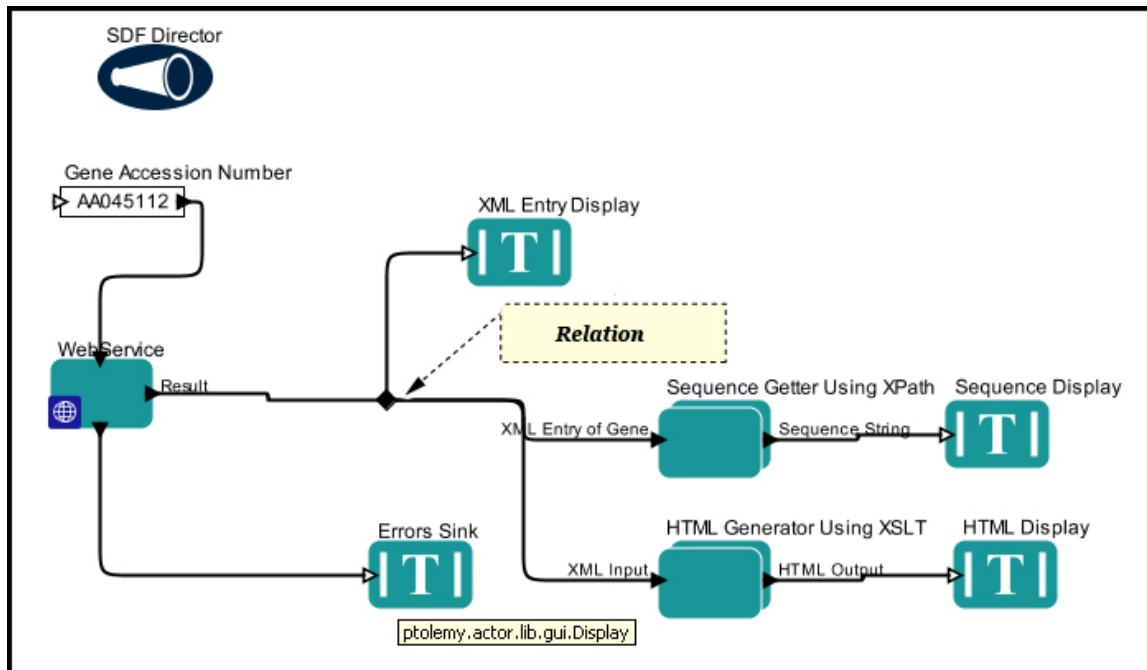



Figure 3.16: A relation is used to branch the Result output of the *WebService* actor to an *XML Entry Display* actor and two additional processing components: *Sequence Getter Using XPath* and *HTML Generator Using XSLT*.

To add a relation to a workflow, use the Add Relation button on the Toolbar (). The relation will be placed in the center of the Workflow canvas. Drag and drop it to the required location. When connecting a relation to actors, it is often easiest to begin drawing the channel at the input or output port of the actor and connecting the channel to the relation.

3.2.8 Parameters

Parameters are configurable values that can be attached to a workflow (model parameters) or to individual directors or actors (coupled parameters). Actor parameters specify everything from the directory into which the actor should save its output, to the name applied to the output file, to the number of items the actor should process. Director parameters control the number of workflow iterations and the relevant criteria for each iteration. Model parameters define values that can be adjusted in the Runtime window. More information about each type of parameter is contained in the following sections.

3.2.8.1 Actor Parameters

Actor parameters (or "coupled parameters") are parameters that belong to an actor or director. To view or edit these parameters, right-click the actor or director on the Workflow canvas and select Configure Actor from the drop-down menu, or simply double-click the component. This opens dialog box containing all of the relevant

parameters. *Figure 3.17* shows a dialog box that contains the parameters of the *Display* actor.

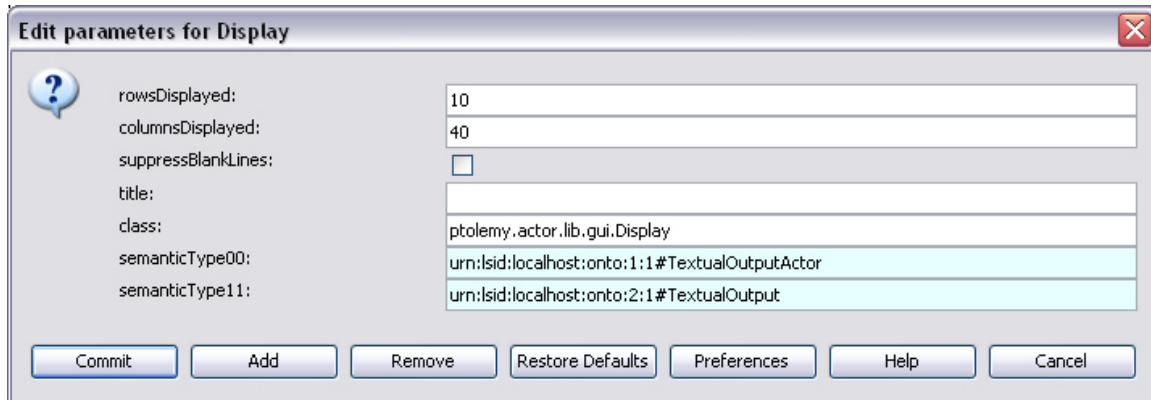

Figure 3.17: Parameters of the *Display* actor.

To edit the parameter values, simply change the fields and click the Commit button. In most cases, values must be modified before the workflow begins running; in other words, changes to parameter values will not go into effect if the workflow is already running.

Parameters can be added, removed, or restored to their default values via the corresponding buttons. Click Preferences to customize the type of field used to edit the parameters: text, fixed, line, or check box (*Figure 3.18*).

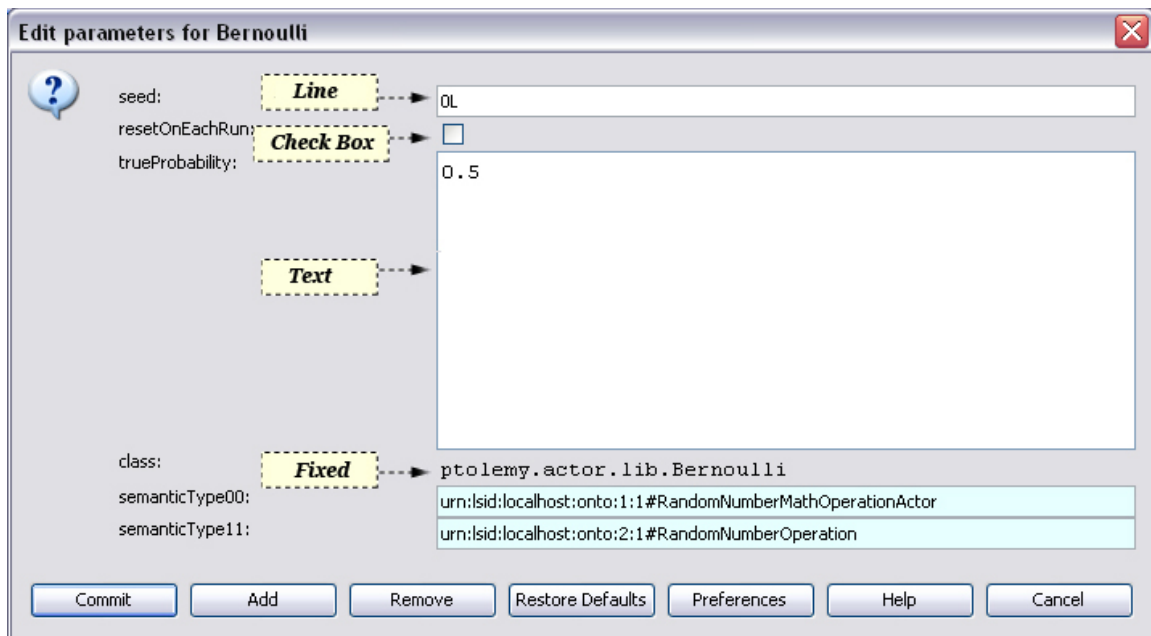

Figure 3.18: The Preferences button is used to manage the types of fields used to edit parameter values. The pictured parameters are for the *Bernoulli* actor, which is used to generate and output a sequence of random Boolean values.

3.2.8.2 Model Parameters

Model parameters appear directly on the workflow canvas and are used to specify values for anything from a color, to a file name, to a required version number (*Figure 3.19*). Model parameters can be added to a workflow from the Components tab.

To customize the value of a model parameter, double-click the parameter on the Workflow canvas, type a value into the editable field, and click OK. Alternatively, model parameters can be adjusted in the Runtime window, which is accessed via the Workflow menu.

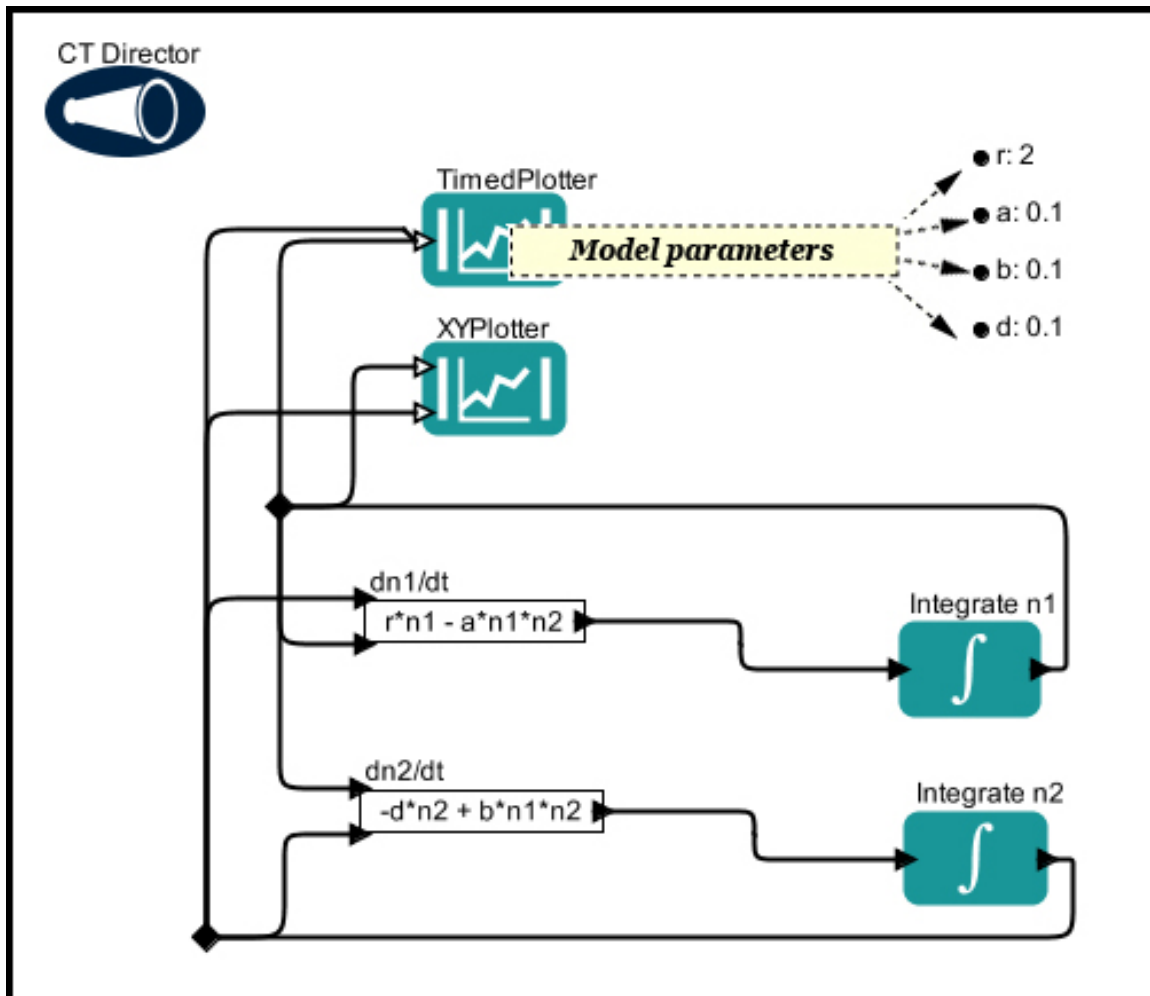

Figure 3.19: Model parameters, which is set on the Workflow canvas. Model parameters can be referenced by any actor in the workflow and its sub-workflows.

Parameter values can be referenced by any actor in the workflow or its sub-workflows. Actors reference model parameters by name. For example, the *ClimateFileProcessor* actor in *Figure 3.20* references the `OutputDir` model parameter in its `baseOutputFileName` parameter.

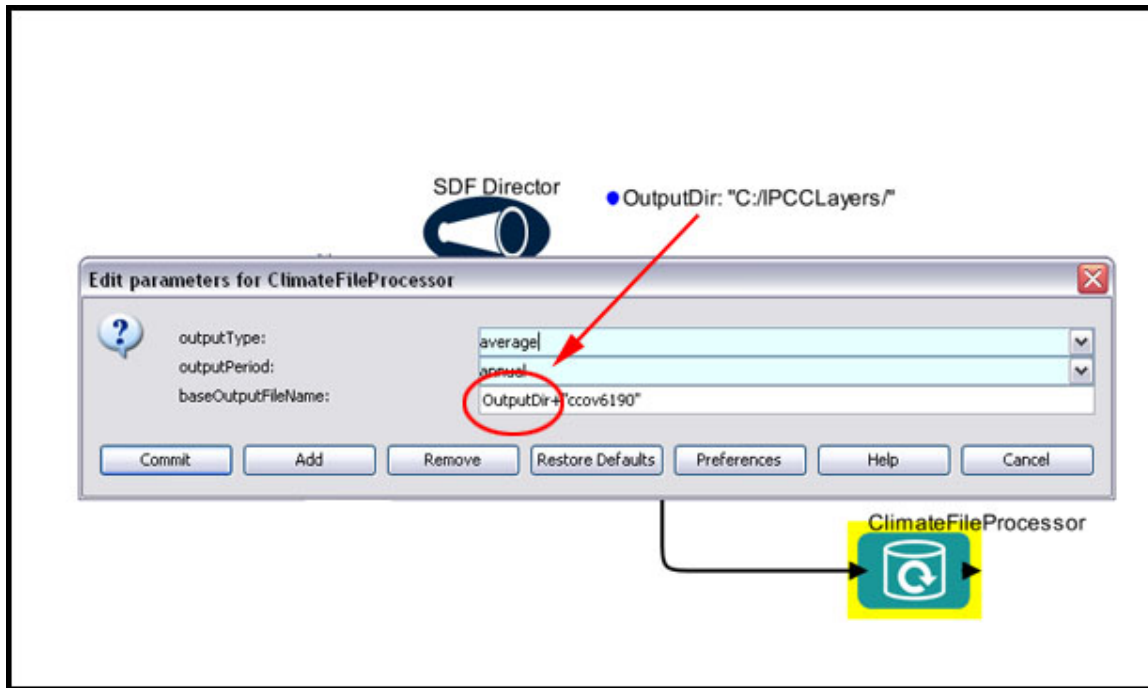

Figure 3.20: Referencing a model parameter.

3.2.8.3 Port-Parameters

A port-parameter functions as both a port and a parameter that is used to configure the operation of an actor. For more information about Port-Parameters, see Section 3.2.4.3.

4. Working with Existing Scientific Workflows

Kepler comes with a set of documented workflows contained in the "demos" directory and its subdirectories. The workflows in the "demos/getting-started" directory are useful examples that can help users familiarize themselves with the application, and many of the workflows contained in that directory are described in more detail later in this chapter.

In this chapter, we also cover how to open workflows created and shared by colleagues, and how to modify and save existing workflows.

4.1 Opening Workflows

Kepler can open both local workflows and workflows stored on a remote Web server. In both cases, the open workflow will display on the Workflow canvas, where it can be run and/or modified.

4.1.1 Opening Local Workflows

The workflows shipped with Kepler are installed into the "KeplerData/workflows/module/outreach-2.X.Y/demos/getting-started/" directory (where X.Y is the current version of Kepler, and KeplerData/ is inside your Documents and Settings directory on Windows, and your home directory on Linux and Mac), though workflows can be stored and opened from any local directory.

To open an existing local XML (MoML) workflow:

1. From the Menu bar, select File, then Open MoML. A standard file dialog box will appear.
2. If the file dialog box does not open to the "KeplerData" directory (the place where user workflows and data are stored), then navigate to the "KeplerData" directory (in your home directory).
3. Double-click a workflow file to open it (or single-click to select the file and then click the Open button). The workflow will appear on the Workflow canvas.

For example, to open the Lotka-Volterra workflow, the classic predator-prey model that is shipped with the Kepler application:

1. From the Menu bar, select File, then Open MoML.

2. Navigate to the “KeplerData/workflows/module/outreach-2.X.Y/demos/getting-started/” directory and locate the file named “02-LotkaVolterraPredatorPrey.xml” (*Figure 4.1*).

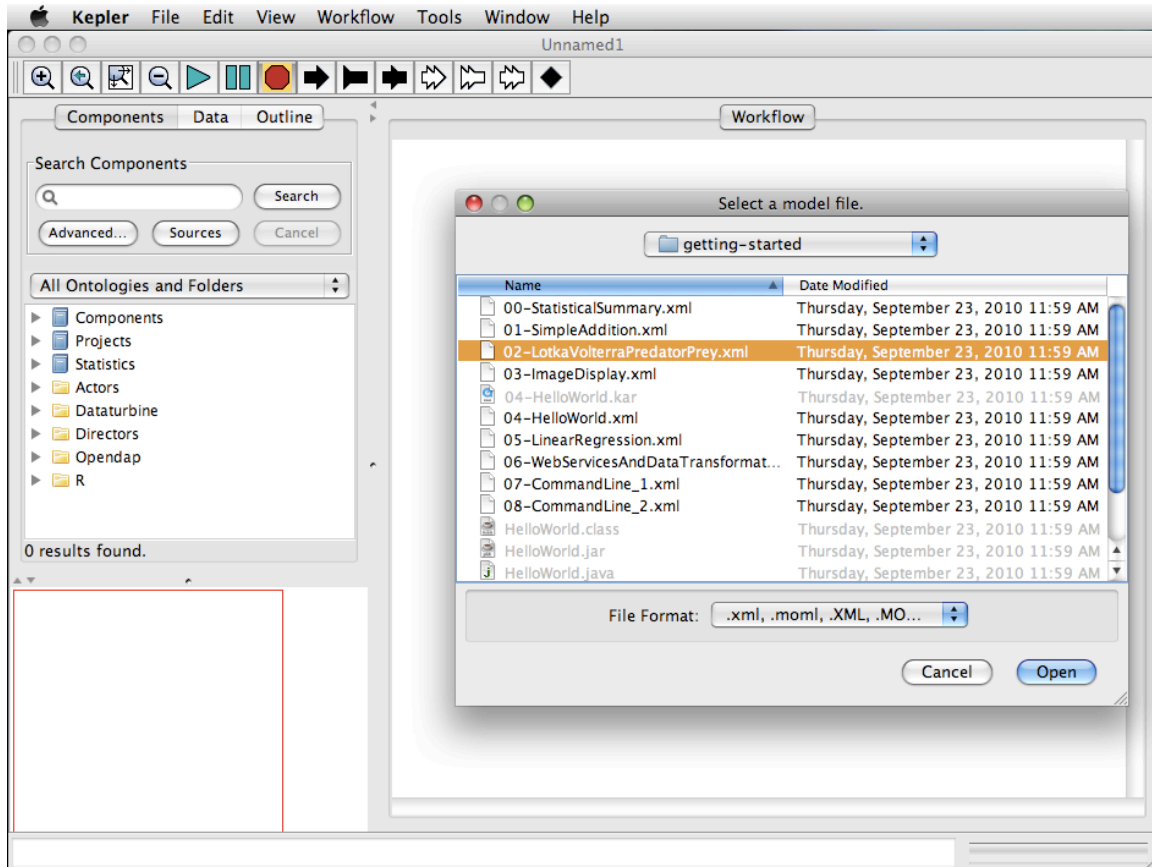

Figure 4.1: Navigating to the Lotka-Volterra workflow. The workflow is in the “demos/getting-started” directory.

3. Double-click the “02-LotkaVolterraPredatorPrey.xml” file. The Lotka-Volterra workflow appears on the Workflow canvas (*Figure 4.2*).

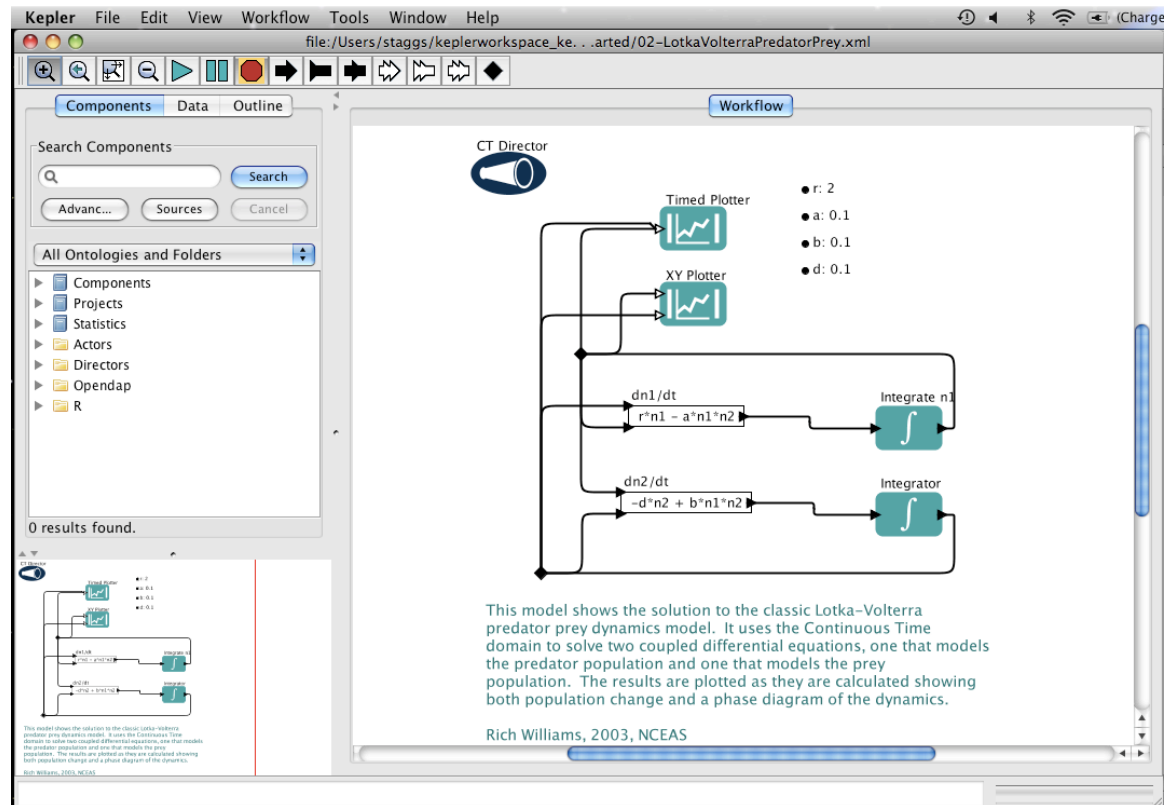

Figure 4.2: The Lotka-Volterra workflow in the Kepler interface.

4.1.2 Opening Remote Workflows

Workflows are often saved and shared via the Web, where they can be easily accessed by the Kepler application or viewed with a Web browser, which will display the XML code in which the workflow is stored.

The simplest way to open a remote workflow stored on a Web server is via Kepler's File > Open MoML URL menu item (Figure 4.3). Select this menu item to open a dialog window which accepts the URL of a remote workflow. Click OK to open the remote workflow on the Workflow canvas.

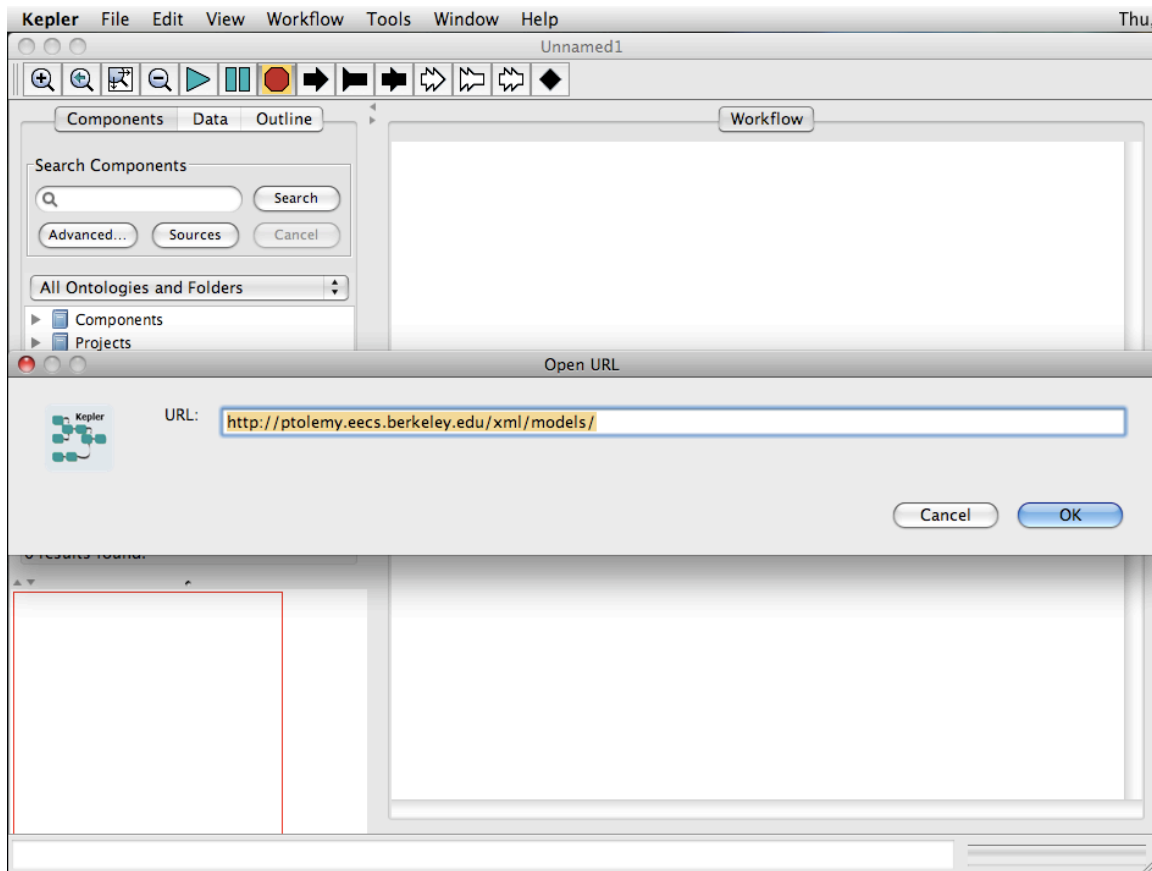

Figure 4.3: Opening a remote workflow saved to a Web server.

Users can navigate to a workflow via the Open MoML URL menu item as well. For example, the URL of a Web page that contains links to a library of workflows can be specified in the Open URL dialog window. Kepler will open the Web page in a browser window, allowing users to view the links and access each workflow by clicking on the appropriate link.

When accessing remote workflows, keep in mind that the local Kepler application may not have all of the components required to run the workflow installed. In this case, errors will be generated when the workflow is opened. Please note that the errors may not clearly indicate the exact problem (i.e., the application does not explicitly generate a list of missing components). To install any necessary components, simply search for them in the Kepler repository and download them by dragging them onto the Workflow canvas. To search the Kepler repository, select the "Search repository" checkbox in the Components tab and type in the name of the required component. See Section 4.5.3 for more information.

4.2 Running Workflows

Workflows can be run in one of two ways: via the Run button in the Toolbar, or via the Workflow menu's Runtime Window menu item.

4.2.1 Runtime Window

Selecting the Runtime Window menu item (*Figure 4.4*) opens a handy window that can be used to start, pause, resume, and stop workflow execution. The window also displays all workflow and director parameters so that they can be viewed and/or edited. Workflow output is displayed in the window once the workflow has executed.

To run a workflow using the Runtime Window:

1. Open the desired workflow.
2. From the Menu bar, select Workflow, then Runtime Window. A Runtime window opens. Workflow and director parameters are displayed on the left side of the window, where they can be adjusted as needed.
3. Click the Go button to start running the workflow.
4. The workflow will execute. During workflow execution, you may select the Pause, Resume, or Stop buttons.

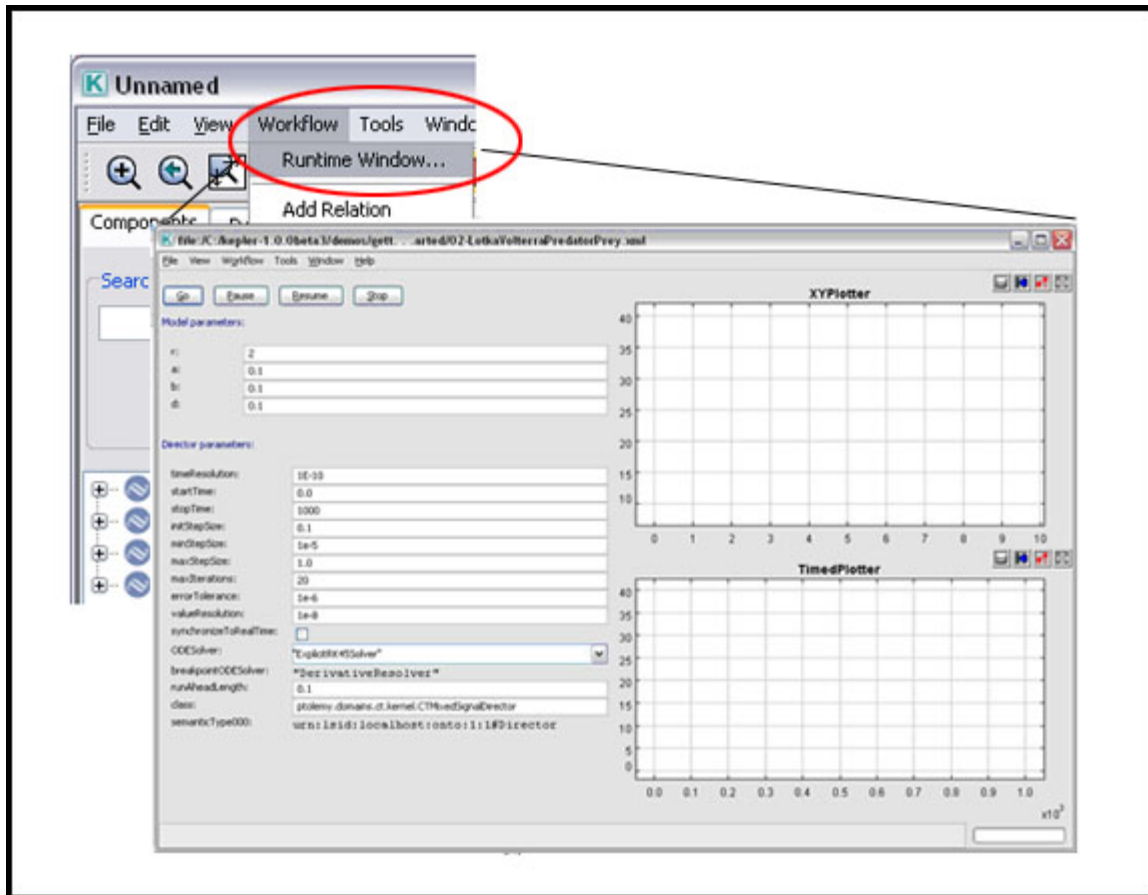

Figure 4.4: Opening the Runtime Window to run a workflow and/or adjust workflow parameters. In this example, the Runtime window is displaying the Lotka-Volterra workflow.

To run the Lotka-Volterra workflow via the Runtime Window:

1. Open the workflow file named “02-LotkaVolterraPredatorPrey” from the “demos/getting-started/” directory.
2. From the Menu bar, select Runtime Window from the Workflow menu. A Runtime Window opens.
3. Click the Go button in the Runtime Window.
4. The Lotka-Volterra workflow will execute with the default parameters and produce two graphs, which are displayed in the window. The graph labeled TimedPlotter depicts the interaction of predator and prey over time (i.e., the cyclical changes of the predator and prey populations over time predicted by the model). The graph labeled XYPlotter depicts a phase portrait of the population cycle (i.e., the predator population against the prey population). Together these graphs show how the predator and prey populations are linked: as prey increases, the number of predators increase. (Figure 4.5)

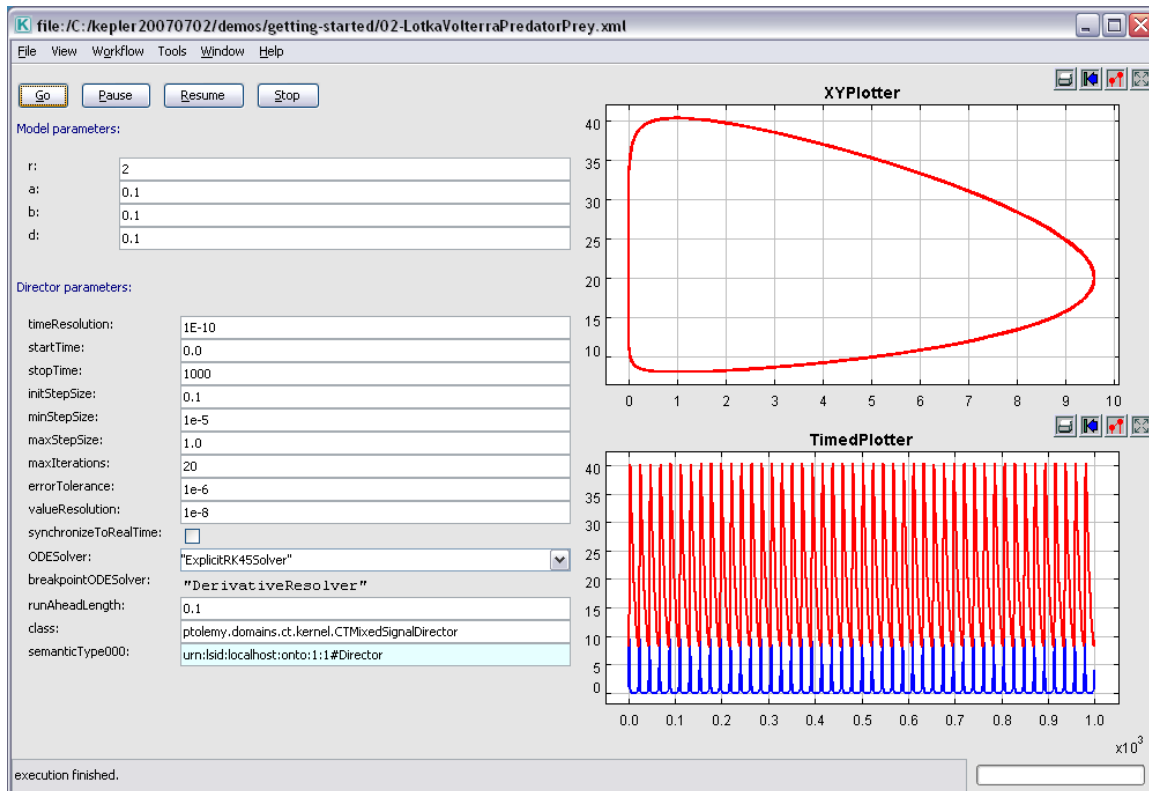



Figure 4.5: The Runtime Window displaying the results output by the Lotka-Volterra workflow.

4.2.2 Run Button

The Run button in the Toolbar runs a workflow with a single button click. Workflow and director parameters are not exposed for editing as they are in the Runtime Window.

To run a workflow using the Run Toolbar button:

1. Open the desired workflow.
2. From the Toolbar, select the Run button. ()
3. The workflow will execute and produce the specified output.

To run the Lotka-Volterra workflow via the Run button

5. Open the workflow file named “02-LotkaVolterraPredatorPrey” from the “demos/getting-started/” directory.
6. On the Toolbar, click the Run button.
7. The Lotka-Volterra workflow will execute with the default parameters and produce two graphs. The graph labeled TimedPlotter depicts the interaction of predator and prey over time (i.e., the cyclical changes of the predator and prey populations over time predicted by the model). The graph labeled XYPlotter depicts a phase portrait of the population cycle (i.e., the predator population against the prey population). Together these graphs show how the predator and

prey populations are linked: as prey increases, the number of predators increase.
(Figure 4.6)

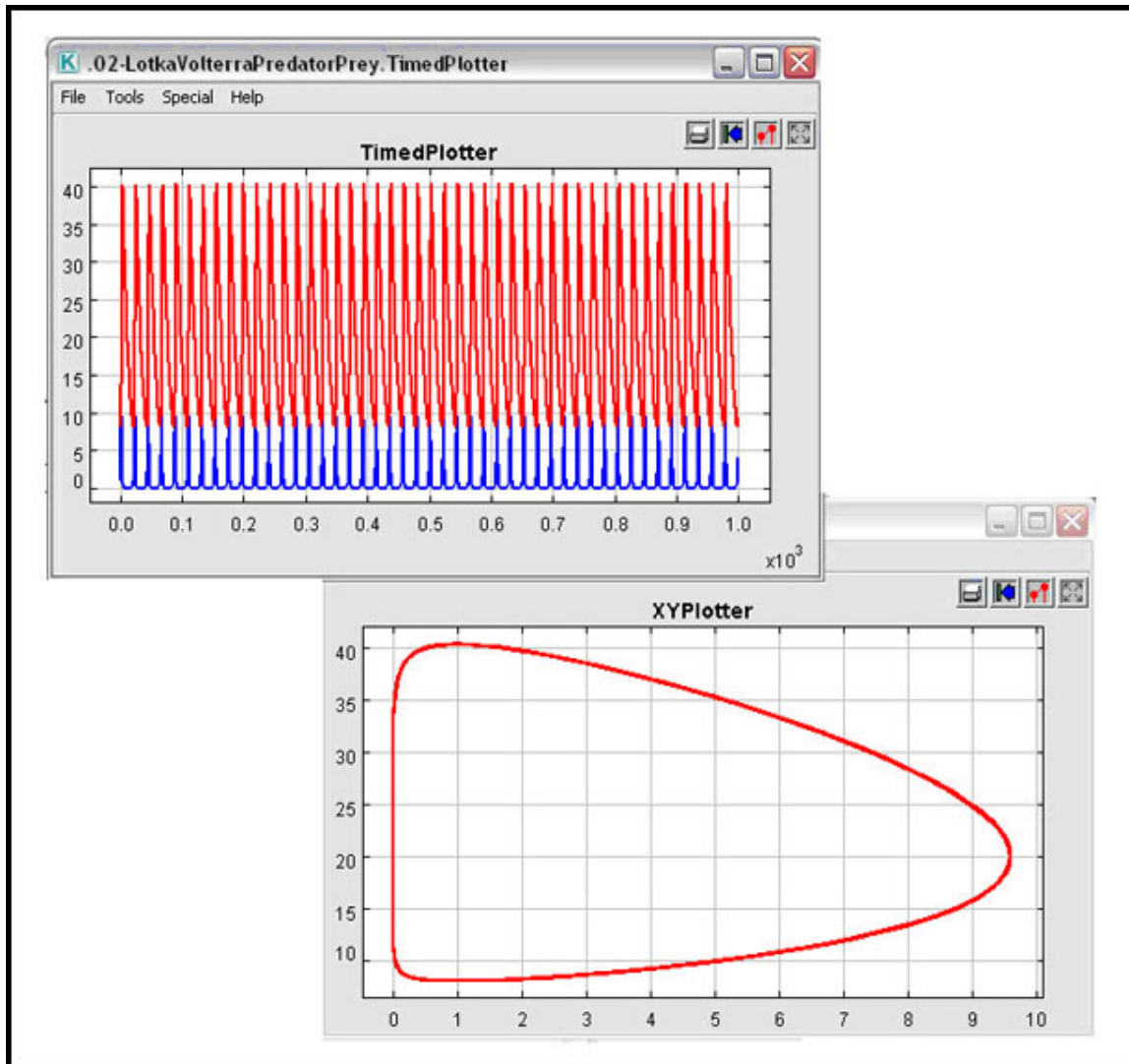

Figure 4.6: Graphs output by the Lotka-Volterra workflow run via the Run button on the Toolbar.

4.2.3 Running Workflows with Adjusted Parameters

Workflow parameters are used to specify anything from the name of a data directory used by a workflow, to the relationship between items processed by the workflow, to the name applied to a workflow's output file. Adjusting these parameters can have a significant effect on the output.

Parameters can be adjusted in one of several ways. Double-click any workflow parameters that appear on the Workflow canvas (e.g., r , a , b , or d in Figure 4.7) to edit the parameter value. Director and actor parameters can be modified by double-clicking

the component and editing the values in the dialog window. If the workflow is run via the Workflow menu's Runtime Window menu item, both workflow and director parameters are exposed and can be edited in the Runtime Window interface before the workflow is run.

In this section, we will step through the process of adjusting the parameters of the Lotka-Volterra workflow to show how adjusting parameters affects workflow output.

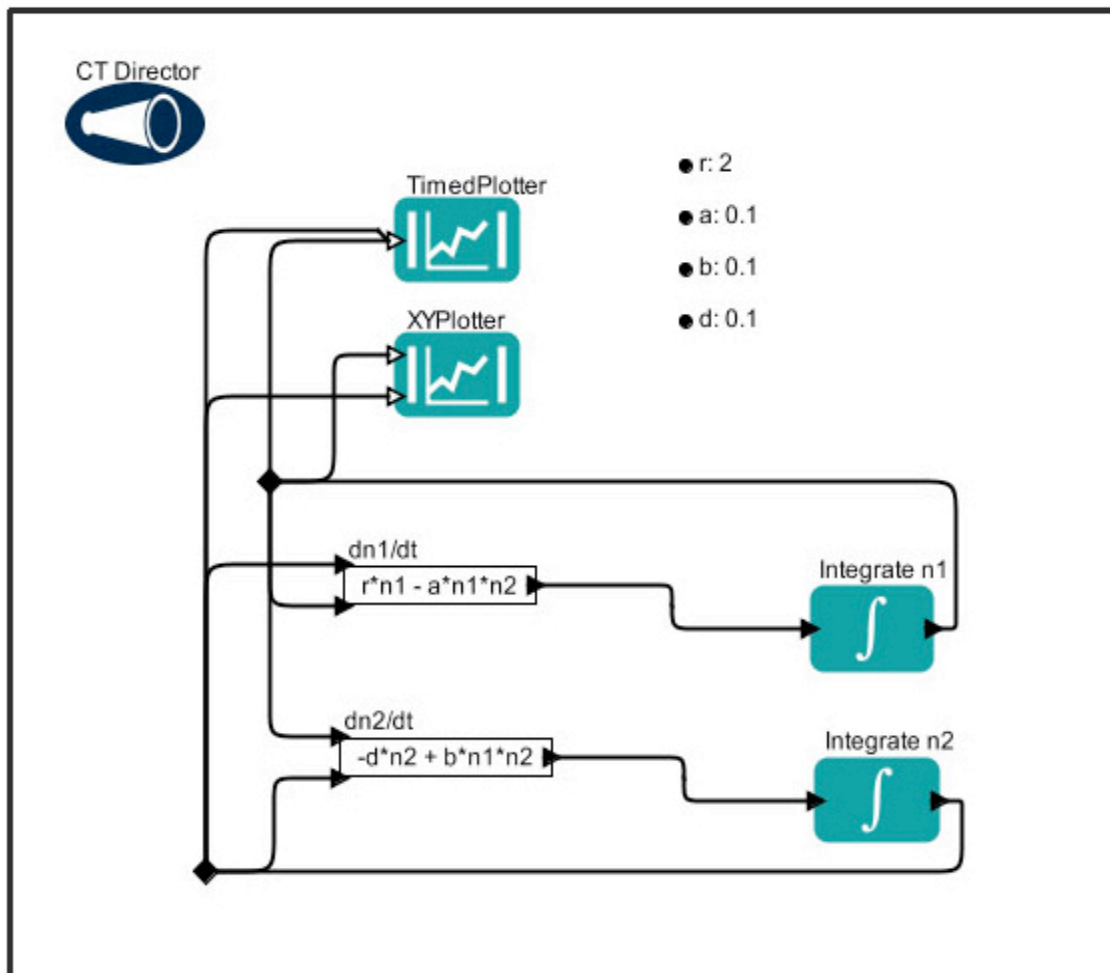

Figure 4.7: The Lotka-Volterra workflow.

The Lotka-Volterra model was developed independently by Lotka (1925)¹¹ and Volterra (1926)¹² and is made up of two differential equations. One equation describes how the prey population changes ($dn1/dt = r \cdot n1 - a \cdot n1 \cdot n2$), and the other describes how the predator population changes ($dn2/dt = -d \cdot n2 + b \cdot n1 \cdot n2$).

¹¹ Lotka, Alfred J (1925). Elements of physical biology. Baltimore: Williams & Williams Co.

¹² Volterra, Vito (1926) Fluctuations in the abundance of a species considered mathematically. Nature 118. 558-560.

The Lotka-Volterra model is based on certain assumptions:

- the prey has unlimited resources;
- the prey's only threat is the predator;
- the predator is a specialist (i.e., the predator's only food supply is the prey); and
- the predator's growth depends on the prey it catches

The Lotka-Volterra model is represented in Kepler as a scientific workflow that contains:

- six actors - two plotters, two equations, and two integral functions;
- one director; and
- four workflow parameters (*Table 4.1*).

NOTE: The director of the Lotka-Volterra model has several configurable parameters as do the two plotter actors.

The critical assumptions above provide the basis for the workflow parameters. The workflow parameters and their defaults are as follows:

Parameter	Default Value	Description
r	2	the intrinsic rate of growth of prey in the absence of predation
a	0.1	capture efficiency of a predator or death rate of prey due to predation
b	0.1	proportion of consumed prey biomass converted into predator biomass (i.e., efficiency of turning prey into new predators)
d	0.1	death rate of the predator

Table 4.1: Description of the default parameters for the Lotka-Volterra workflow

In the differential equations used in the workflow, ($dn_1/dt = r*n_1 - a*n_1*n_2$) and ($dn_2/dt = -d*n_2 + b*n_1*n_2$), the variable n_1 represents prey density, and the variable n_2 represents predator density.

When changing parameters in a workflow, the assumptions of the model must be kept in mind. For example, if creating a Lotka-Volterra model with rabbits as prey and foxes as predators, the following assumptions can be made with regard to how the rabbit population changes in response to fox population behavior:

- the rabbit population grows exponentially unless it is controlled by a predator;
- rabbit mortality is determined by fox predation;
- foxes eat rabbits at a rate proportional to the number of encounters;
- the fox population growth rate is determined by the number of rabbits they eat and their efficiency of converting the eaten rabbits into new baby foxes; and
- fox mortality is determined by natural processes.

If you think of each run of the model in terms of the rates at which these processes would occur, then you can think of changing the parameters in terms of percent of change over time.

To run the Lotka-Volterra workflow with adjusted parameters:

1. Open the workflow file named “02-LotkaVolterraPredatorPrey” from the “demos/getting-started” directory
2. From the Menu bar, select Runtime Window from the Workflow menu. The Runtime window opens. Notice there are two sets of parameters – one for the workflow and one for the director. For more detail about the director parameters, right-click the director and select Documentation > Display from the drop-down menu. In this example, you will make adjustments to both workflow and director parameters.
3. Adjust the workflow parameters as suggested in *Table 4.2*.

Parameter	New value	Description
r	0.04	the intrinsic rate of growth of prey in the absence of predation
a	0.0005	capture efficiency of a predator or death rate of prey due to predation
b	0.1	proportion of consumed prey biomass converted into predator biomass (i.e., efficiency of turning prey into new predators)
d	0.2	death rate of the predator

Table 4.2: Description of the suggested parameters for the Lotka-Volterra workflow taken from <http://www.stolaf.edu/people/mckelvey/envision.dir/lotka-volt.html>

4. Adjust the value of the `stopTime` director parameter to 300.
5. In the Runtime window, click the Go button.

The Lotka-Volterra workflow will execute with the adjusted parameters and produce two graphs: 1) the TimedPlotter graph and 2) the XYPlotter graph. Note that with the changes in the parameters, the relationship between the predator and prey populations are still linked but the relationship has changed (*Figure 4.8*).

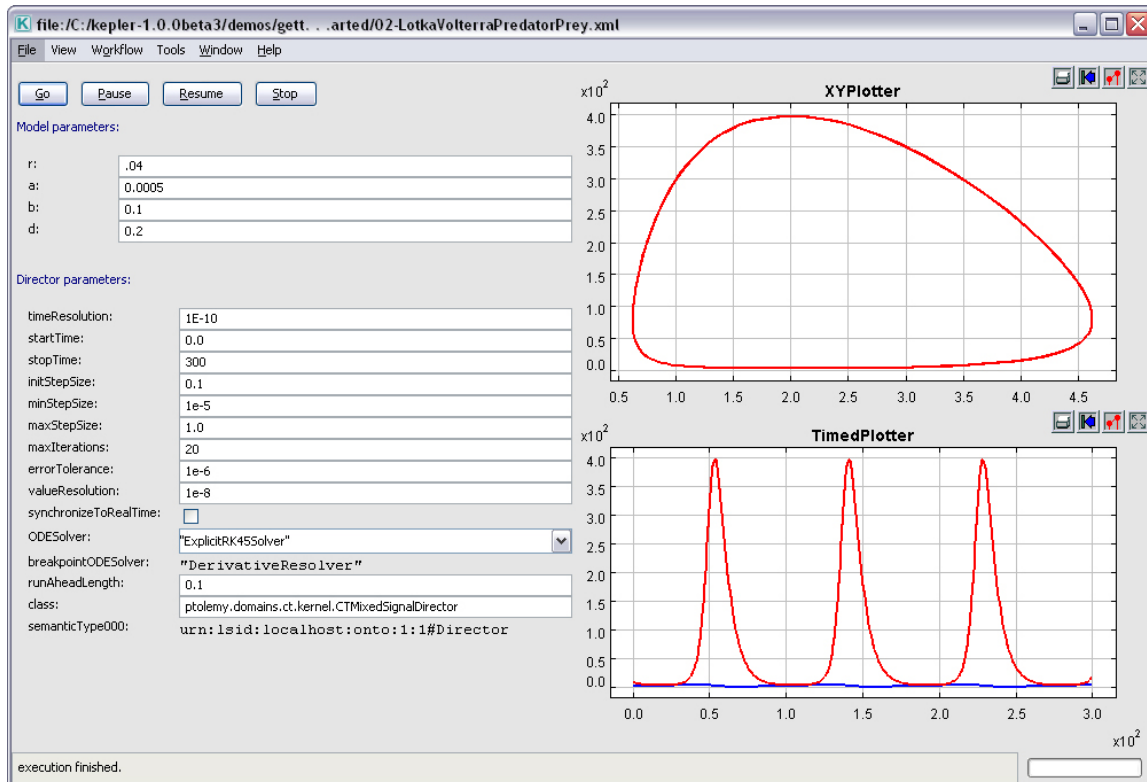

Figure 4.8: Graphs output by the Lotka-Volterra model with adjusted parameters

4.3 Modifying Workflows

There are two basic ways to modify an existing scientific workflow:

- substitute a different data set for the current data set;
- substitute one or more analytical processes in the workflow with other analytical processes (e.g., substitute a neural network model actor for a probabilistic model actor).

In order to be substituted, data sets and processing components must be compatible with the workflow. Workflow documentation should contain information about the type of data and processing that occur in the workflow; if not, you may need to do some investigative research: roll over actor ports to see the name of the port and the type of data it accepts or broadcasts; right-click individual actors and select Documentation to read more about the type of processing it does; or open existing data files used by the workflow to see how they are formatted.

The basic steps involved in modifying a workflow are:

1. Open the desired workflow.

2. Identify which workflow component is the target for substitution.
3. Select the target component (data actor or processing actor) by clicking it. The selected component will be highlighted in a thick yellow border.
4. Press the Delete key on your keyboard. The highlighted component will disappear from the Workflow canvas.
5. From the Components and Data Access area, drag an appropriate data or processing actor to the Workflow canvas.
6. Connect the appropriate input and output ports and customize the actor parameters
7. Run the workflow.

4.3.1 Substituting Data Sets

Substituting data sets involves "pointing" the workflow to a new set of data. For local data, a data set is often specified by an *Expression* or a *StringConstant* actor, which use an expression to generate the location of the data file (see Chapter 8 for more information about the *Expression* actor). Other times, the location of the data set is specified as a workflow or actor parameter. Remote data is often accessed via Kepler data actors that handle all of the mechanical issues associated with parsing the Ecological Metadata Language (EML) that describes the data, downloading the data from remote servers if applicable, understanding the logical structure of the data, and emitting the data for downstream actors to use when required.

In this section, we'll look at how to substitute a local data set into a workflow as well as how to substitute remotely stored data sets that use EML. Before substituting data sets into a workflow, you must ensure that the data are formatted as required by the workflow (e.g., a tab-separated list or a table with metadata) and that the units and data types are compatible.

Substituting a Local Data Set

Kepler can read data in many ways and from many formats. For example, the workflow in *Figure 4.9* uses a *FileReader* actor to access the contents of a data table saved in a text format. A *Display* actor then displays the data in a text window.

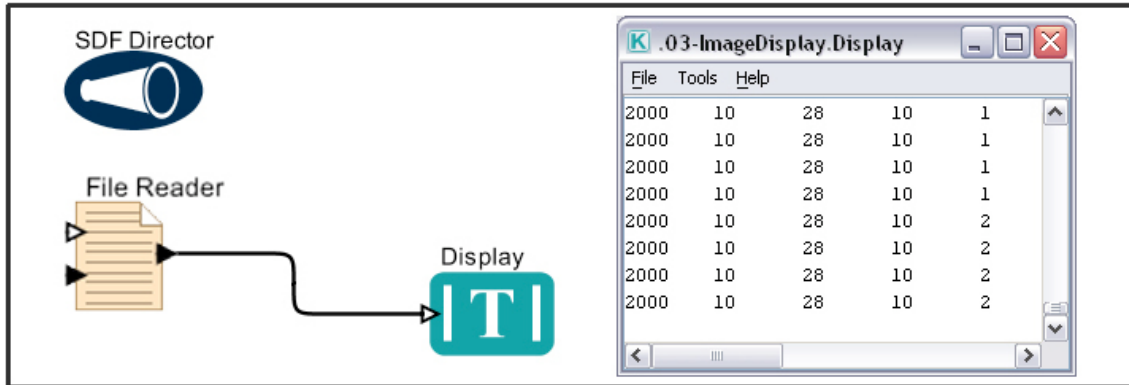

Figure 4.9: Using and displaying local data in a workflow.

The *FileReader* actor opens the local data file specified by the actor's parameters. To substitute another file, simply double-click the *FileReader* actor to expose its parameters, click the Browse button to the right of the actor's `fileOrURL` parameter, and navigate to the desired file (Figure 4.10). Select a file and click the Commit button. The actor is now configured to read the specified file.

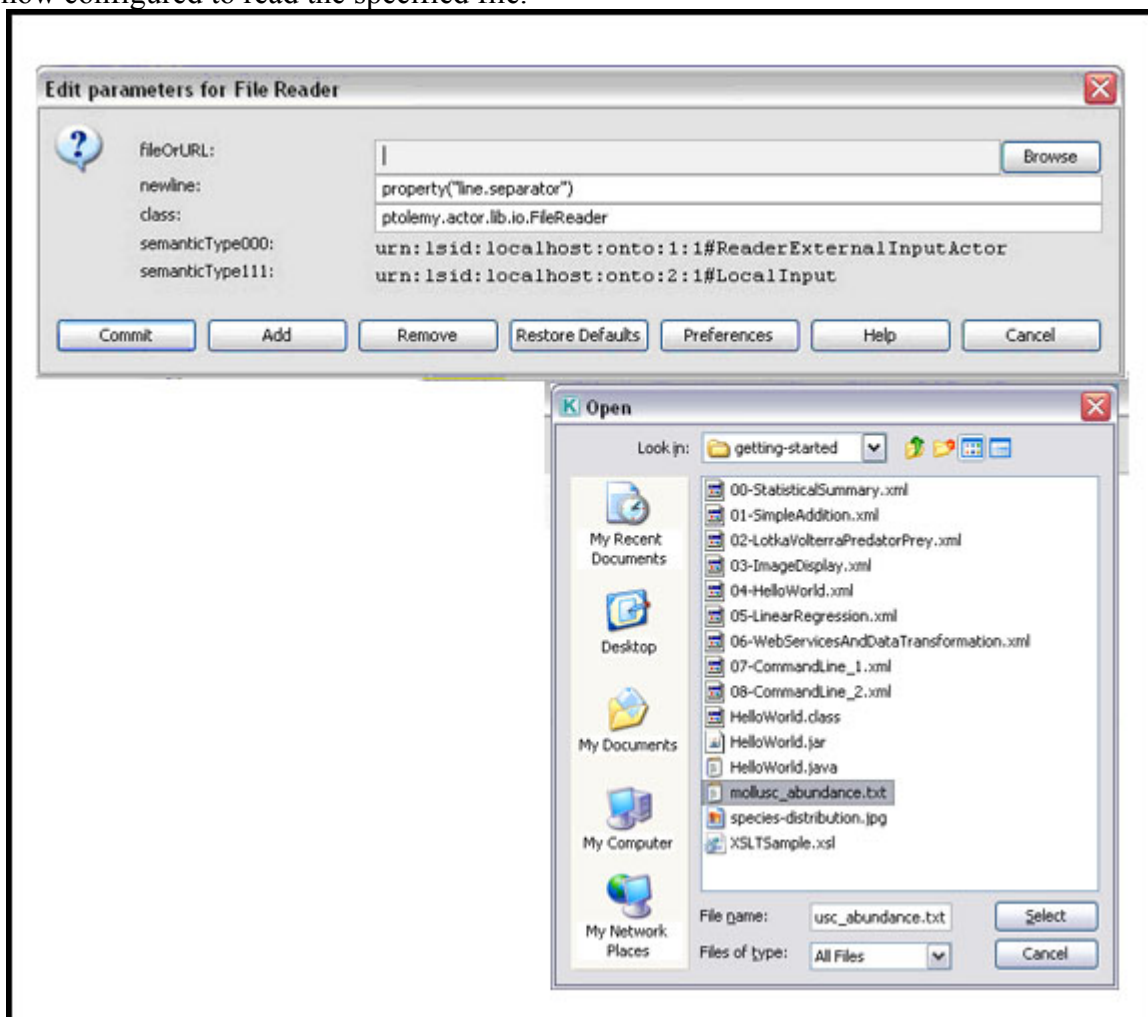

Figure 4.10: Configuring the *FileReader* actor to use data from your local machine.

NOTE: When creating a workflow, remember that the limitations of the data determine which processing components are appropriate.

The ReadTable.xml workflow (*Figure 4.11*), which is included in the KeplerData/workflows/module/r-2.X.Y/demos/R/ directory, is an example of a workflow that reads a local text-based data file containing species occurrence data ("mollusc_abundance.txt"). The workflow extracts the species names from the data set as well as the species count and creates a plot of the data (*Figure 4.12*). See Chapter 8 for more information about R and how this workflow operates. For now, we are only concerned with how the workflow accesses data, and how users can substitute a new data set.

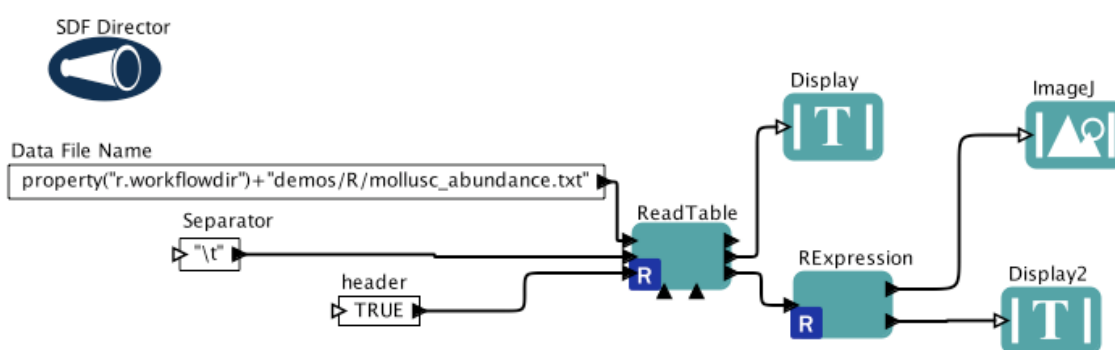

Figure 4.11: The ReadTable.xml workflow.

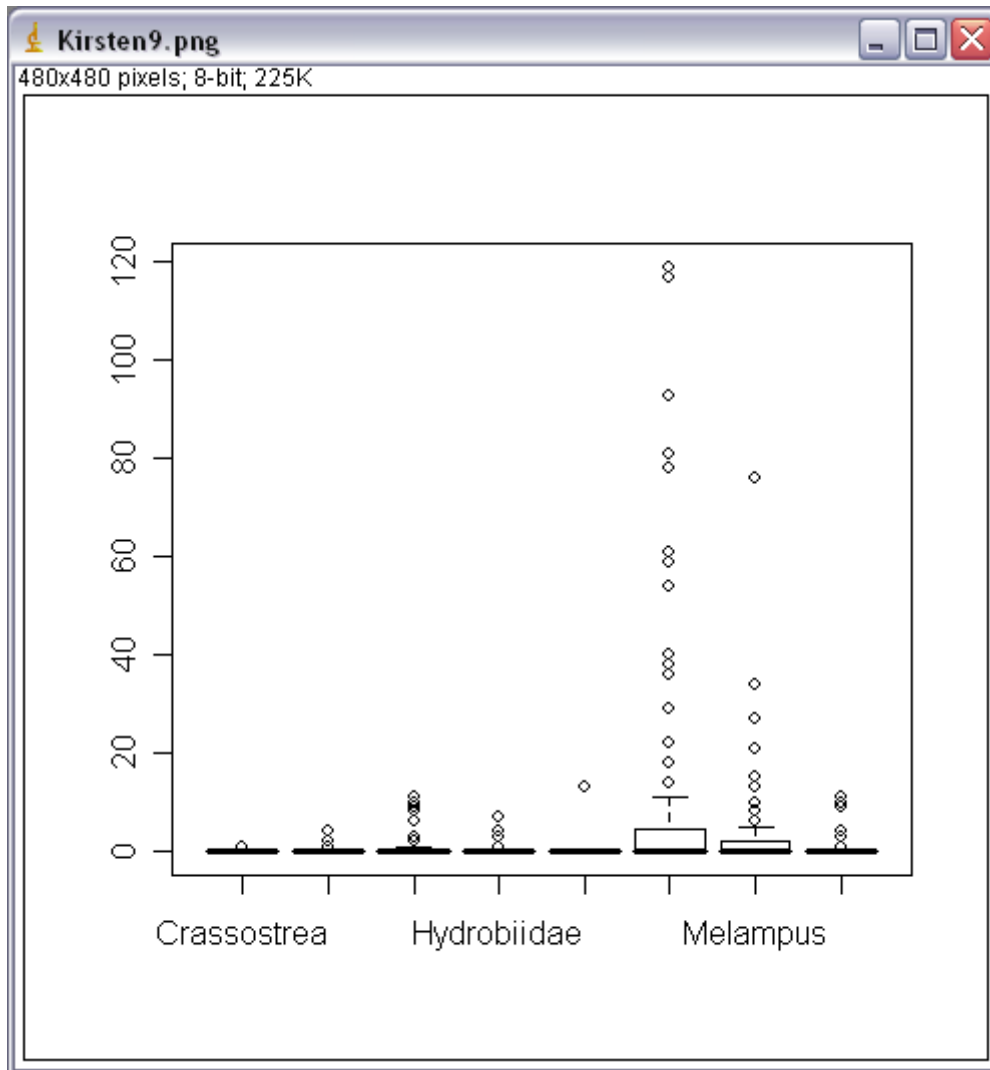

Figure 4.12: Output of the ReadTable.xml workflow. The workflow extracts each species name and occurrence information from the mollusc_abundance.txt data file, and creates a plot of the data.

The workflow uses an *Expression* actor labeled *Data File Name* to reference the data set. The value,

```
property("r.workflowdir")+"demos/R/mollusc_abundance.txt",
```

is an expression written in the Kepler expression language. The expression `property("r.workflowdir")` returns the path to the R module's workflow directory in KeplerData. `"demos/R/mollusc_abundance.txt"` is the rest of the path to this data file.

In this workflow, the input file is a text file containing data in a 'spreadsheet-like' tabular format. Each line of the file contains one row of values, separated by a 'separator' delimiter—a tab ("`\t`"), as specified by the workflow's *Separator* actor. By default, the first row of the data file is assumed to contain the column names. (Setting the value of the *header* actor to `FALSE` will change this default). Saving an Excel spreadsheet as a text file creates such a data file with a tab separator (*Figure 4.13*).

Year	Month	Day	Site	Zone	Plot	Species	Mollusc_Count	Quadrat_Area	Mollusc_Density
2000	10	30	1	1	1	Littoraria	0	0.2500	0
2000	10	30	1	1	3	Littoraria	0	0.2500	0
2000	10	30	1	1	6	Littoraria	0	0.2500	0
2000	10	30	1	1	8	Littoraria	4	0.2500	16
2000	10	30	1	2	1	Littoraria	0	0.2500	0
2000	10	30	1	2	3	Littoraria	0	0.2500	0
2000	10	30	1	2	6	Littoraria	0	0.2500	0
2000	10	30	1	2	8	Littoraria	0	0.2500	0
2000	10	26	2	1	1	Littoraria	3	0.5000	6
2000	10	26	2	1	3	Littoraria	1	0.5000	2
2000	10	26	2	1	6	Littoraria	1	0.5000	2
2000	10	26	2	1	8	Littoraria	0	0.5000	0
2000	10	26	2	2	1	Littoraria	0	0.5000	0
2000	10	26	2	2	3	Littoraria	0	0.5000	0
2000	10	26	2	2	6	Littoraria	0	0.5000	0
2000	10	26	2	2	8	Littoraria	0	0.5000	0
2000	10	28	3	1	1	Littoraria	2	0.2500	8
2000	10	28	3	1	3	Littoraria	1	0.2500	4
2000	10	28	3	1	6	Littoraria	0	0.2500	0
2000	10	28	3	1	8	Littoraria	0	0.0625	0
2000	10	28	3	2	1	Littoraria	54	0.5000	108
2000	10	28	3	2	3	Littoraria	119	0.2500	476
2000	10	28	3	2	6	Littoraria	117	0.2500	468
2000	10	28	3	2	8	Littoraria	117	0.2500	468

Figure 4.13: The mollusc_abundance.txt data set used by the ReadTable.xml workflow. Data is contained in columns separated by a tab delimiter.

To use another set of data, simply ensure that the data are formatted correctly, and substitute the name of the new data set into the *Data File Name* actor.

Substituting Remote Datasets Via the EarthGrid

Substituting data sets that are stored remotely on the EarthGrid is another simple way to edit a workflow. For example, the workflow displayed in *Figure 4.14* reads an Intergovernmental Panel on Climate Change (IPCC) data set containing cloud cover data that are stored on the EarthGrid. This dataset uses EML metadata to describe the data, and can therefore be downloaded and accessed with the *EML2Dataset* actor (named *IPCC Climate Change Data: 1961-1990, Cloud Cover* in the example workflow).

The workflow converts the data to a new format (see the documentation for the *ClimateFileProcessor* actor for more information) and saves it.

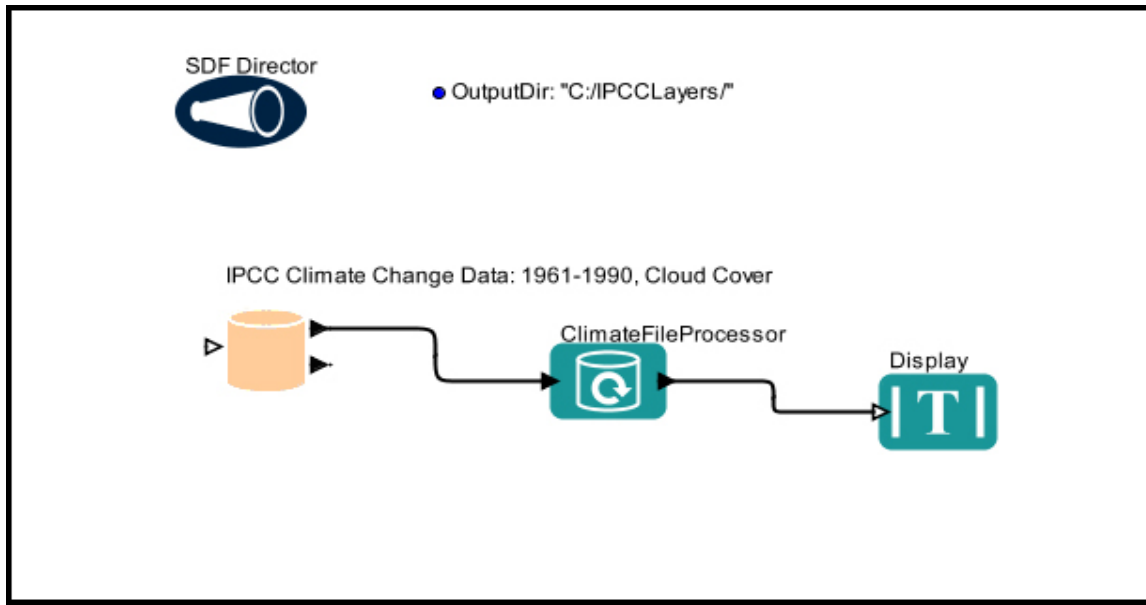

Figure 4.14: The example workflow processes an IPCC data set stored and accessed from the EarthGrid. The data are described using Ecological Metadata Language (EML).

To use the workflow to convert other data (rainfall, wind, temperature, etc), simply navigate to Kepler's Data tab and search for IPCC (*Figure 4.15*). Kepler will locate other IPCC data sets, which will be displayed in the Data tab. Dragging and dropping any EML data set onto the Workflow canvas instantiates an *EML2Dataset* actor, which downloads the data so that it can be used by the workflow. The *EML2Dataset* actor will automatically configure itself to provide one port for each attribute described by the EML description. For example, if the data consist of four columns, the ports might be "Site", "Date", "Plot", and "Rainfall."

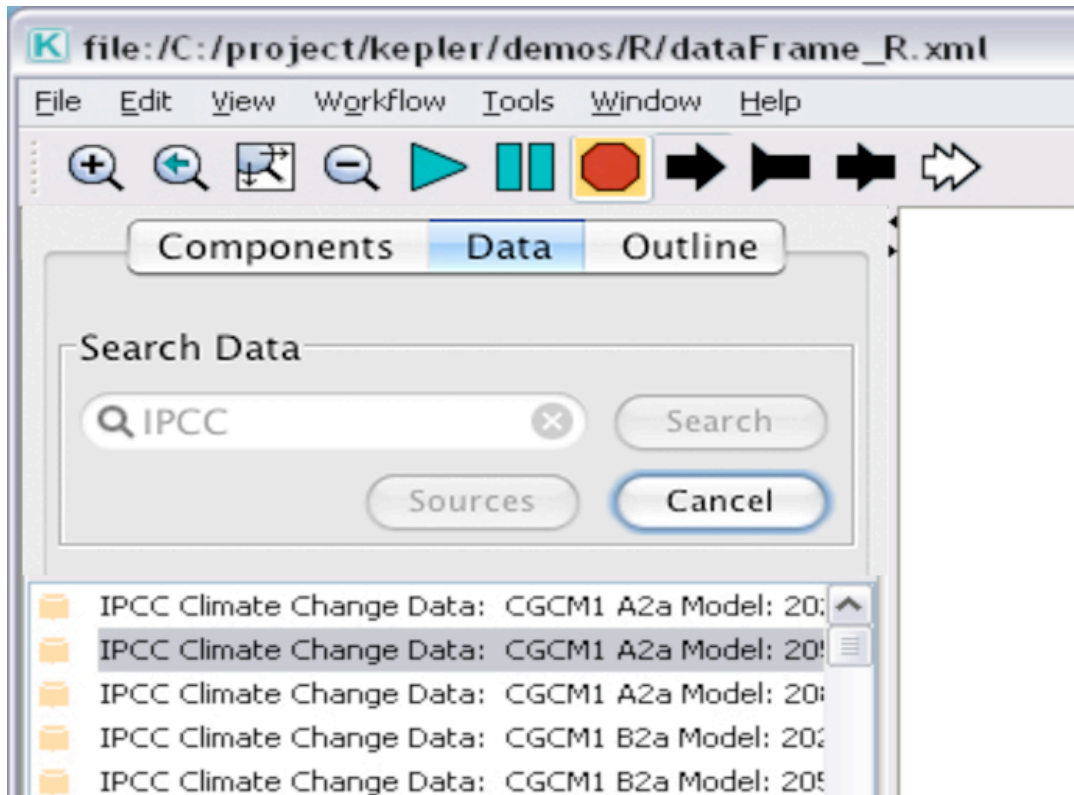

Figure 4.15: Searching for IPCC climate data sets stored on the EarthGrid.

The example workflow can be used to convert any historical IPCC data set. Future climate change data require a *ClimateChangeFileProcessor* actor instead of the *ClimateFileProcessor* actor.

Note that the *EML2Dataset* actor can be configured to output the data in one of a variety of different formats. In the example, the *EML2Dataset* actor has been configured to output data "As Cache File Name." To configure a data actor, double-click it and select the appropriate data output format (*Figure 4.16*).

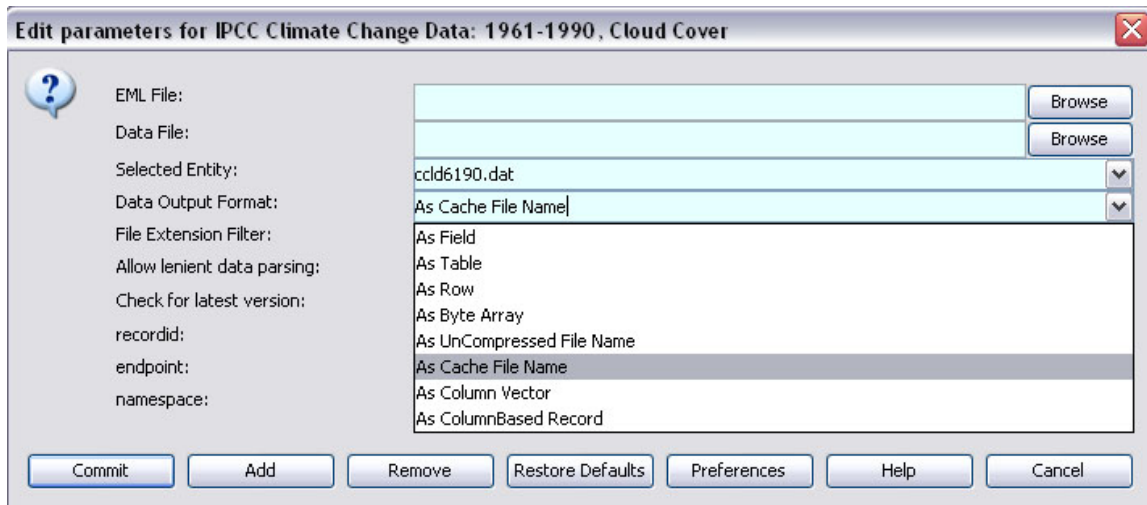

Figure 4.16: Customizing the data output format of the data actor.

For more information about data output formats, please see Chapter 6.

4.3.2 Substituting Analytical Components

Kepler comes with hundreds of ready-to-use components that can be plugged into existing workflows to customize the workflow processing. Data can be converted into a variety of different formats or displayed in different ways. In this section, we will look at how to change the way a workflow displays its output by substituting one kind of display actor for another.

The Image Display workflow found under “demos/getting-started/03-ImageDisplay.xml” (*Figure 4.17*) converts an image—a bitmapped image representing the species distribution of the species *Mephitis*, a skunk, throughout North and South America—and then displays the image using an *ImageJ* actor, which uses the ImageJ application to open and work with a wide variety of images (tiffs, gifs, jpegs, etc.) For more information about ImageJ, see Chapter 8.

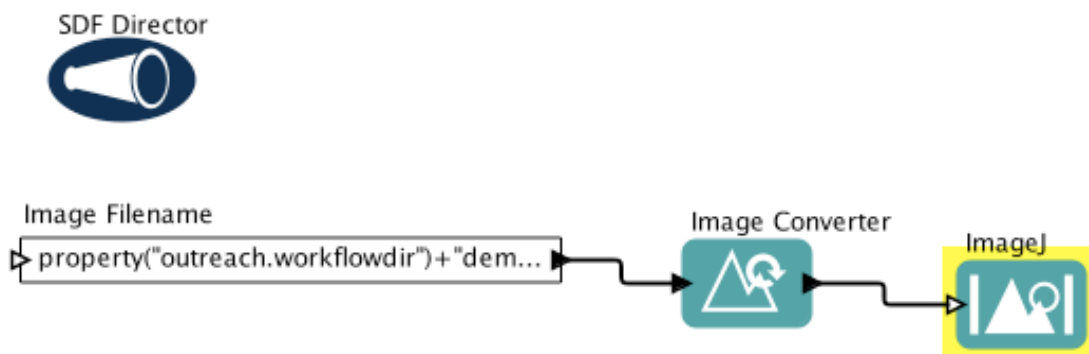

Figure 4.17: The Image Display workflow. The *ImageJ* actor is highlighted.

The Image Display workflow converts the specified image, a jpeg file, to a png format and then displays it (*Figure 4.18*). The actor also opens the ImageJ application, which can be used to modify the image via a handy toolbar (*Figure 4.19*).

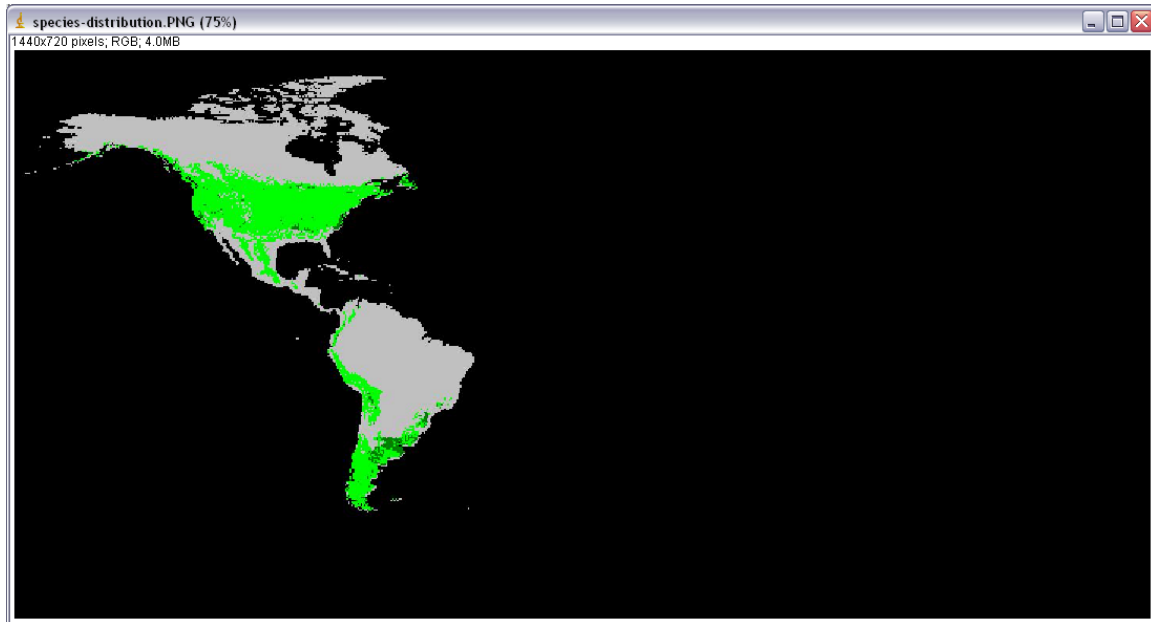

Figure 4.18: The output of the ImageJ actor. The image was originally created by GARP, a genetic algorithm that creates an ecological niche model for a species that represents the environmental conditions where that species would be able to maintain populations. GARP was originally developed by David Stockwell, at the [San Diego Supercomputer Center](http://www.lifemapper.org/desktopgarp/). For more information on GARP, see <http://www.lifemapper.org/desktopgarp/>.

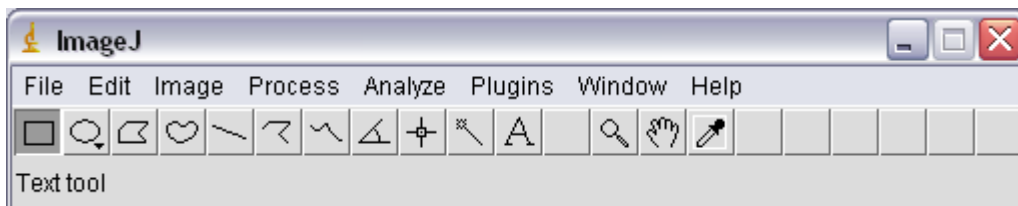

Figure 4.19: The ImageJ toolbar that permits users to modify the image.

Rather than using ImageJ to display the workflow output, you may wish to use a simple browser interface. To do so requires a single actor substitution—swapping a *BrowserDisplay* actor for the *ImageJ* one. To make the substitution:

1. Open the 03-Image-Display.xml workflow from the “demos/getting-started/” directory.
2. Select the target component, the *ImageJ* actor in this case. The *ImageJ* actor will be highlighted in a thick yellow border, indicating that it is selected.
3. Press the Delete key on your keyboard. The *ImageJ* actor will disappear from the Workflow canvas.

4. From the Components and Data Access area, drag the *Browser Display* actor to the Workflow canvas. You can find the *Browser Display* actor in the Components tab under “Components > Data Output > Workflow Output > Textual Output.”
5. Connect the output port of the *Image Converter* actor to the input port of the *Browser Display* actor. To connect the ports, left-click and hold the output port (black triangle) on the right side of the *Image Converter* actor, drag the pointer to the upper input port on the left side of the *Browser Display* actor, and then release the mouse. If the connection is made, you will see a thick black line (*Figure 4.20*). If the connection is not completely made, the line will be thin.
6. Run the workflow. Note that the image is now displayed in a browser window (*Figure 4.21*).

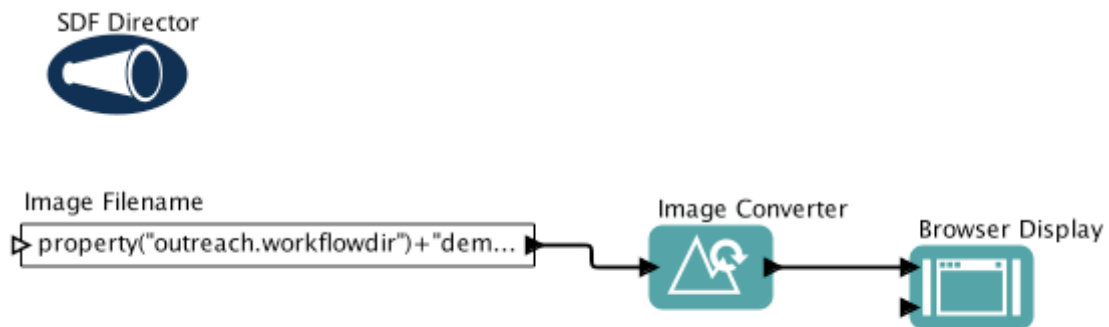

Figure 4.20: The Image Display workflow with the *Browser Display* actor substituted for the *ImageJ* actor.

NOTE: Sometimes the easiest way to connect actors is to go from the output port of the source to the input port of the destination.

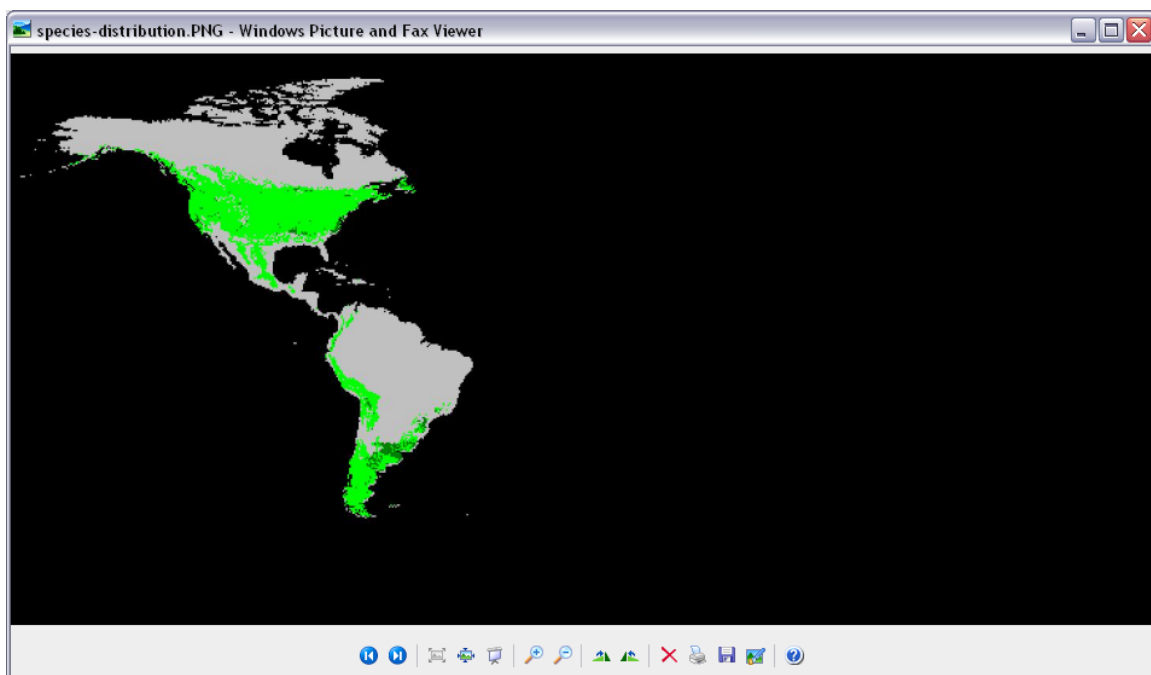

Figure 4.21: The image displayed by the *Browser Display* actor.

4.4 Saving Workflows

Workflows are saved in KAR or XML format, which can be easily stored and shared. To save a workflow, select the Save, Save As, or Export... menu item from the File menu, then name the file and select a save location.

For instructions on saving a workflow and sharing it with others, see Section 5.9 [Saving and Sharing Workflows](#).

4.5 Searching for Data and Components

Kepler provides a searching mechanism to locate data (on the EarthGrid) and analytical processing components (on the local system as well as the remote Kepler repository).

4.5.1 Searching for Available Data

Via its search capabilities, Kepler provides access to data that is stored on the EarthGrid. EarthGrid resources are stored in the [KNB Metacat](#) and the [KU Digir](#) databases. For more information about the EarthGrid, see Chapter 2.

To search for data on the EarthGrid:

6. In the Components and Data Access area, select the Data tab (*Figure 4.22*).
7. Type in the desired search string (e.g., *Datos Meteorologicos*). Make sure that the search string is spelled correctly. You can also enter just part of the entire string – e.g. ‘*Datos*’.
8. To configure the search, click the Sources button (make sure the Data tab is selected). Selecting the sources to be searched and the type of documents to be retrieved can help streamline the search and reduce the amount of time required to return results. For example, because *Datos Meteorologicos* is stored in the KNB Metacat database, the data source for the search can be limited to just that node on the grid. In the Source dialog window, uncheck “KNB Metacat Authenticated Query Interface” and click OK.
9. Click the Search button. Results may take 20 seconds to return. A status bar at the bottom of the Data tab scrolls until the search is complete. When the search is complete, a list of search results will be displayed in the Components and Data Access area. The number of returned results is displayed in the status area.
10. To use one or more data actors in a workflow, simply drag the desired data set to the Workflow canvas.

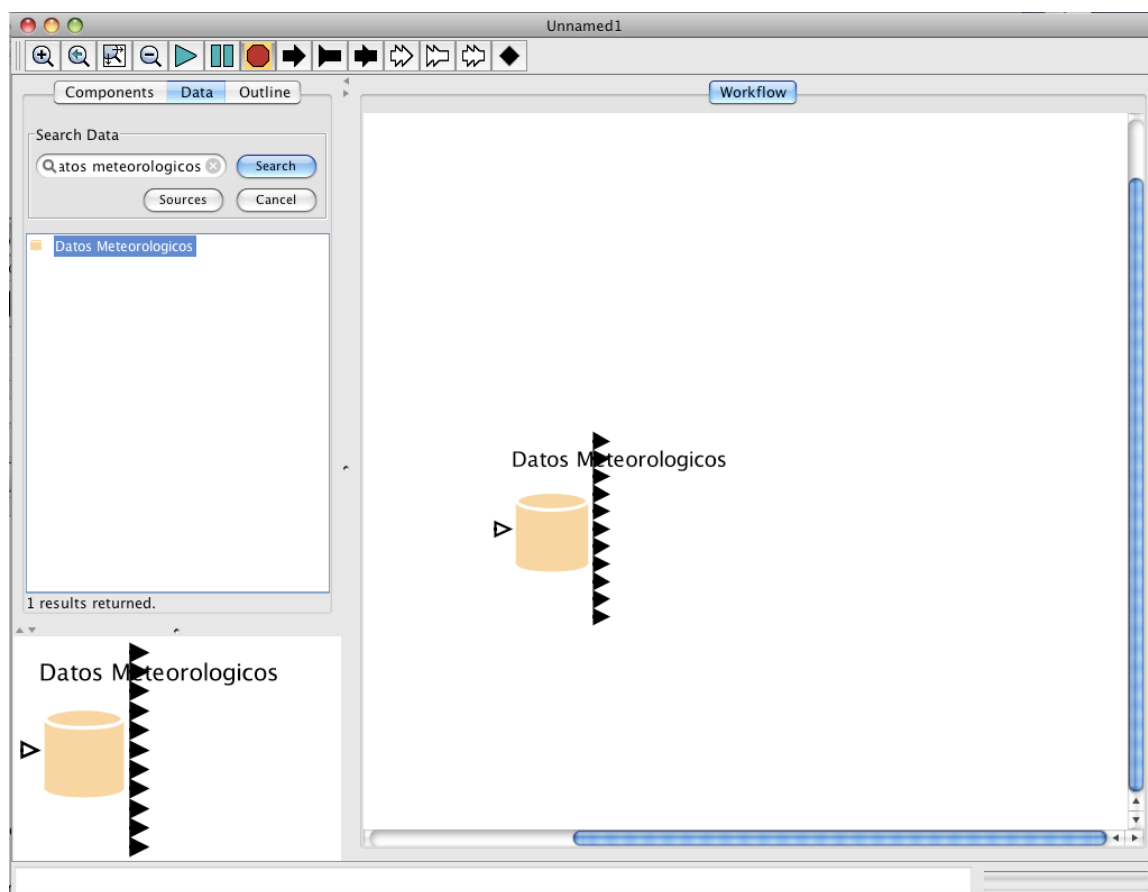

Figure 4.22: Searching for and locating *Datos Meteorologicos*, a data set that is stored on the EarthGrid

For more information about the data set, right-click *Datos Meteorologicos* in the Components and Data Access area or on the Workflow canvas and select Get Metadata (Figure 4.23). Depending upon the amount of information entered by the provider, much valuable metadata can be obtained. For example, the type of value and measurement type of each attribute help you decide which statistical models are appropriate to run.

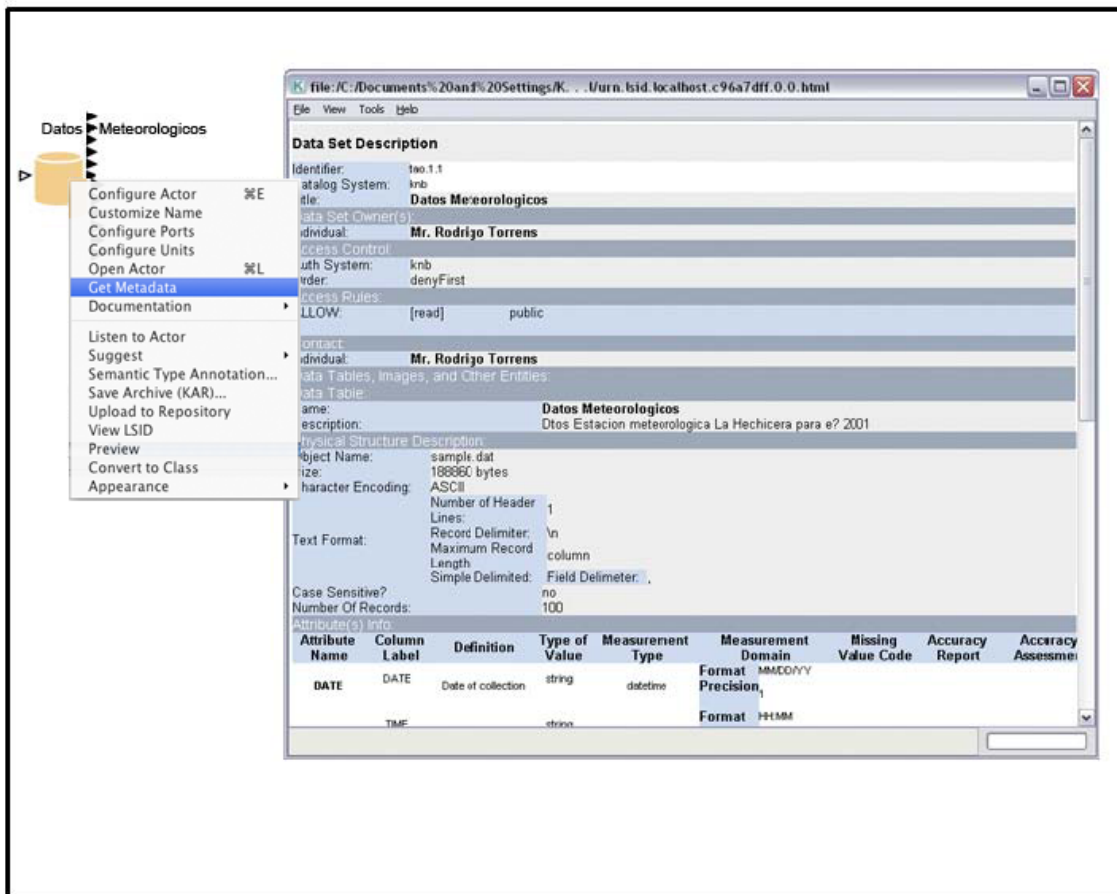

Figure 4.23: Viewing Metadata

The data actor will automatically configure its output ports to match the data. Mouse over the data ports to reveal a port tooltip (Figure 4.24). The tooltip contains the name of the port/data field as well as the data type.

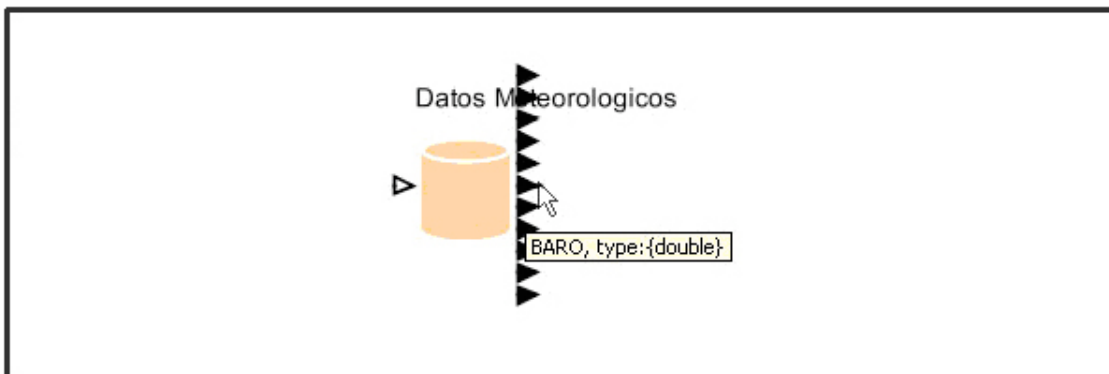

Figure 4.24: Identifying data ports. Mouse-over each output port to reveal the port tooltip.

You can also preview the data set by right-clicking the actor and selecting Preview from the drop-down menu (Figure 4.25).

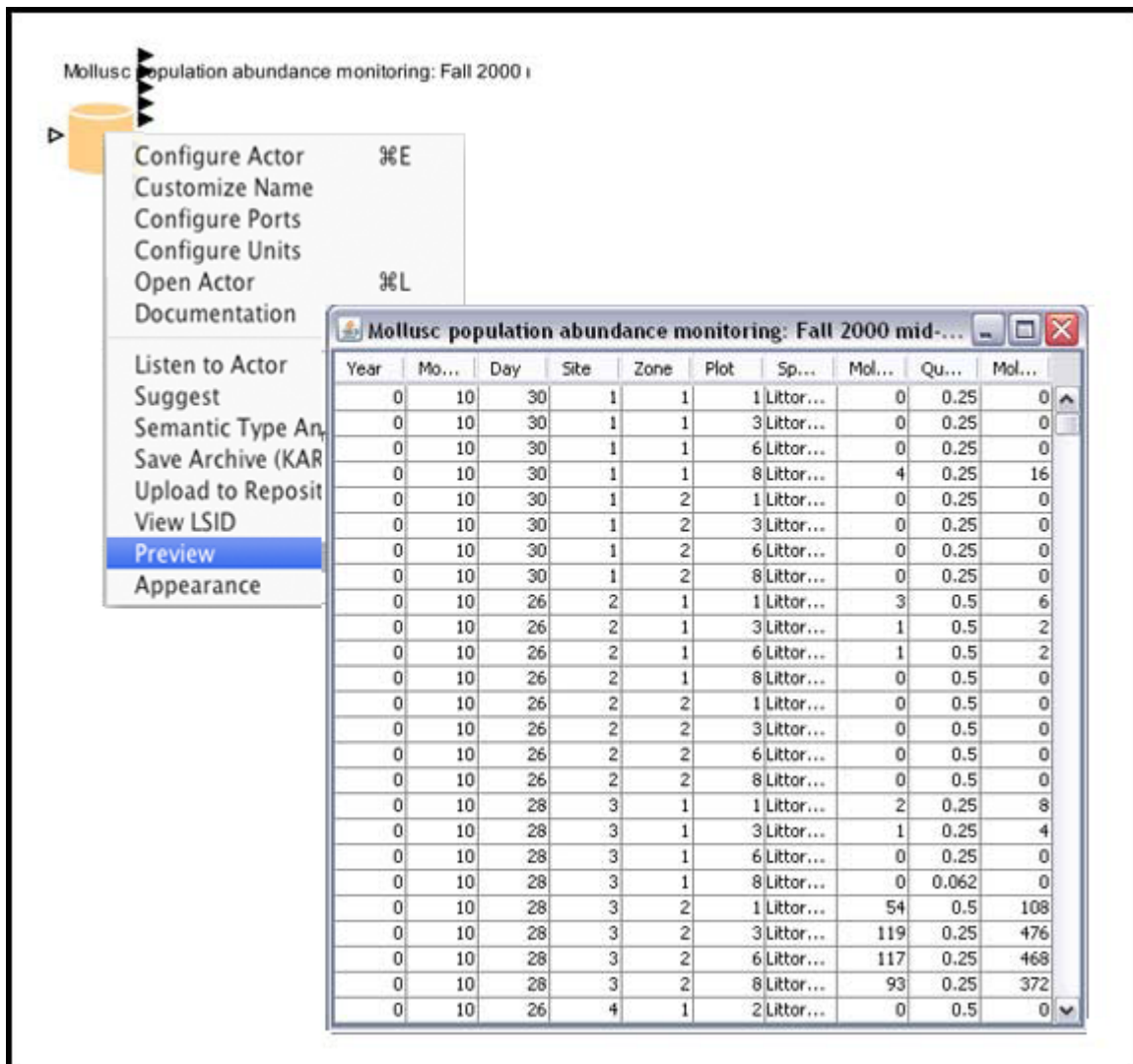

Figure 4.25: Previewing the Datos Meteorologicos data set.

4.5.2 Searching for Standard Components

Kepler comes standard with over 350 workflow components and the ability to modify and create your own. Users can create an innumerable number of workflows with a variety of analytic functions. The default set of Kepler processing components is displayed under the Components tab in the Components and Data Access area. Components are organized by function (e.g., “Director” or “Filter Actor”). To search for processing components:

6. In the Components and Data Access area to the left of the Workflow canvas, select the Components tab.
7. Type in the desired search string (e.g., “File Fetcher”).

8. Click the Search button. When the search is complete, the search results are displayed in the Components and Data Access area. The search results replace the default list of components. You may notice multiple instances of the same component; this is because the same component may appear in multiple categories in the search results.
9. To use one or more components in a workflow, simply drag the desired components to the Workflow canvas.
10. To clear the search results and re-display the list of default components, click the Cancel button.

NOTE: If you know which component you want to use and its location in the Component library, you can navigate to it directly, and then drag it to the Workflow canvas.

4.5.3 Searching for Components in the Kepler Repository

The Kepler Repository allows users to upload and download workflow components to and from a centralized server. Users can search for available components via the Kepler interface. To search for components that are stored remotely in the Kepler repository in addition to the components contained in the local library:

1. Select the Components tab.
2. Click the Sources button
3. Check the Search checkbox on any remote repositories you wish to search and click Ok
4. Type in the desired search string (e.g., “ActorDesignedForWorkflow”).

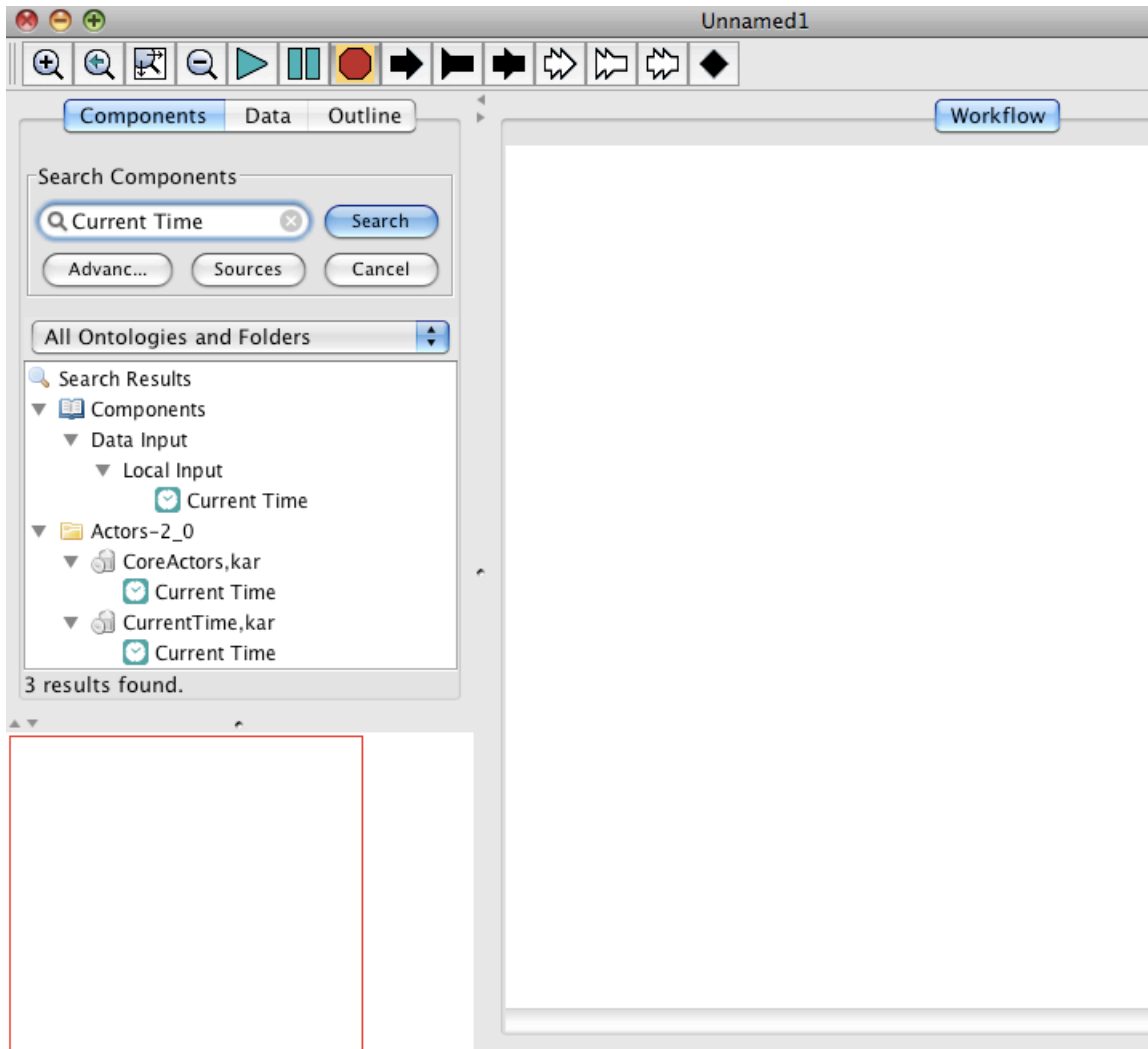

Figure 4.26: Searching the Kepler repository for components.

5. Click the Search button. When the search is complete, the search results replace the default list of components. You may notice multiple instances of the same component; this is because the same component may appear in multiple categories in the search results.
6. To use one or more components in a workflow, simply drag the desired components to the Workflow canvas, or right-click on a KAR result and select Download. The downloaded KAR will be placed into your local repository (by default, KeplerData/workflows/MyWorkflows/). If the component requires modules you do not have installed, Kepler will offer to download those modules. If this is required, you will probably have to restart Kepler afterwards to restore full functionality.
7. To clear the search results and re-display the list of default components, click the Cancel button.

NOTE: You can also search the Kepler Repository directly by going to <http://library.kepler-project.org/kepler/>. Actors and Workflows can be downloaded from this website and manually imported into Kepler.

5. Building Workflows with Existing Actors

Building workflows with existing actors is a relatively simple process that can be accomplished entirely on the Workflow canvas. Components need only be dragged and dropped onto the canvas, customized, connected, and run!

For example, the “Hello World” workflow is a very simple workflow that outputs the famous line “Hello World” until the workflow is paused or stopped (*Figure 5.1*). The workflow requires a *Constant* actor, a *Display* actor, and an SDF Director.

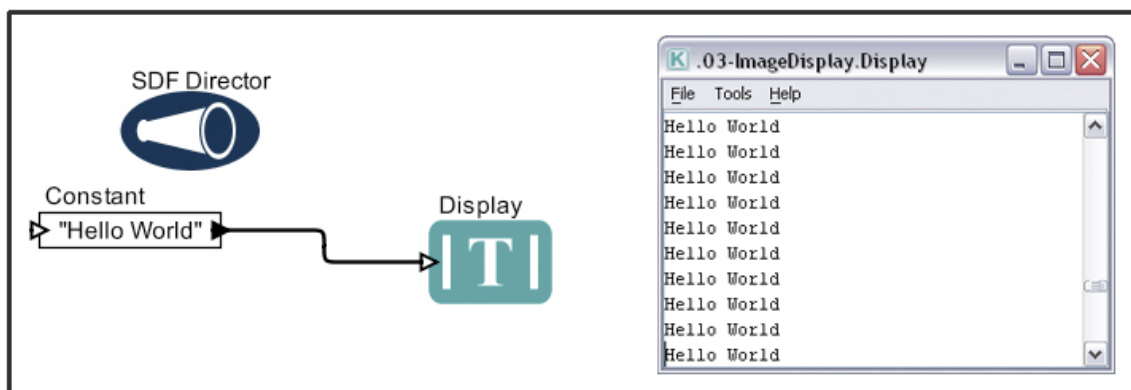

Figure 5.1: “Hello World” workflow and output.

To create the Hello World workflow:

1. Open Kepler. A blank Workflow canvas will open.
2. In the Components and Data Access area, select the Components tab, then navigate to the “/Components/Director/” directory.
3. Drag the *SDF Director* to the top of the Workflow canvas.
4. In the Components tab, search for “Constant” and select the *Constant* actor.
5. Drag the *Constant* actor onto the Workflow canvas and place it a little below the *SDF Director*.
6. Configure the *Constant* actor by right-clicking the actor and selecting Configure Actor from the menu. (*Figure 5.2*)

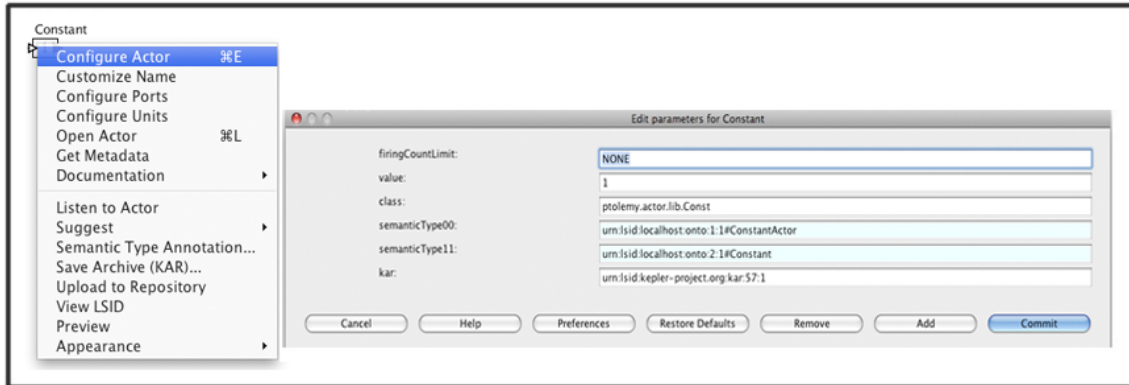

Figure 5.2: Configuring the *Constant* actor.

7. Type “Hello World” (including the quotes) in the `value` field of the “Edit parameters for Constant” dialog window and click Commit to save your changes. “Hello World” is a string value. In Kepler, all string values must be surrounded by quotes.
8. In the Components and Data Access area, search for “Display” and select the *Display* actor found under “Textual Output.”
9. Drag the *Display* actor to the Workflow canvas.
10. Connect the output port of the *Constant* actor to the input port of the *Display* actor.

You are now ready to run the workflow.

NOTE: By default, the *SDF Director* will continuously run a workflow, creating a loop. To run “Hello World” a limited number of times, right-click the *SDF Director* and select “Configure Director” from the menu. Type the desired number of iterations into the `iterations` field of the “Edit parameters for SDF Director” dialog window and click the Commit button to save your changes. For more information about SDF, see Section 5.2.1.

5.1 Prototyping Workflows

Before building a workflow in Kepler, the workflow must be prototyped. Much like a vacation plan—which might involve booking a flight and hotel room, checking the weather forecast, packing a suitcase, and catching a cab to the airport—scientific workflows also break down into a series of steps that often depend on the outcome of previous steps. Identifying the steps of your workflow, from reading data, to transforming and processing it, to outputting results in a desired format, is the bulk of the prototyping work. Once the functions of the workflow have been defined, you can focus on selecting the appropriate components from the Kepler library (and/or designing new components as necessary).

Kepler allows users to quickly prototype workflows. Scientists don't have to write an application, they just have to "draw" it, deciding what steps must be performed, what type of data the workflow will process, and what the output will be. Each step is ultimately represented by an actor, which uses ports to pass the required data. Figure 5.3 and Figure 5.4 display examples of conceptual workflows used to create Kepler workflows.

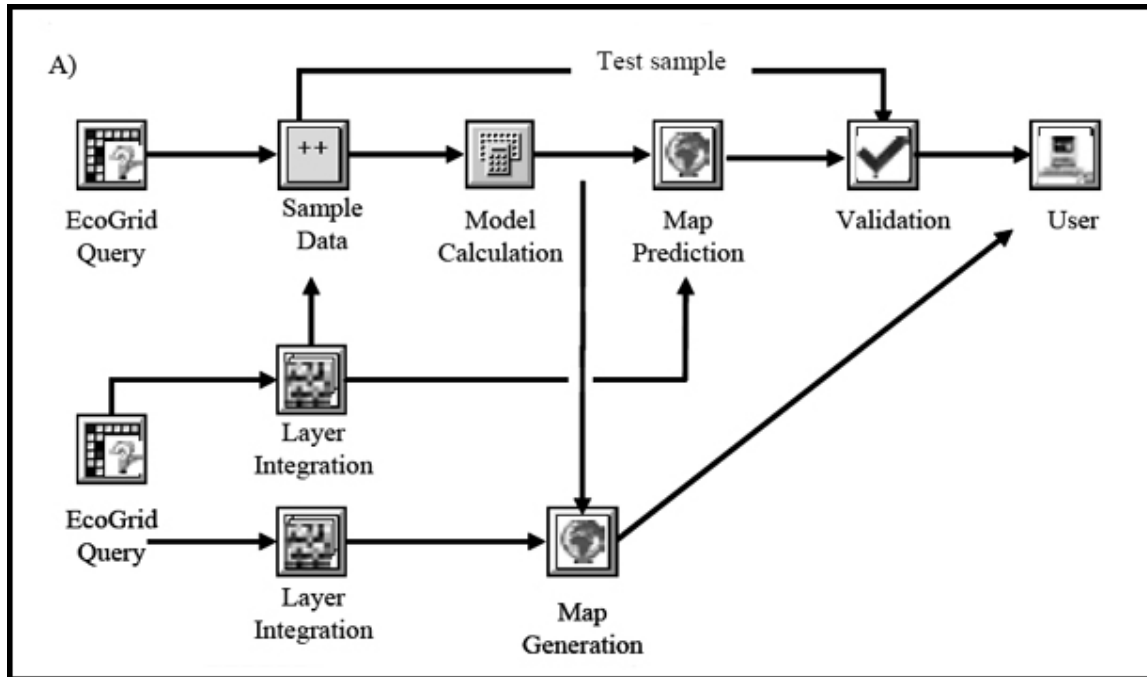

Figure 5.3: A conceptual prototype for a Kepler ecological niche modeling workflow¹³

¹³ See Pennington, Deana. July, 2005. The EcoGrid and the Kepler Workflow System: a New Platform for Conducting Ecological Analyses, *Bulletin of the Ecological Society of America*.

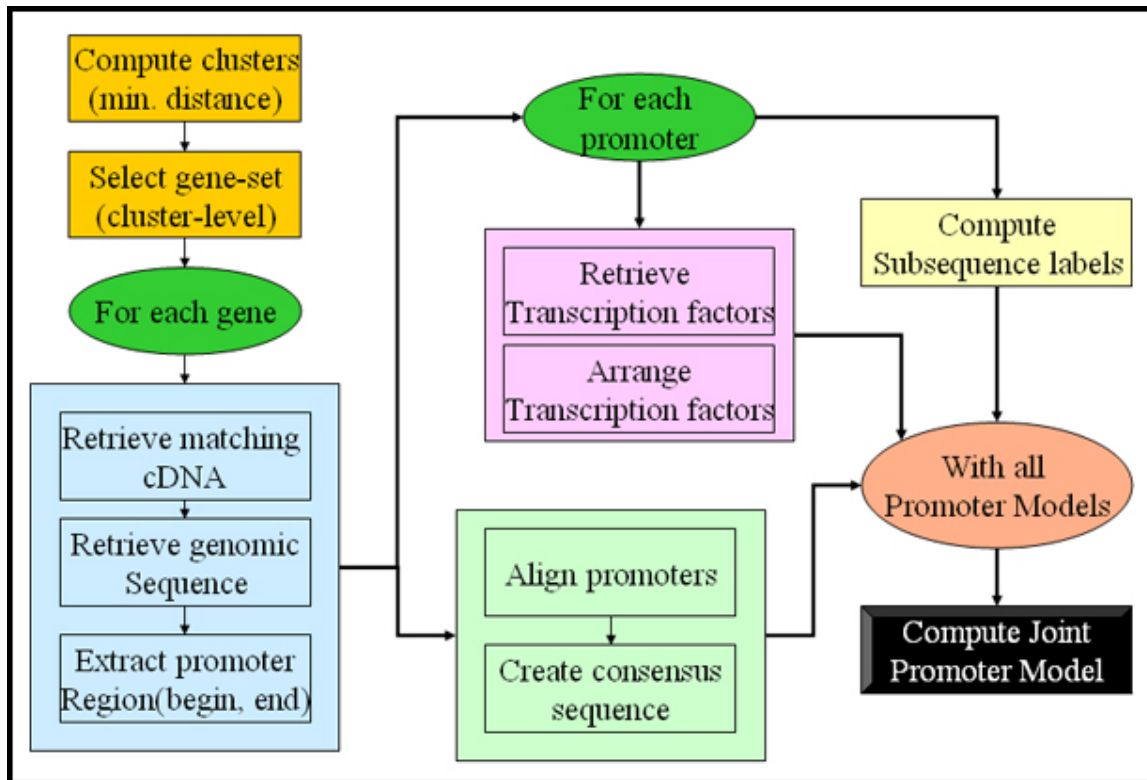

Figure 5.4: A conceptual prototype of the Promoter Identification workflow.¹⁴

Complex workflows can easily be prototyped in Kepler using the *CompositeActor* actor. Simply drag as many *CompositeActors* as needed to the Workflow canvas, add the number of input/output ports determined necessary, connect the components, and change the *CompositeActor* names to appropriately identify the function of the actor (Figure 5.5).

¹⁴ See Altintas, Iklay, Coleman, Matthew, Critchlow, Terence, Gupta, Amarnath, Ludaescher, Bertram, Peterson, Leif. Promoter Identification Workflow Specification. <http://kbi.sdsc.edu/SciDAC-SDM/piw-specification.ppt#256,1>, Promoter Identification Workflow Specification.

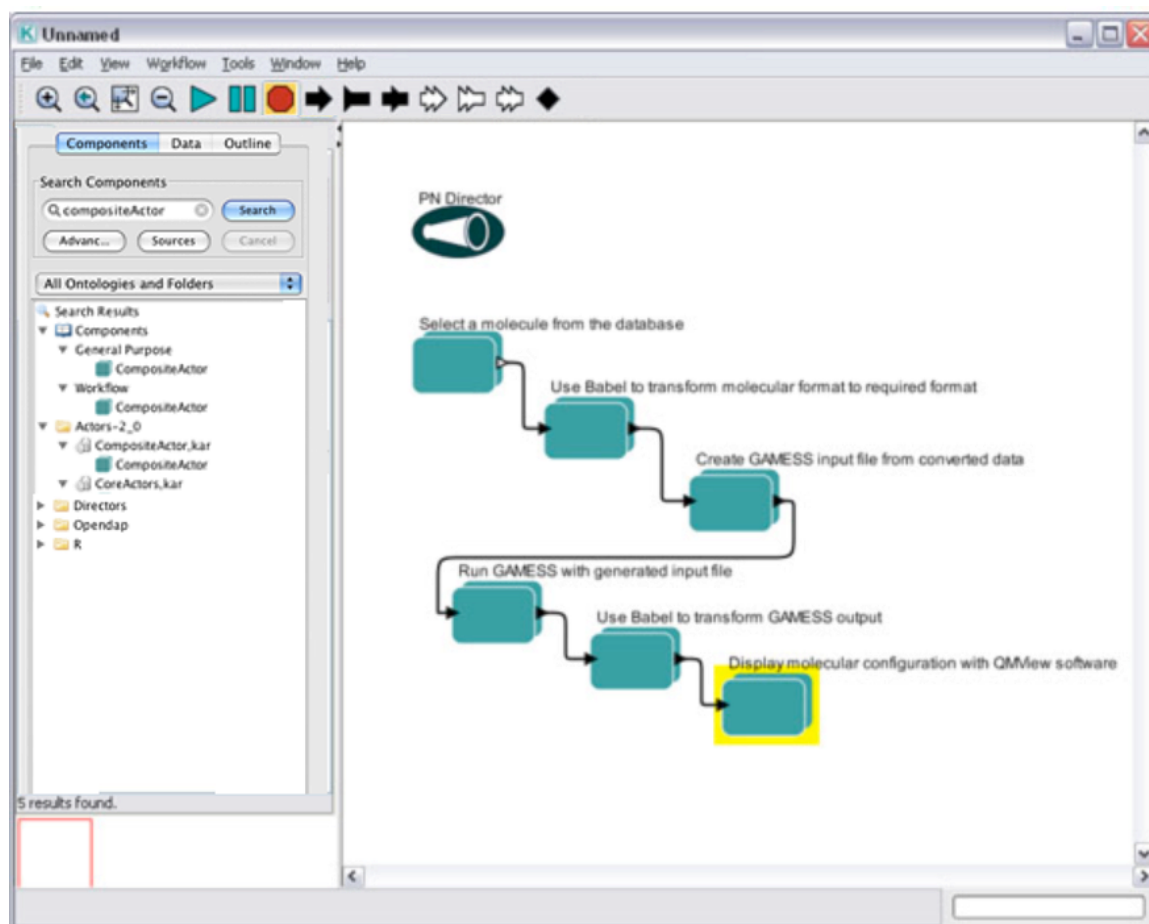

Figure 5.5: Using composite actors to prototype a workflow in Kepler.

In *Figure 5.5*, each *CompositeActor* represents a high level logical function in a workflow designed to prepare and run a GAMESS (General Atomic and Molecular Electronic Structure System) experiment and display the results. In the prototype stage, the actors don't need to do anything; later, as the workflow is developed, each of the composite actors can be opened, and detailed sub-workflows can be constructed inside (either with existing actors or new ones) to perform its task. For more information about composite actors, see Section 5.4.

5.2. Choosing a Director

Every workflow requires a director, but which one? Each of the directors packaged with Kepler—Synchronous Dataflow (SDF), Process Networks (PN), Dynamic Dataflow (DDF), Continuous (ContinuousDirector), Continuous Time (CT) and Discrete Events (DE)—has a unique way of instructing the actors in a workflow. Just as one would not hire David Lynch to direct a romantic comedy, or Steven Spielberg for a high school reunion flick, one would not, in general, use the SDF director for a workflow that

involves integrals, or the CT director for simple data transformation. But why? And how does one choose an appropriate director to use?

Which director to use under what circumstances is a question that should be answered during the initial stages of workflow design. As you sketch out the workflow steps and think about the types of processes the workflow will perform, keep the following questions in mind: Does the workflow depend on time? Does the workflow require multiple threads or distributed execution? Does it perform a simple data transformation with constant data production and consumption rates? Is the model described by differential equations? The answer to these questions will often indicate the best director to use.

In the next section, we will take a closer look at the above questions and how each can help in the director selection process.

Question 1: Does the workflow explicitly depend on time?

Though every task we perform—from balancing a checkbook to integrating polynomials and trigonometric functions by hand—requires time, not every Kepler workflow needs to understand that time passes. A workflow that reformats one type of static data file into another type needs to be able to read the input format and know how to translate it, but does not need to know that three seconds has passed between the time the workflow began and the time it finished. A workflow that examines a series of molecules and compares (or models or displays, etc) their structures is another example of a workflow that has no need for a concept of time. The director of these workflows must know how to order the events—at what point in the workflow each actor must perform—but it does not need to schedule the actors' actions at specific times.

Some workflows require a notion of time. A workflow that describes resource-limited population growth—where population is a function of time and the rate of population change (i.e., a simple linear extrapolation)—must incorporate time in order to calculate predicted growth. A workflow that models events that occur at discrete times—the times at which lightning strikes a particular point and the best way to minimize one's chance of being struck, for example—also requires a notion of time. Note that "model" time and "real" time can differ. For example, an analysis may take only seconds of "real" time to perform, but the "model" time may have advanced by several hours or more.

Some Kepler directors are best suited for time-dependent workflows and others for time-independent workflows. In general, if a workflow requires a notion of time, you should use a Continuous, CT or DE director. If a workflow does *not* require a notion of time, use an SDF, PN or DDF director. We'll talk more about each of these directors and how they work later in this chapter.

Question 2: Does the workflow require independent threads and/or distributed execution?

If the answer to Question 1 is no, skip to Question 4. If you determine that a workflow does *not* require a notion of time, the next question to ask is whether or not the workflow requires multiple threads (i.e., independent workflow processes that run in parallel) and/or distributed execution (i.e., remote data processing or access). If so, the workflow should most likely use a *PN Director*.

In a PN workflow, each actor has its own Java thread, permitting the workflow to perform multiple tasks simultaneously. A workflow can query a remote database, for example, and simultaneously process other calculations, even if the query results are delayed. The *PN Director* is also well suited for overseeing workflows that require complex logic.

In DDF and SDF workflows, actors are executed one at a time with a single thread of execution for the workflow.

Question 3: Does the model perform a simple data transformation with constant data production and consumption rates?

If you determine that a workflow does *not* require a notion of time *nor* multiple threads and/or distributed execution, the next question to ask is: Does the model perform a simple data transformation with constant data production and consumption rates?

A simple data transformation is one that does *not* involve deeply hierarchical or recursive structures. Examples of simple data transformations include converting one type of token to another (a series of items to an array, for example), translating one file format to another (an XML file to an HTML Web page, for example), calculating the average of a series of values, or reading a file and outputting a specific line or value.

A "constant data rate" means that all actors in the workflow consume and produce a consistent, pre-determined number of data tokens every time the workflow iterates. A token can be thought of as a container used to hold data of various types (strings, integers, objects, arrays, etc.). Note that even though an array may consist of multiple items, it is represented by a single token that is passed from the output port of one actor to the input port of another via channels.

In the simplest constant rate workflow, actors consume one data token on each input port and produce one token on each output port whenever the workflow executes ('fires'). An example is a workflow that simulates a coin toss by using the *Bernoulli* and *Display* actors to generate and display a series of random `true` and `false` values. This workflow has a constant data rate because each time it is run, the *Bernoulli* actor generates and outputs one token of data, and the *Display* actor receives and displays

exactly one token as well. Workflows may still have a constant data rate even if they contain actors that consume and/or produce more than one token each time they execute. For example, a workflow that uses the *TokenDuplicator* actor to receive a single token and output three duplicated tokens has a constant data rate (i.e., the actor consumes one token and produces three each time it executes) even though the number of tokens consumed and produced is not equivalent. However, actors that consume and produce a different number of tokens each time they execute (e.g., a *BooleanSwitch* actor that outputs a `true` value if the input value is `true`, and produces no output otherwise) do not have a constant data rate.

If you determine that your workflow performs a simple data transformation and has a constant data rate, you will most likely use an *SDF Director* to oversee the workflow. Because data rates are constant, the *SDF Director* can pre-calculate a workflow execution schedule, making the director very efficient. Under a *DDF Director*, data consumption and production rates do not have to be constant, allowing for more dynamic execution. *DDF Directors* are well suited for control structures (e.g., if/then/else) using *BooleanSwitch* and *DDFBooleanSelect* actors, which consume or produce tokens on different channels based on the token received from the control port.

Question 4: Is the model described by differential equations?

If you have determined that your workflow depends on time (i.e., the answer to Question 1 is "yes"), the next question you should ask is: Is the model described by differential equations?

Differential equations are most often used by workflows that describe dynamic systems (systems that depend upon a continuously varying time parameter, such as the population growth of a predator and/or its prey over time) or workflows that are used to perform numerical integration. These workflows should use a *Continuous* or *CT Director*, which are designed to work with ordinary differential equations.

Time-oriented workflows that do *not* involve differential equations will likely use a *DE Director* to execute events at specified times (e.g., to process information--sensor data, for example--that has a time stamp) or for scheduling simulations (a queuing system, for example).

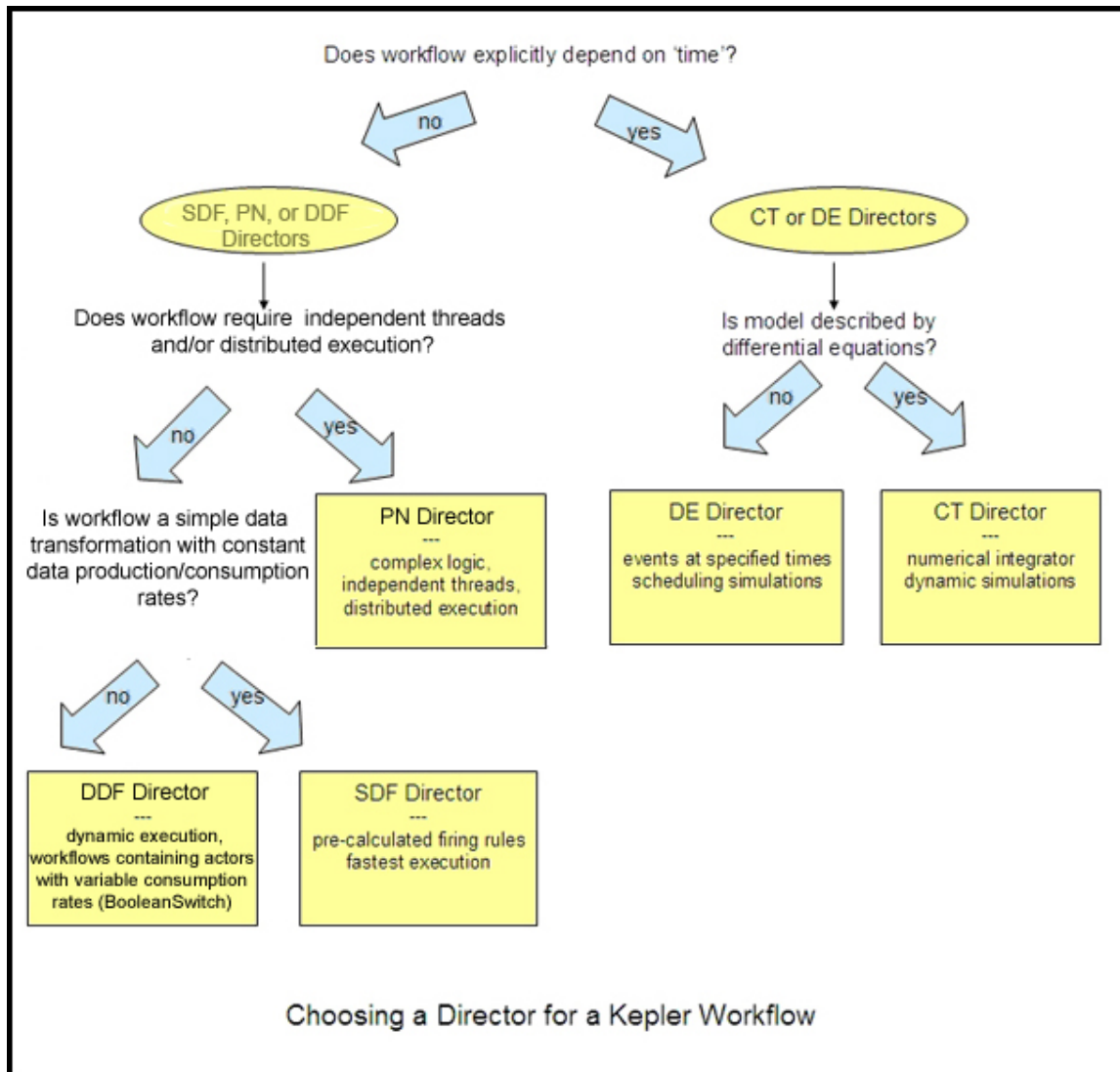

Figure 5.6: Choosing a director.

In most cases, you can determine the appropriate director to use for a workflow just by answering a handful of questions. *Figure 5.6* provides a useful quick-reference.

The six directors included in the default Kepler suite: SDF, PN, DDF, ContinuousDirector, CT, and DE, are the most commonly used directors, and each is described in the following sections. However, Kepler software supports the full range of directors used by Ptolemy. For more information about additional directors, please see the [Ptolemy documentation](#).

5.2.1 Synchronous Dataflow (SDF)

The *SDF Director* is very efficient and will not tax system resources with overhead. It achieves this efficiency by precalculating the schedule for actor execution. However, this

efficiency requires that certain conditions be met, namely that the data consumption and production rate of each actor in an SDF workflow be constant and declared. If an actor reads one piece of data and calculates and outputs a single result, it must always read and output a single token of data. This data rate cannot change during workflow execution and, in general, workflows that require dynamic scheduling and/or flow control cannot use this director. Additionally, the *SDF Director* has no understanding of passing time (at least by default), and actors that depend on a notion of time may not work as expected. For example, a *TimedPlotter* actor will plot all values at time zero when used in SDF.

The *SDF Director* is often used to oversee fairly simple, sequential workflows in which the director can determine the order of actor invocation from the workflow. Types of workflows that would run well under an *SDF Director* include processing and reformatting tabular data, converting one data type to another, and reading and plotting a series of data points. A workflow in which an image is read, processed (rotated, scaled, clipped, filtered, etc.), and then displayed, is also an example of a sequential workflow that requires a director simply to ensure that each actor fires in the proper order (i.e., that each actor executes only after it receives its required inputs). In *Figure 5.7*, the *SDF Director* ensures that the image is not displayed until it is processed, and that the image is not processed until it is read.

By default, the *SDF Director* requires that all actors in its workflow be connected. Otherwise, the director cannot account for concurrency between disconnected workflow parts. Usually, a *PN Director* should be used for workflows that contain disconnected actors; however, the *SDF Director's* `allowDisconnectedGraphs` parameter can be set to true. The *SDF Director* will then schedule each disconnected ‘island’ independently. The director cannot infer the sequential relationship between disconnected actors--nothing “forces” the director to finish executing all actors on one island before firing actors on another. However, the order of execution within each island should be correct. Usually, disconnected graphs in an SDF model indicate an error.

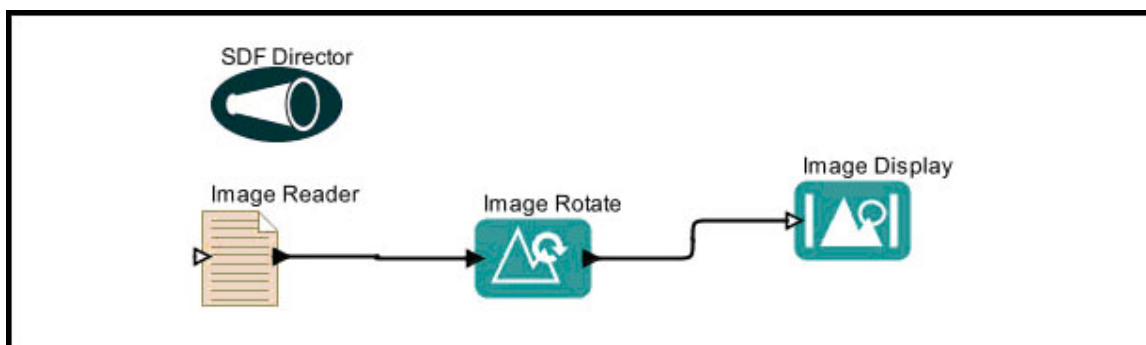

Figure 5.7: A simple SDF workflow used to read, process, and display an image. Note that all actors are connected and that the workflow does not depend on the passage of time.

Workflows that require loops (feeding an actor's output back into its input port for further processing) can cause "deadlock" errors under an *SDF Director* (or any director, for that matter). The deadlock errors occur because the actor depends on its own output value as

an initial input. To fix this problem, use a *SampleDelay* actor to generate and inject an initial input value into the workflow. The workflow in *Figure 5.8* uses a *SampleDelay* actor to set an initial population value (n) of 1 that is used when the workflow first iterates.

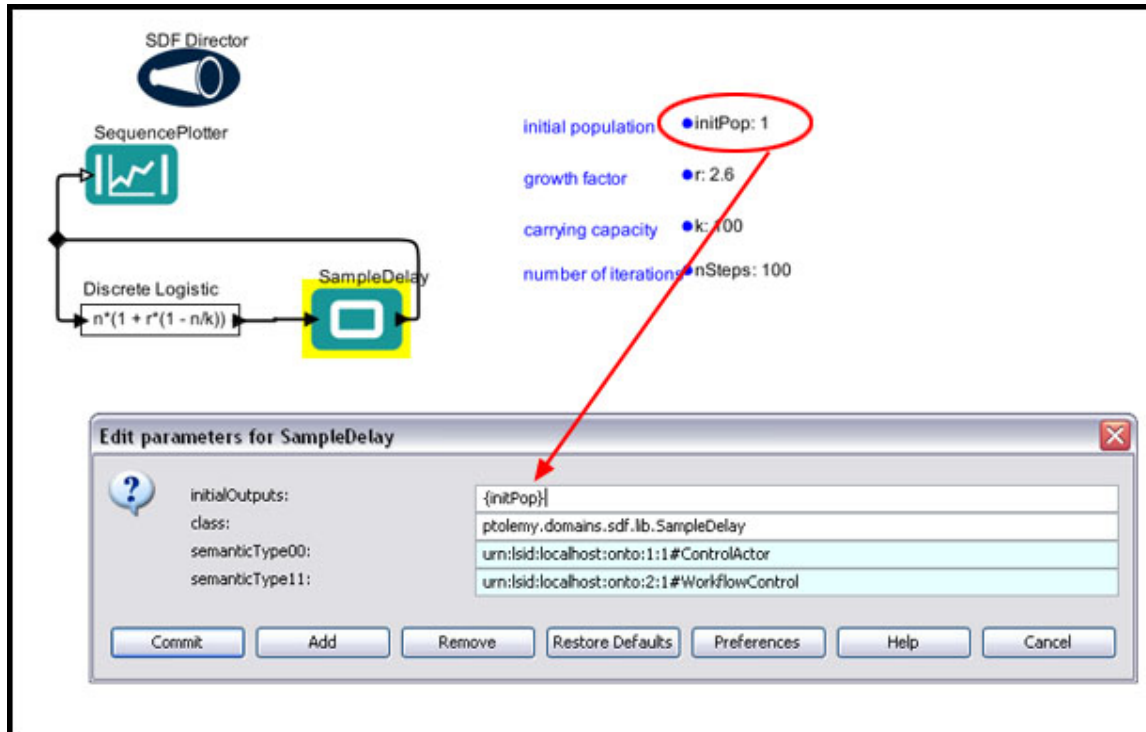

Figure 5.8: Using a *SampleDelay* actor to prevent deadlock errors. The above workflow can be found under `$kepler/demos/SEEK/DiscreteLogistic_SDF_Director.xml`.

SDF Directors control how many times a workflow is iterated. Most often, a workflow need be run only once, but there are instances in which a workflow should iterate more than once: if a workflow contains a loop that should be executed several times, for example, as in *Figure 5.8*.

In *Figure 5.8*, a workflow loop is used to feed the output of an *Expression* actor called *Discrete Logistic* back into its input (as well as into a *SequencePlotter*, which plots the data) so that a new result can be calculated using the previous result. The *SDF Director* specifies that the loop iterate 100 times before stopping. Note that a *SampleDelay* actor is used to generate an initial population value, which is used the first time the workflow runs.

The number of times a workflow is iterated is controlled by the director's `iterations` parameter. By default, this parameter is set to "0". Note that "0" does not mean "no iterations." Rather, "0" means that the workflow will iterate forever. Values greater than zero specify the actual number of times the director should execute the entire workflow. A value of 1, meaning that the director will run the workflow once, is often the best setting when building an SDF workflow.

The *SDF Director* also determines the order in which actors execute and how many times each actor needs to be fired to complete a single iteration of the workflow. This schedule is calculated BEFORE the director begins to iterate the workflow. Because the *SDF Director* calculates a schedule in advance, it is quite efficient. However, SDF workflows must be static. In other words, the same number of tokens must be consumed/produced at every iteration of the workflow. Workflows that require dynamic control structures, such as a *BooleanSwitch* actor that sends output on one of two ports depending on the value of a 'control', cannot be used with an *SDF Director* because the number of tokens on each output can change for each execution.

Unless otherwise specified, the *SDF Director* assumes that each actor consumes and produces exactly one token per channel on each firing. Actors that do not follow the one-token-per-channel firing convention (e.g., *Repeat* or *Ramp*) must declare the number of tokens they produce or consume via the appropriate parameters. In *Figure 5.9*, a *Ramp* actor is used to generate five tokens, which are passed to a *SequenceToArray* actor. The number of tokens the *Ramp* actor generates is specified with the actor's `firingCountLimit` parameter. The *SequenceToArray* actor must be told to expect five tokens, not one. The workflow uses a *Constant* actor that contains a variable called `FiringCountLimit` to tell the *SequenceToArray* actor to expect five tokens. The *SequenceToArray* actor reads the input tokens, generates a single array from them, and outputs a single token containing a five element array. Because the output of the *SequenceToArray* actor as well as the input of the *Display* actor conform to the one-token-per-channel firing convention, there is no need to specify a data consumption/production rate.

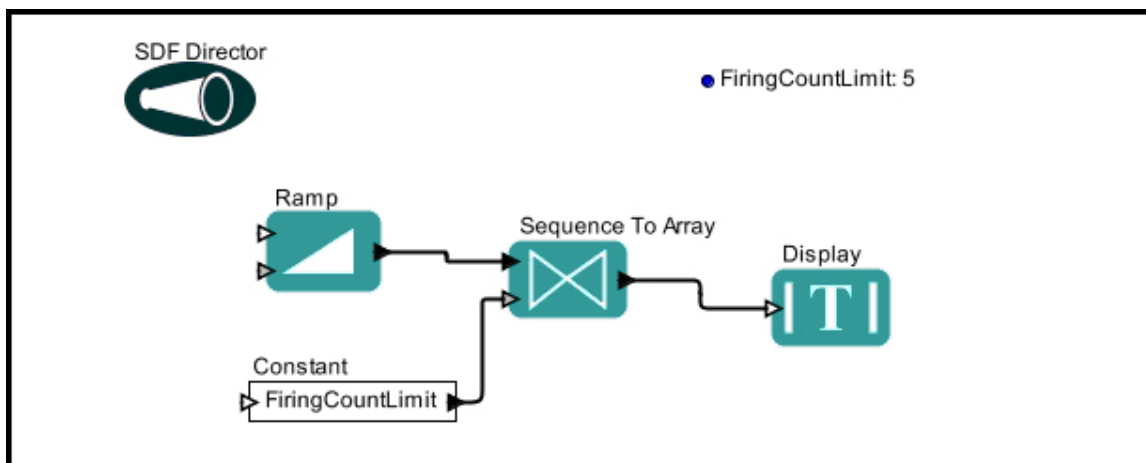

Figure 5.9: An example of an SDF workflow. Note that the data consumption rate for the *SequenceToArray* actor must be specified before the workflow is run.

The amount of data processed by an SDF workflow is a function of both the number of times the workflow iterates and the value of the director's `vectorizationFactor` parameter. The `vectorizationFactor` is used to increase the efficiency of a workflow by increasing the number of times actors fire each time the workflow iterates.

If the parameter is set to a positive integer (other than 1), the director will fire each actor the specified number of times more than normal. The default is 1, indicating that no vectorization should be performed. Customizing the `vectorizationFactor` parameter can be useful when modeling block data processing. For example, a signal processing system that filters blocks of 40 samples at a time using a finite-impulse response (FIR) filter can be built using a single sample filter, provided the `vectorizationFactor` parameter of the SDF Director is set to 40. Here, each firing of the SDF model corresponds to 40 firings of the single sample FIR filter.¹⁵ Keep in mind that changing the `vectorizationFactor` parameter changes the meaning of a nested SDF workflow and may cause deadlock in a workflow that uses it.

The *SDF Director* has several advanced parameters that are generally only relevant when an SDF workflow contains composite components. In most cases the `period`, `timeResolution`, `synchronizeToRealTime`, `allowRateChanges`, `timeResolution`, and `constrainBufferSizes` parameters can be left at their default values.

For more information about the *SDF Director*, see the [Ptolemy documentation](#). The Ptolemy site also has a number of useful [examples](#).

5.2.2 Process Networks (PN)

The Process Network (PN) Director, unlike the *SDF Director*, does not statically calculate firing schedules. Instead, in a PN workflow each actor has an independent Java thread and the workflow is driven by data availability: tokens are created on output ports whenever input tokens are available and output can be calculated. Output tokens are passed to connected actors, where they are held in a buffer until that next actor collects all required inputs and can fire. The *PN Director* finishes executing a workflow only when there are no new data token sources anywhere in the workflow.

Because PN workflows are very loosely coupled, they are natural candidates for managing workflows that require parallel processing on distributed computing systems. PN workflows are powerful because they have few restrictions. On the other hand, they can be very inefficient because the director must keep looking for actors that have sufficient data to fire. (Remember that for SDF, the execution schedule is determined once, before the workflow starts to execute.)

The same execution process that gives the *PN Director* its flexibility can also lead to some unexpected results: workflows may refuse to automatically terminate because tokens are always generated and available to downstream actors, for example. If one actor fires at a much higher rate than another, a downstream actor's memory buffer may overflow, causing workflow execution to fail.

¹⁵ Please see the [Ptolemy documentation](#) for more information

The workflow in *Figure 5.10* appears to generate a constant and display it. However, this workflow may *not* work correctly due to the interaction between the *Constant* actor, which, by default, always produces an output when "asked" by the director, and the *PN Director*, which always asks for an actor's output unless the actor indicates that it is finished. Because the *Constant* actor is never "finished", the *PN Director* will continue to ask for output, and the workflow will iterate forever--or at least until the input buffer of the *Display* actor overflows. One can correct the problem by changing the `firingCountLimit` parameter of the *Constant* actor to some finite value (*Figure 5.11*).

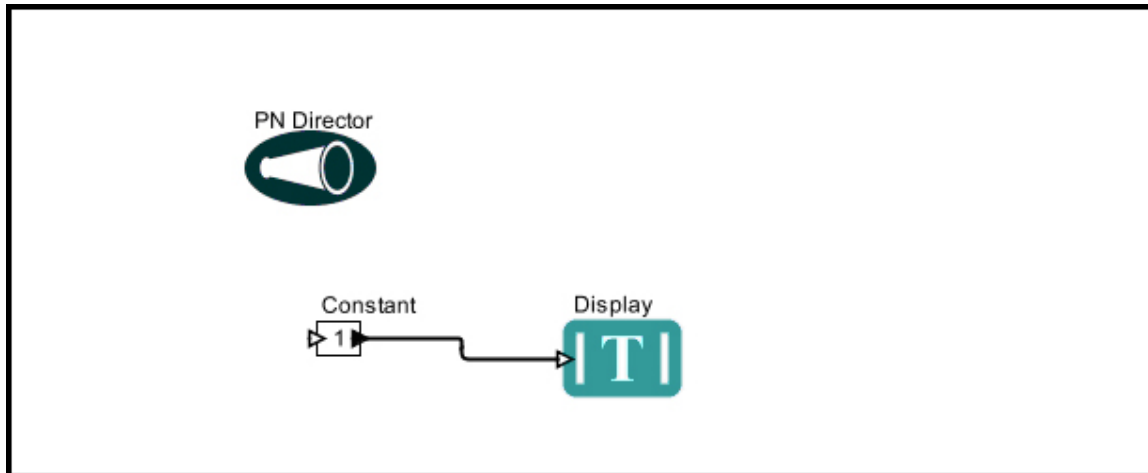

Figure 5.10: This workflow will not work under the *PN Director* unless the *Constant* actor's `firingCountLimit` parameter is set to a finite value.

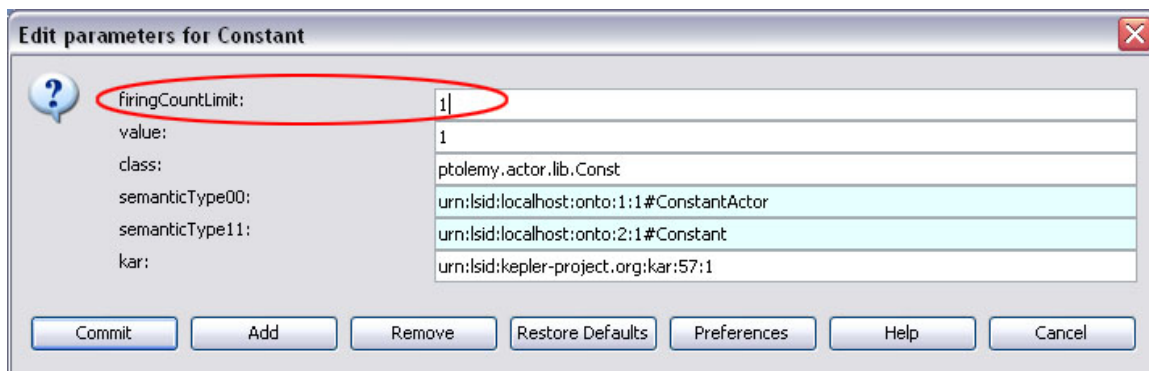

Figure 5.11: Set the `firingCountLimit` parameter to an integer to use the *Constant* actor under a PN director.

The *PN Director* has several advanced parameters (`initialQueueCapacity` and `maximumQueueCapacity`) that are only relevant for performance tuning in special cases. For most workflows, leave these parameters at their default values.

For more information about the *PN Director*, see the [Ptolemy documentation](#). The Ptolemy site also has a number of useful [examples](#).

5.2.3 Discrete Events (DE)

The Discrete Event (DE) Director, which oversees workflows where events occur at discrete times along a time line, is well suited for modeling time-oriented systems, such as queuing systems, communication networks, and occurrence rates or wait times. One classic problem that a DE Director can manage well is the bus station/bus rider problem, where buses and riders arrive at a bus station at random or fixed rates and the public transit director wishes to calculate (or minimize) the amount of time that riders must wait.

In DE workflows, actors send "event tokens," which consist of a data token and a time stamp. The director reads these tokens, and places each on a global, workflow timeline. Large event queues or queues that change often are "expensive" in terms of system resources and may have performance issues.

All actors in a DE workflow must receive input tokens, even if the tokens are solely used as triggers. Once active, an actor will fire until it has no more tokens in its input ports, or until it returns false.

Because *DE* actors only fire only after they receive their inputs, workflows that require loops (feeding an actor's output back into its input port for further processing) can cause "deadlock" errors. The deadlock errors occur because the actor depends on its own output value as an initial input. To fix this problem, use a *TimedDelay* actor to generate and inject an initial input token.

The *DE Director* and each event in its workflow contain a tag that consists of a timestamp and additional information that helps the director determine when to process each event. On each iteration, the director will process all events with tags that are equal to its tag (the "model tag"), and then advance its model tag and perform a new set of matching events. Note that "model time" is not "real time." Model time starts from the time specified by `startTime` parameter, which has a default value of 0.0. The stop time is specified by the `stopTime` parameter, which has a default value of `Infinity`, meaning that the execution will run forever.

Execution of a DE model ends when the timestamp of the earliest event exceeds the stop time. By default, execution also ends when the global event queue becomes empty. To prevent ending the execution when there are no more events (if your workflow relies on user interaction, for example), set the `stopWhenQueueIsEmpty` parameter to `false`.

If the parameter `synchronizeToRealTime` is set to `true`, then the director will not process events until the real time elapsed since the model started matches the timestamp of the event. Synchronizing ensures that the director does not get ahead of real time; however, synchronizing does not ensure that the director keeps up with real time.

The *DE Director's* `timeResolution` parameter is an advanced parameter that is only useful when the DE workflow contains composite components. In general, leave the parameter set to its default value ("1E-10")

For more information about the *DE Director*, see the [Ptolemy Documentation](#). The Ptolemy site also has a number of useful [examples](#).

5.2.4 Continuous Time (CT)

The Continuous Time (CT) Director is designed to oversee workflows that predict how systems evolve as a function of time (i.e., "dynamic systems"). In CT workflows, the rates of change of parameters are related to the current value or rates of change of other parameters, often in complex and coupled ways that are described by differential equations. For example, the change in the population of a predator and its prey over time (described by the Lotka-Volterra equations), can be calculated using a CT workflow (see *Section 4.2.3*). In general, CT workflows function much like STELLA, a common commercial software package that calculates dynamic (or continuous time) responses.

The *CT Director* keeps track of the "time" of each iteration as well as the time between each iteration (the "time step"). By insuring that the time step is small enough, the director can use simple extrapolations to estimate new values. The *CT Director* then iterates the workflow enough times to reach the desired stop time. The entire process is thus just numerical integration.

Figure 5.12 shows a simple workflow that uses the *CT Director* to calculate resource-limited population growth. The integrand of the logistic equation that is commonly used to describe resource-constrained population growth is entered into an *Expression* actor. The output of the *Expression* actor (labeled *Logistic Model*) is connected to the input of an *Integrator* actor, which calculates the population growth rate at a future time (derived from the current time plus the time step specified by the director) given the current rate of growth (output by the *Expression* actor). The output of the *Integrator* is then connected back to the input of the *Expression* actor. This loop is then iterated a number of times by the *CT Director*, numerically integrating the differential equation.

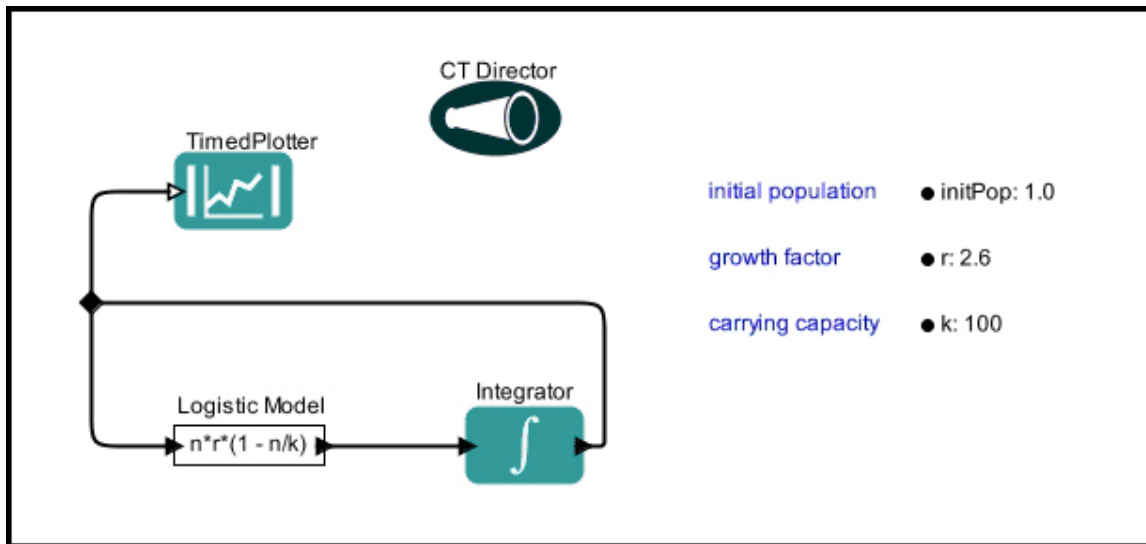

Figure 5.12: A workflow using a CT Director.

The *CT Director* in the above example is set to integrate for 100 seconds. Using the initial values for growth (r) and carrying capacity (k), the workflow calculates the growth rate at later times and outputs a graph representing the results. The curve rises at a rate determined by the growth rate, and then levels off at the carrying capacity (Figure 5.13).

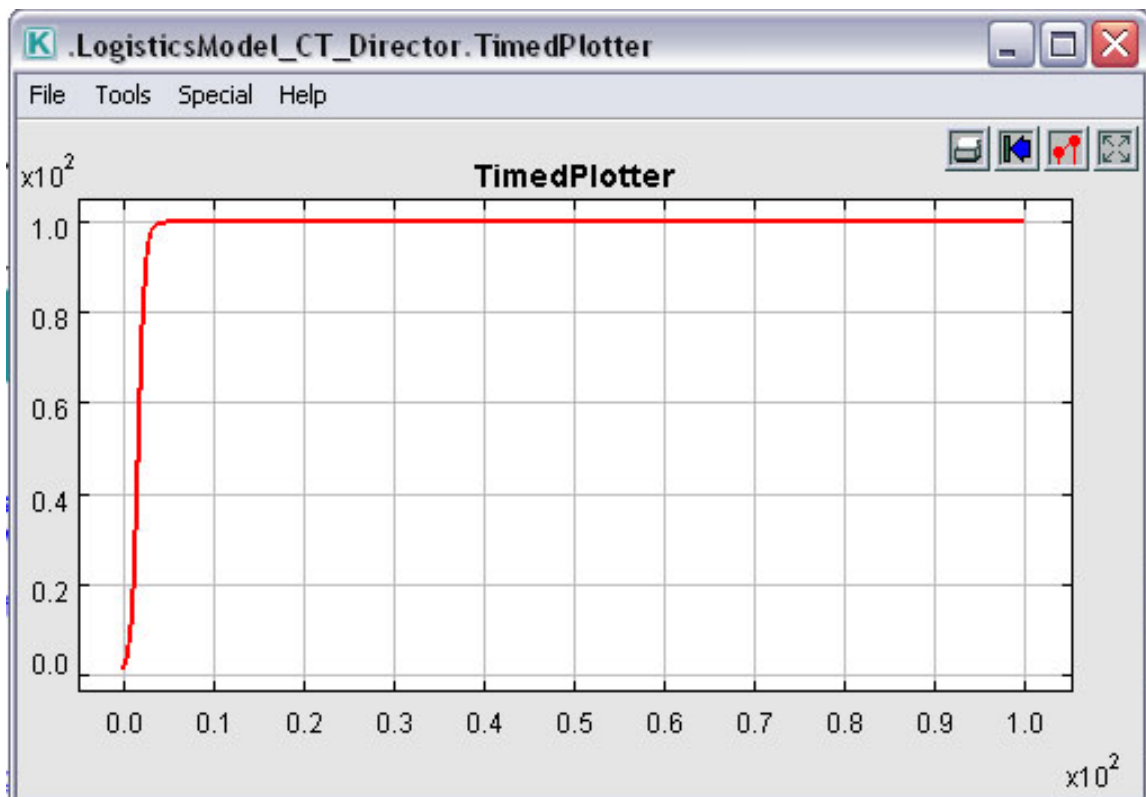

Figure 5.13: Output of the resource-limited population growth workflow

The *CT Director* calculates the size of integration steps in the numerical integration and can be configured to use different extrapolation algorithms. How the director performs the integration depends on the ordinary differential equation (ODE) solver algorithm selected with the `ODESolver` parameter. By default, the *CT Director* uses the `ExplicitRK23Solver` algorithm. Each of the four available ODE solver algorithms: `ExplicitRK23Solver`, `ExplicitRK45Solver`, `BackwardEulerSolver`, and `ForwardEulerSolver` have different performance and accuracy characteristics depending on the function being integrated. Some of the algorithms (`ForwardEulerSolver` and `BackwardEulerSolver`) are "fixed step" algorithms, meaning that users specify a constant integration step size to be used throughout the integration. Others are "variable-step-size" algorithms (`ExplicitRK23Solver` and `ExplicitRK45Solver`), meaning that the director will change step sizes according to error estimation. For a detailed discussion of these algorithms, see the Ptolemy documentation (Volume 3, Chapter 2).

In general, the relevance of the director's parameters varies depending on the type of ODE solver algorithm selected. If the algorithm is fixed-step (`ForwardEulerSolver` and `BackwardEulerSolver`), the director will use the value specified by the `initStepSize` as the step size. The specified value is a 'guess' at an initial integration step size. If the integral does not look right, changing the `initStepSize` might provide a better result. For variable-step-size algorithms (`ExplicitRK23Solver` and `ExplicitRK45Solver`), step-size will change based on the rate of change of the original function's values (i.e., derivative values). In other words, time-steps within an integration will change throughout the calculation, and the `initStepSize` is used only as an initial suggestion.

Directors with variable-step-size algorithms use the `maxStepSize` and `minStepSize` parameters to set upper and lower bounds for estimated step sizes. These parameters are used for adjusting tradeoffs between accuracy and performance. For simple dynamic systems, setting an upper bound with the `maxStepSize` parameter helps ensure that the algorithm will use an adequate number of time points. For more complex systems, the `minStepSize` ensures that the algorithm will not gobble too many system resources by using increasingly minute step sizes. The `minStepSize` is also used for the first step after breakpoints.

The `timeResolution` parameter is also used to adjust the tradeoff between accuracy and speed. In general, one would not change this parameter unless a function is known to change substantially in times of less than the parameter's default value, 1E-10 sec. The parameter helps ensure that variable-step-size algorithms do not use unnecessarily small time steps that would result in long execution times. Reducing the parameter's value might produce more accurate results, but at a performance cost.

The `errorTolerance` parameter is only relevant to directors that use variable-step-size algorithms. Workflow actors that perform integration error control (e.g., the *Integrator* actor) will compare their estimated error to the value specified by the `errorTolerance` parameter. If the estimated error is greater than the `errorTolerance`, the director will decide that the step size is inaccurate and will

decrease it. In most cases, the default value of the `errorTolerance` parameter ($1e-4$) does not require change

The `startTime` and `stopTime` parameters specify the initial and final time for the integration. By default, the time starts at 0 and runs to infinity. Note: the `startTime` and `stopTime` parameters are only applicable when the *CT Director* is at the top level. If a CT workflow is contained in another workflow, the *CT Director* will use the time of its executive director.

The `maxIterations` parameter specifies the number of times the director will iterate to determine a "fixed point." A fixed point is reached if two successive iteration steps produce the "same" result. How close values must be to be considered fixed is specified with the `valueResolution` parameter, which defaults to $1e-6$.

The `synchronizeToRealTime` and `runAheadLength` parameters are advanced parameters that are generally only used when a CT workflow is nested in another workflow. For example, if the *CT Director* is embedded in an event-based workflow (e.g., a workflow that uses a *DE Director*), the *CT Director* will "run ahead" of the global time by the amount specified by the `runAheadLength` parameter, and prepare to roll back if necessary. The local current time in the sub-workflow is compared with the current time of the executive director. If the local time is later than the global time, then the directed system will rollback to a "known good" state. The "known good" state is the state of the system at the time when local time is equal to the current time of the executive director. In general, the `synchronizeToRealTime` and `runAheadLength` parameters should be left at their default values (*Figure 5.14*).

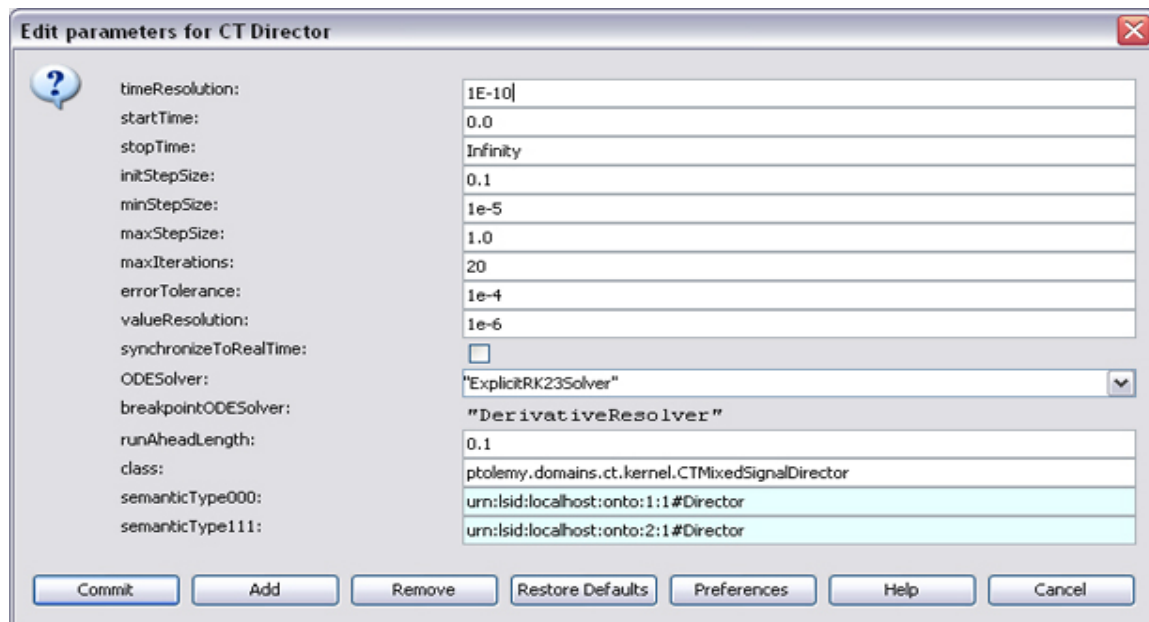

Figure 5.14: The *CT Director* parameters.

For more information about the *CT Director*, see the [Ptolemy documentation](#). The Ptolemy site also has a number of useful [examples](#).

5.2.5 Dynamic Dataflow (DDF)

A *DDF Director*, like the *SDF Director*, executes a workflow in a single execution thread, meaning that tasks cannot be performed in parallel as they can be under a *PN Director*. Unlike the *SDF Director*, however, the *DDF Director* makes no attempt to pre-schedule workflow execution, and data production and consumption rates can change as a workflow executes. This flexibility permits very dynamic workflow execution, and you will likely use this director for workflows that use *BooleanSwitch* and *DDFBooleanSelect* actors to create control structures, but that do not require parallel processing (in which case a *PN Director* should be used). In general, the *DDF Director* is a good choice to use for managing workflows that use Boolean switches for an if-then-else type constructs (*Figure 5.15*) and branching, or that require data-dependent iteration (e.g., multiplying an input integer until the product is greater than a set threshold—i.e., a "do while" loop).

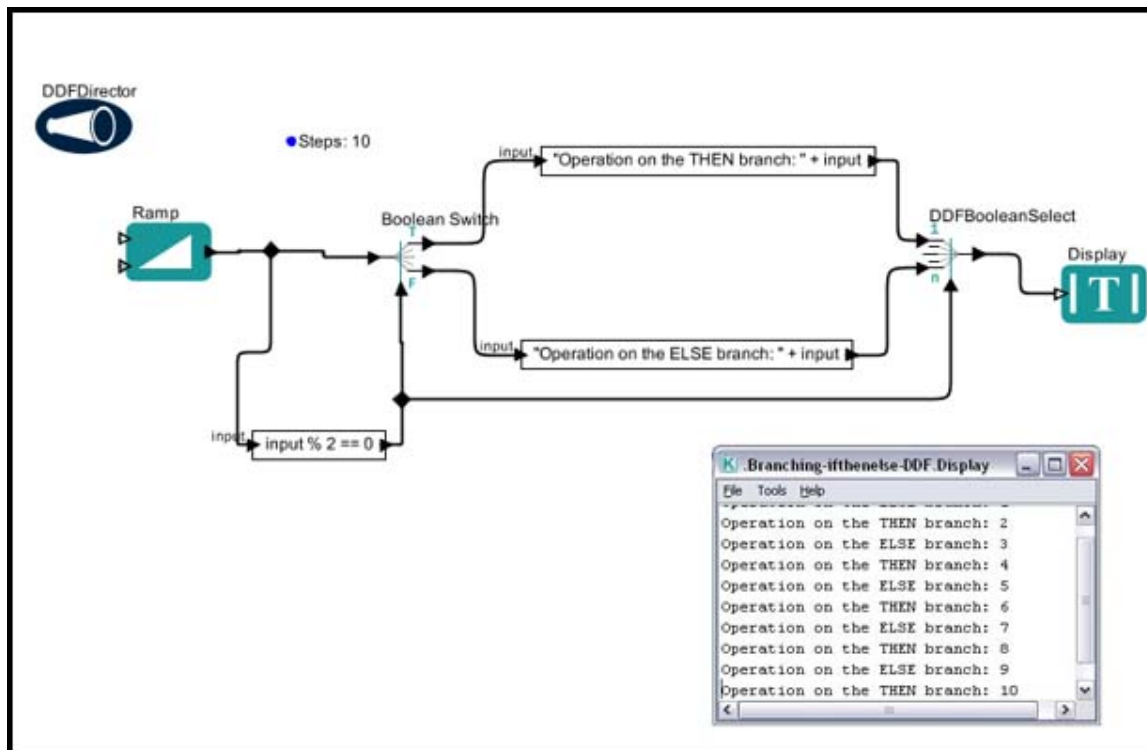

Figure 5.15: Using the *DDF Director* with a workflow that uses if-then-else type structure.

The workflow in *Figure 5.15* uses a *BooleanSwitch* actor to direct its input to either an "If" or an "Else" output, depending on the value of a token passed to the actor's control port. Because the output of the *BooleanSwitch* ports is not constant (sometimes the port will have output, sometimes not) the workflow cannot be run under an *SDF Director*, which requires constant data rates. Either a DDF or PN Director can

handle variable data rates, and because the workflow does not require parallel processing, the *DDF Director* is the better choice for this workflow.

Note that the workflow uses a *DDFBooleanSelect* actor specifically designed for DDF workflows. This actor should be used under *DDF Directors* instead of the *BooleanSelect* actor. Additional actors designed to work under DDF Directors, such as *DDFSelect* and *DDFOrderedMerge*, can be instantiated using the Tools > Instantiate Component menu option.

In *Figure 5.15*, the director's parameters are left at their default settings (*Figure 5.16*)

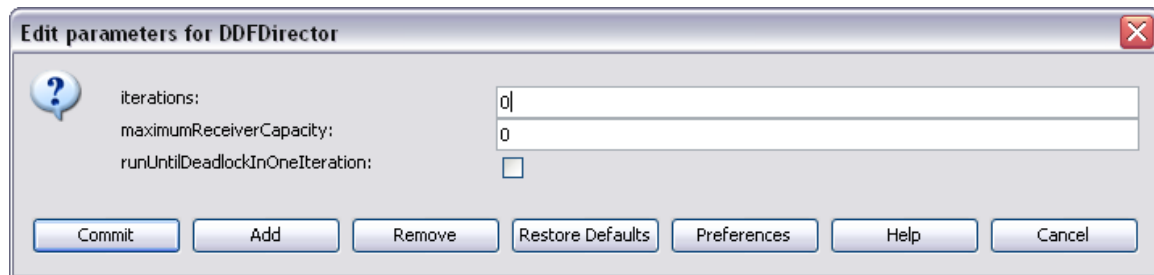

Figure 5.16: The default parameters of the *DDF Director*.

The iterations parameter is used to specify the number of times the workflow is iterated. By default, this parameter is set to "0". Note that "0" does not mean "no iterations." Rather, "0" means that the workflow will iterate forever. Values greater than zero specify the actual number of times the director should execute the entire workflow.

By default, the value of the `maximumReceiverCapacity` parameter is 0, which means that the queue in each receiver is unbounded. To specify bounded queues, set this parameter to a positive integer. The *DDF Director's* third parameter, `runUntilDeadlockInOneIteration`, can only be selected if the *DDF Director* is running a sub-workflow (i.e., you cannot turn this parameter on if the DDF director is the workflow's top-level director). In general, when using DDF in composite actors, it is useful to select this parameter to ensure that the subworkflow sends out one token each iteration. When `runUntilDeadlockInOneIteration` is selected, the director will repeat the basic iteration until deadlock is reached. Deadlock occurs when no active actors are able to fire because their firing rules are not satisfied.

By default, the *DDF Director* uses a set of firing rules that determine how to execute actors in a "basic iteration." Unlike the *SDF Director*, which calculates the order in which actors execute and how many times each actor needs to be fired BEFORE the director begins to iterate the workflow, the *DDF Director* determines how to fire actors at runtime, and the number of tokens produced and output by each actor can vary in each basic iteration. Users can ensure that a specified number of tokens are consumed or produced by either (1) setting a parameter named `requiredFiringsPerIteration` in workflow actors so that they are fired the specified number of times in each iteration (e.g., a *Display* actor that should display one token in each workflow iteration, or an actor that must output a single token to a

containing workflow on each iteration) or (2) by selecting the director's `runUntilDeadlockInOneIteration` parameter, in which case, in each iteration, the director will repeat the basic iteration until deadlock is reached. Deadlock occurs when no active actors are able to fire because their firing rules are not satisfied.

A simple example of a DDF sub-workflow contained by a PN workflow can be used to illustrate the usefulness of user-defined `requiredFiringsPerIteration` parameters and the *DDF Director's* `runUntilDeadlockInOneIteration` parameter. In the example in *Figure 5.17*, a *Ramp* actor outputs the integers from 1 to 8 to a composite *DDFACTOR*. Opening the *DDFACTOR* reveals a simple DDF sub-workflow that uses a relation to branch the input to two *Expression* actors: one which simply passes the value `true` to a *BooleanSwitch*, the other which outputs a string such as "This is string no 1" or "This is string no 2", etc. The output of the *DDFACTOR* is then passed to a *Display* actor.

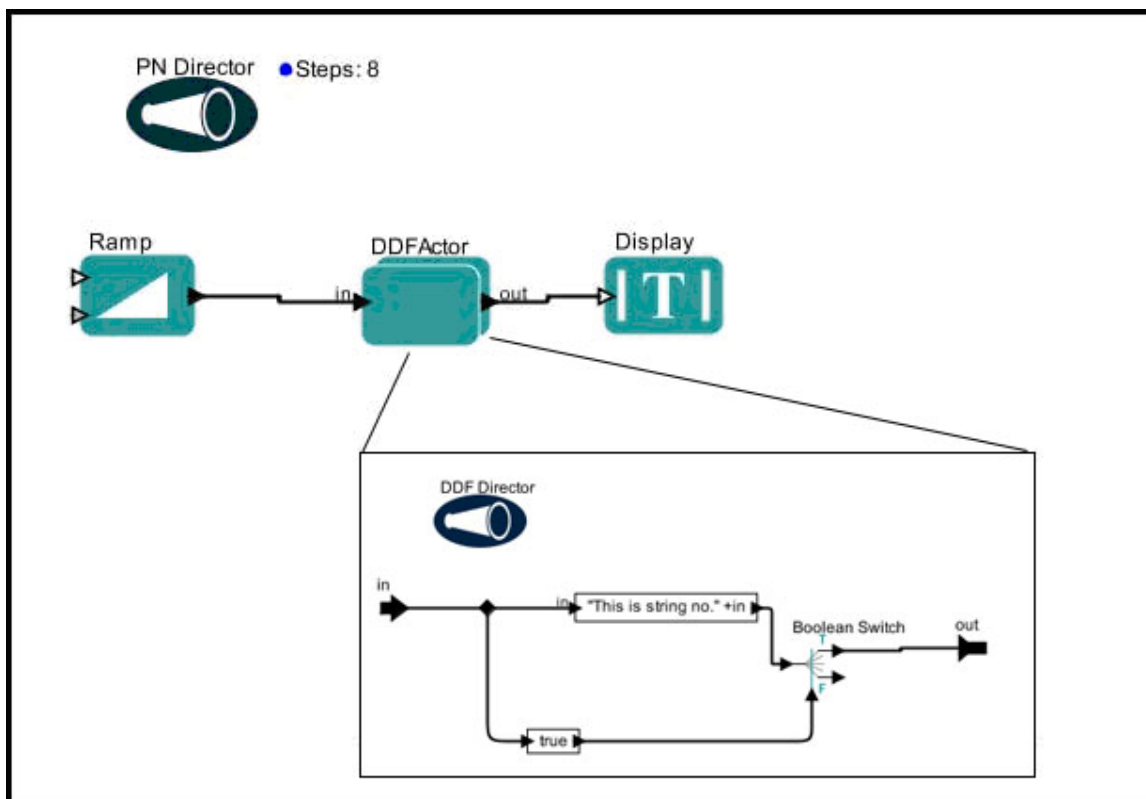

Figure 5.17: A DDF sub-workflow contained in a PN workflow.

The expected output of the workflow in *Figure 5.17* is a "list" of all eight strings generated by the *DDFACTOR* ("This is string 1", etc). However, when the workflow is run using the default actor and director settings, the following output is produced (*Figure 5.18*)



Figure 5.18: Output of the workflow displayed in *Figure 5.17* when all actor and director parameters use default settings

What happened to strings 5-8? The answer lies in how the *DDF Director* determines which actors to fire and when. In this case, the input comes from the containing workflow, and all eight values are passed to the sub-workflow correctly. Listening to the *DDF Director* during execution reveals that the expressions are fired in one iteration and that the last *Boolean Switch* is fired only in the next iteration (thus emitting a token every two iterations). In other words, one iteration is not a "full iteration" of the DDF subworkflow.

To ensure that the *BooleanSwitch* actor iterates and that the sub-workflow completes its task, one of the following techniques can be used:

- 1) Add a `requiredFiringsPerIteration` parameter to the *BooleanSwitch* actor specifying the number of tokens it must consume at each iteration. To add the new parameter, right-click the *BooleanSwitch* actor and select *Configure Actor*. Click the *Add* button and enter the name and value of the new parameter (*Figure 5.19*)

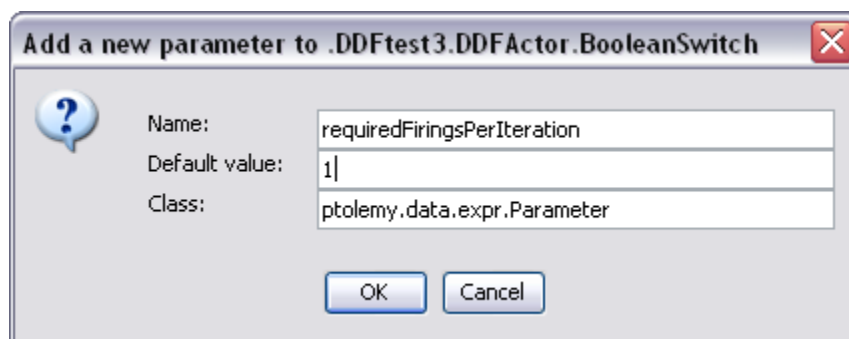

Figure 5.19: Adding the `requiredFiringsPerIteration` parameter.

Click *OK* to save the new parameter and then *Commit* to save the changes. When you rerun the workflow, the output should now be as expected (*Figure 5.20*).

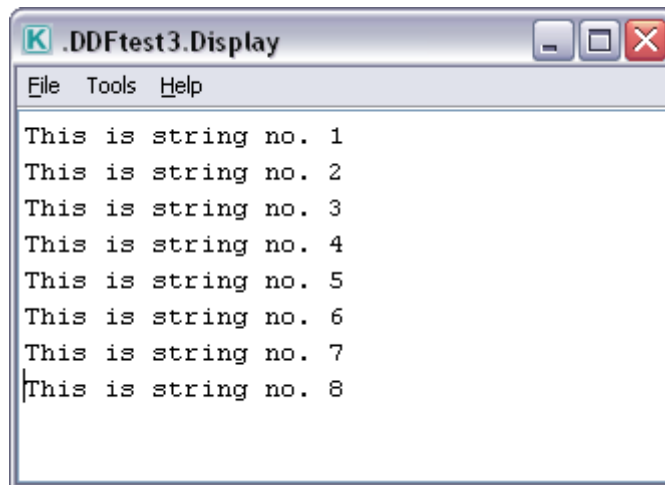

Figure 5.20: The output of the example workflow once a `requiredFiringsPerIteration` parameter has been added to the `BooleanSwitch` actor.

Alternatively you can

- 2) Turn on the *DDF Director's* `runUntilDeadlockInOneIteration` parameter. To turn on this parameter, double-click the director and check the box beside the parameter name (*Figure 5.21*).



Figure 5.21: Turning on the *DDF Director's* `runUntilDeadlockInOneIteration` parameter.

Once this parameter is on, the *DDF Director* will, for each iteration, repeat the basic iteration until deadlock is reached. Deadlock occurs when no active actors are able to fire because their firing rules are not satisfied. Running the workflow again with the `runUntilDeadlockInOneIteration` parameter selected will produce the expected results (*Figure 5.20*)

For more information about the *DDF Director*, see the [Ptolemy documentation](#). The Ptolemy site also has a number of useful [examples](#).

5.3 Using Existing Actors

Kepler comes with a standard library of over three hundred fifty actors that can perform tasks such as connecting to a database, executing a UNIX command, displaying images and maps, or transforming data from one type to another. Existing actors can be customized in several ways: via parameters, additional ports, and a user-defined label. See Chapter 3 for more information about these features.

Users can select and use actors from the standard component library, the Kepler Repository, or from collaborators who make actors available online or simply email a component for immediate use. The following sections discuss each of these options in greater detail.

5.3.1 Using Actors from the Standard Component Library

All actors that are included in the Kepler standard component library appear in the tree in the Components area. Double-click an actor directory to open it (or double-click an open directory to close it) and navigate to the desired component, or use the Search field at the top of the library to locate the component directly (see Section 4.5.2 for more information about searching for components). To search only the local library, make sure no Remote repositories are marked 'Search' in the Tools > Preferences > Components tab.

To use an actor from Kepler's standard component library, simply drag-and-drop the actor from the library onto the Workflow canvas. All of the actors in the library have been tested and are ready to be incorporated into workflows.

To read more about an actor before instantiating it on the Workflow canvas, right-click the actor and then click View Documentation (*Figure 5.22*). Kepler will open a documentation screen containing information about the actor.

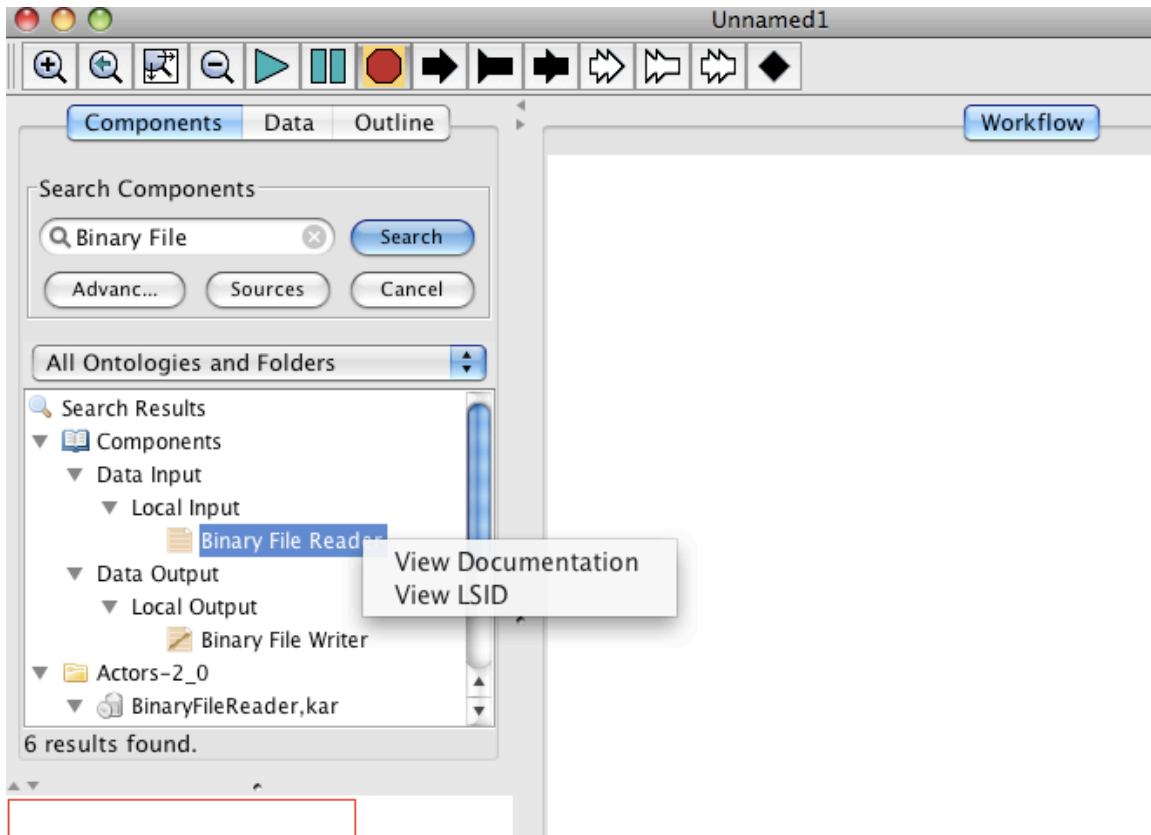

Figure 5.22: Viewing information about an actor in the Component library.

5.3.2 Instantiating Actors Not Included in the Standard Library

If you cannot locate a component in the standard library, but you know its class name—which might be the case with a Ptolemy actor that is not included in the standard library—you can instantiate the actor using the *Instantiate Component* item in the Tools menu (*Figure 5.23*). Instantiating an actor is the same as dragging an actor from the actor tree to the Workflow canvas. Components can be instantiated either with a class name or via a URL. Note that instantiation of an actor from a URL only works for Composite actors made from actors already in the standard actor library. Instantiated components will appear on the Workflow canvas.

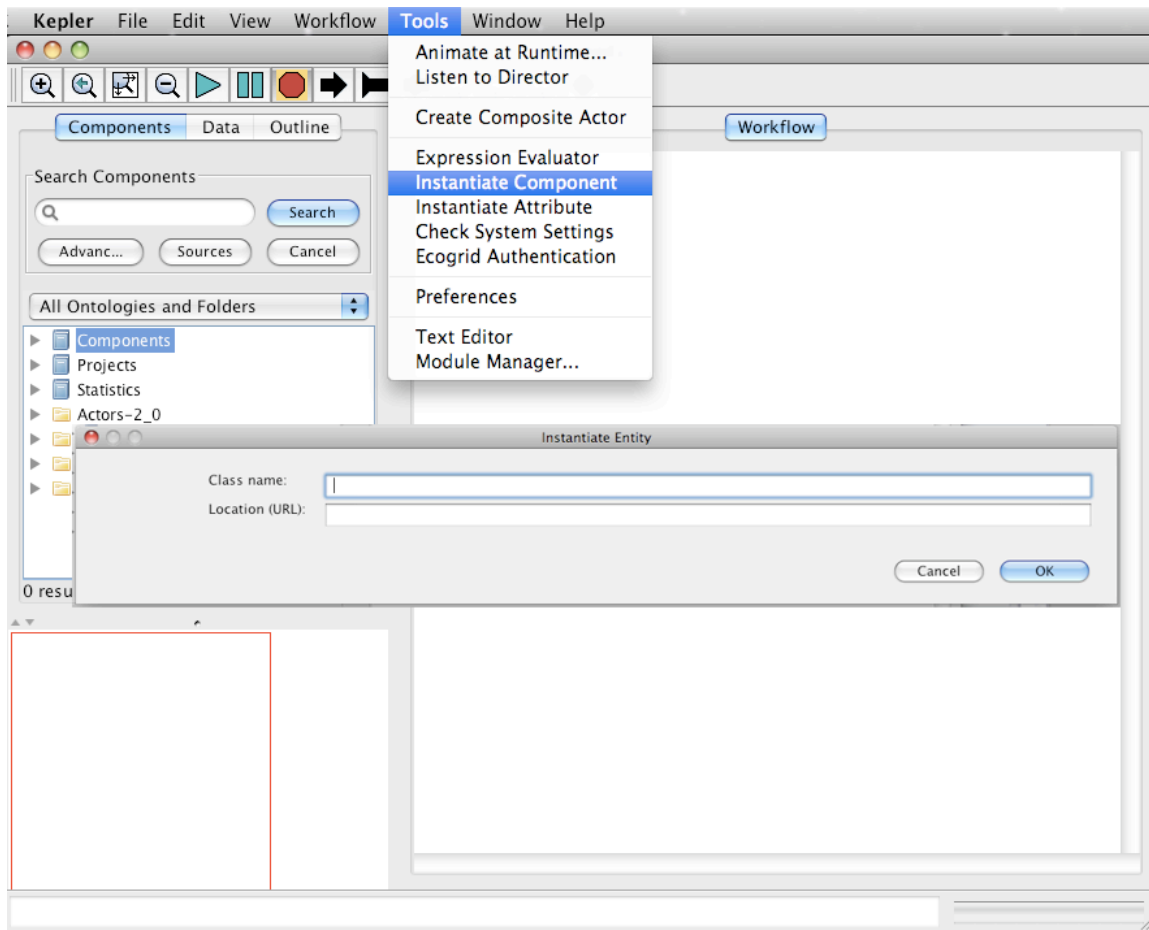

Figure 5.23: Instantiating a component via the Tools menu item.

The class name of each actor is displayed in the documentation. For example, to see the class name of the *Constant* actor, right-click the actor and select Documentation > Display (*Figure 5.24*).

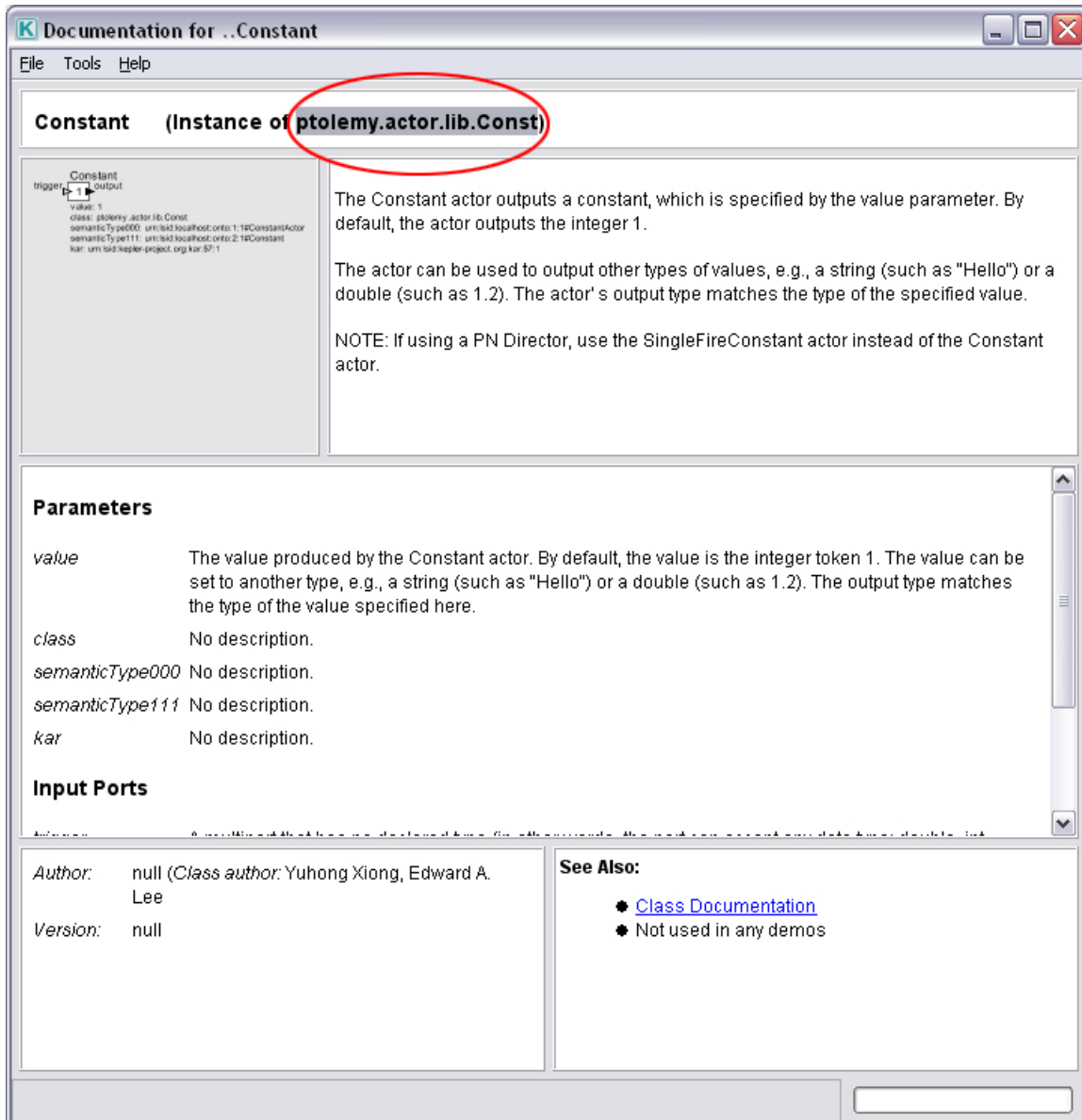

Figure 5.24: The class name of the *Constant* actor.

The online [Ptolemy code documentation](#) contains the actor class name near the top of each page (Figure 5.25). For example, use the class name `ptolemy.domains.ct.kernel.CTBaseIntegrator` to instantiate the *CTBaseIntegrator* actor on the Workflow canvas.

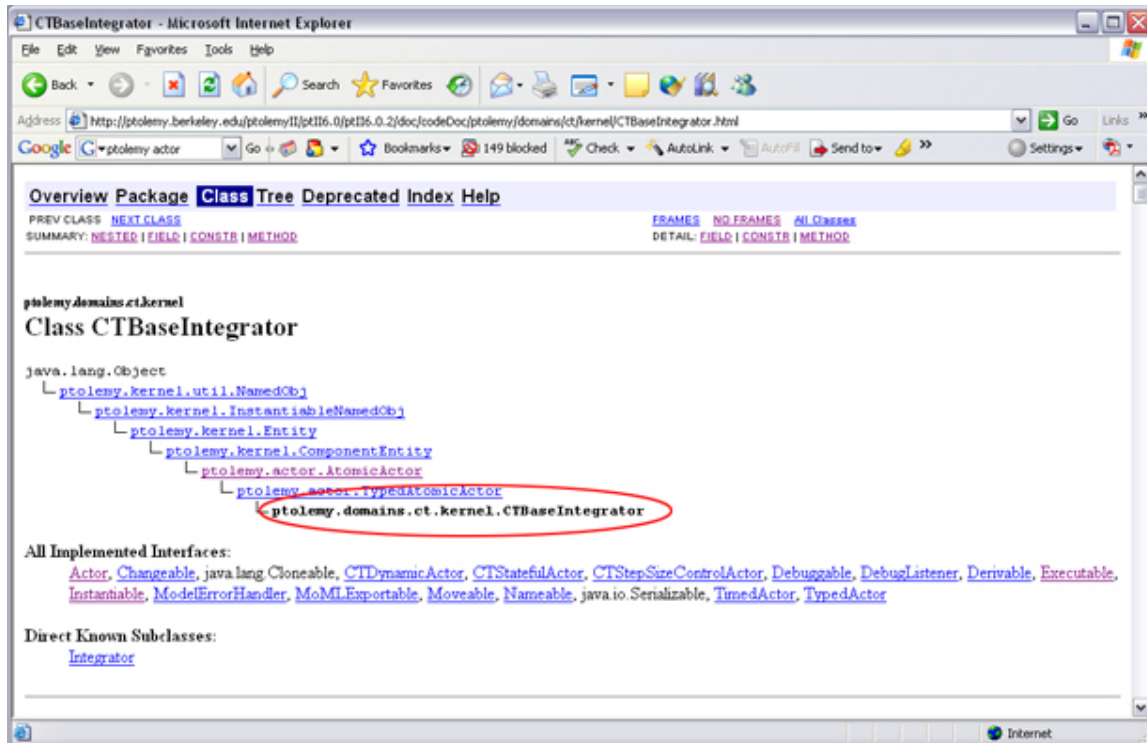

Figure 5.25: Online Ptolemy documentation contains the class name of each component near the top of each page. Use the class name to instantiate the component in Kepler.

Note that actors that are instantiated from the Tools menu are placed on the Workflow canvas, but are not added to the local library. See Section 5.3.5 for information about saving actors to the local library.

5.3.3 Using the Kepler Analytical Component Repository

The Kepler Analytical Component Repository contains components in a remote library hosted on the EarthGrid. Users can upload and download workflow components from this centralized server, and these components can be searched, downloaded (or uploaded), and used via the Kepler interface.

To search for components in the repository, first select the ‘remote’ repositories you’d like to search from the Tools > Preferences > Components tab, and then type the name of the required component in the search field (*Figure 5.26*). The component will automatically download when a user drags and drops the search result onto the Workflow canvas. If the found component is a KAR, it may be downloaded into your local ‘Save’ repository (also configured in the Components Preferences tab), and by default this is `KeplerData/MyWorkflows/`.

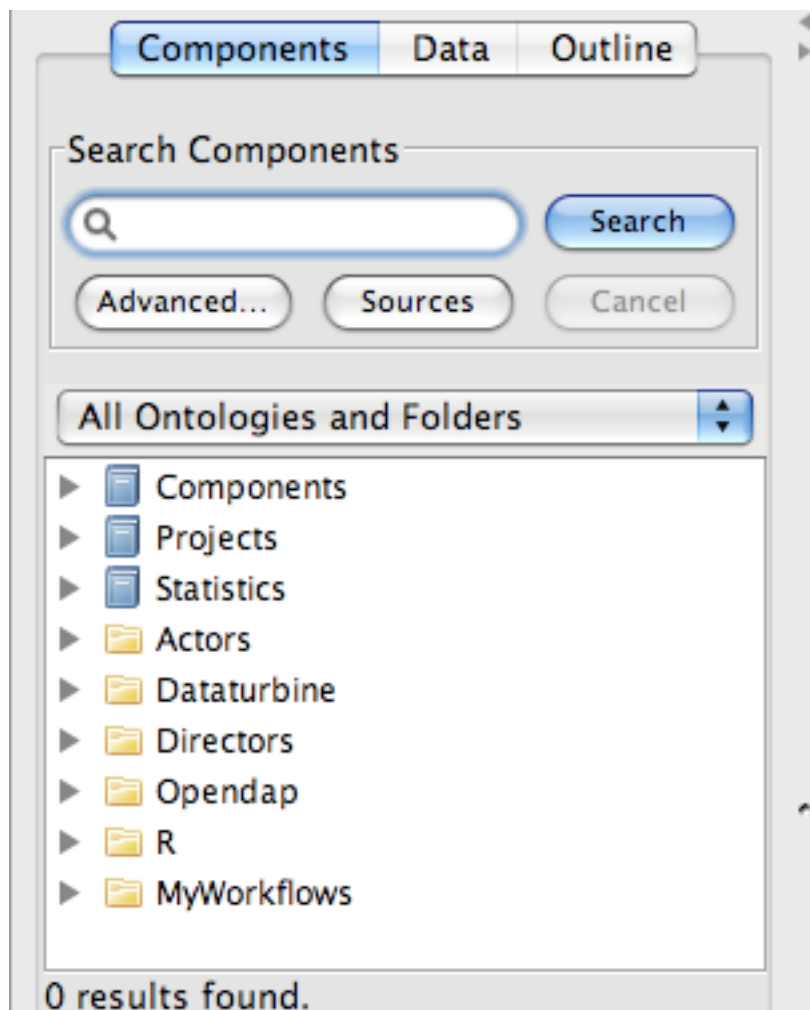

Figure 5.26: Search field for local and remote components.

Note that actors that are downloaded from the repository are instantiated on the Workflow canvas, but are not added to the local library. See *Section 5.3.5* for information about saving actors to the local library.

To add a new component to the repository where it can be used by other workflow designers:

1. Make sure that your actor has a unique and descriptive name. Right-click the actor and select *Customize Name* to supply a name.
2. Right-click the actor and select *Upload to Repository* from the menu (*Figure 5.27*). Enter a username, password, and organization OR, if you do not have a user account, click the *Login Anonymously* button to upload the actor without credentials. To obtain log-in credentials, please register for a KNB account at KNB.ecoinformatics.org.

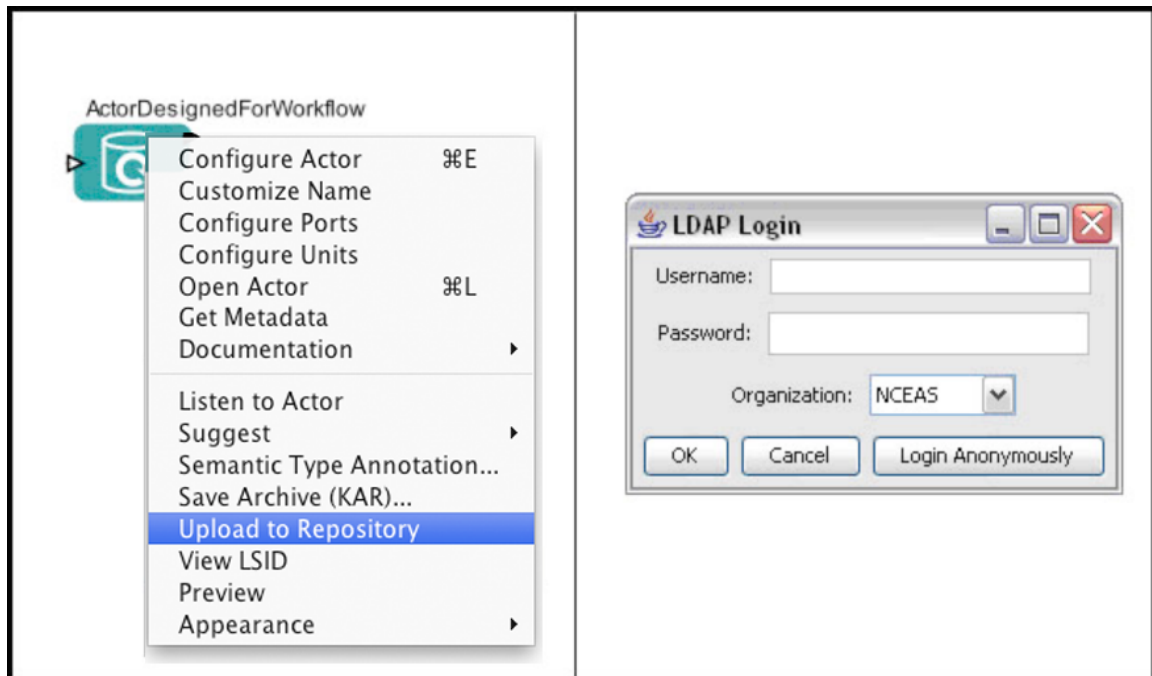

Figure 5.27: Uploading actors to the Kepler Repository. Right-click the actor and select the Upload to Repository menu item (left). Log in to the Kepler Repository using the pop-up authentication dialog (right).

3. Click "Yes" in the dialog box that asks whether the component should be publicly accessible in the library. Each component must have a unique Life Science Identifier (LSID), which identifies it. The system will automatically assign an LSID if necessary. A confirmation screen appears when the upload is complete.

5.3.4 Saving Actors to Your Library

The local Kepler library, which is accessed in the Components tab can be customized with additional actors and other components. To add actors to the local library, simply right-click the new actor and select “Save Archive (KAR)”. If the KAR file is saved into a configured local repository folder, e.g. the “MyWorkflows” directory, it will be displayed automatically in the actor library. (*Figure 5.28 and 5.29*).

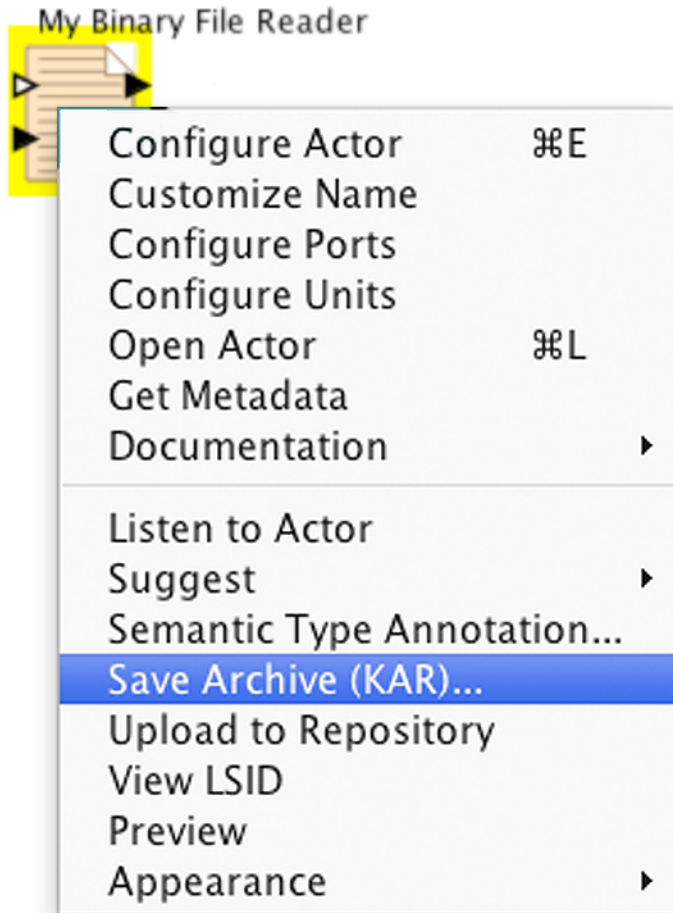

Figure 5.28: Saving an actor to your local library.

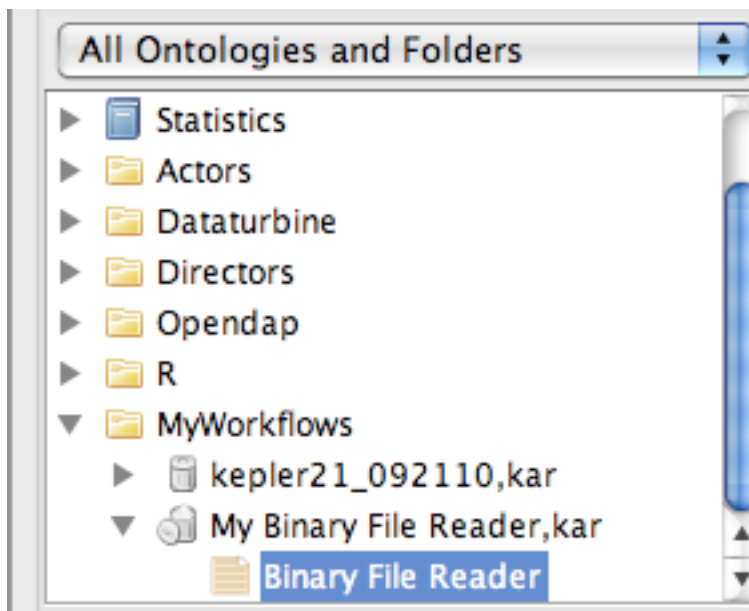

Figure 5.29: A modified *Binary File Reader* actor saved to the local library.

5.3.5 Importing Actors as KAR Files

Actors are stored as KAR (Kepler Archive Format) files, which allow them to be easily transported, shared and archived. To save an actor as a KAR file:

1. Right-click the actor on the Workflow canvas and select Save Archive (KAR)... from the menu.
2. Choose a save location and file name for the KAR file and click Save.
3. The actor will be saved as a KAR file. Note: if the actor has been compiled from new source code available only on the local machine, you must follow several additional steps when creating a KAR file. See the Appendix 1, Creating Your own Actor for more information.

KAR files can be emailed, posted on Web sites, or otherwise shared with other users. To open a KAR file into Kepler, use the Open... option of the File menu in the Menu bar.

5.3.6 Actor Icon Families

Each Kepler actor belongs to a family—a group of similar actors, often designated with a common icon or symbol. Some families, like Display or Math, contain sub-families, which are also identified with a common visual element. The actor icons, which appear in the Components area as well as on the Workflow canvas, identify the function of each actor.

Each icon can represent either an actor or a composite actor, depending on the number of teal "rectangles." In general, an actor is represented by a single teal rectangle and a composite actor is represented by two overlapping teal rectangles (*Figure 5.32*). Both actors and composite actors appear in the component library and can be used in workflows.

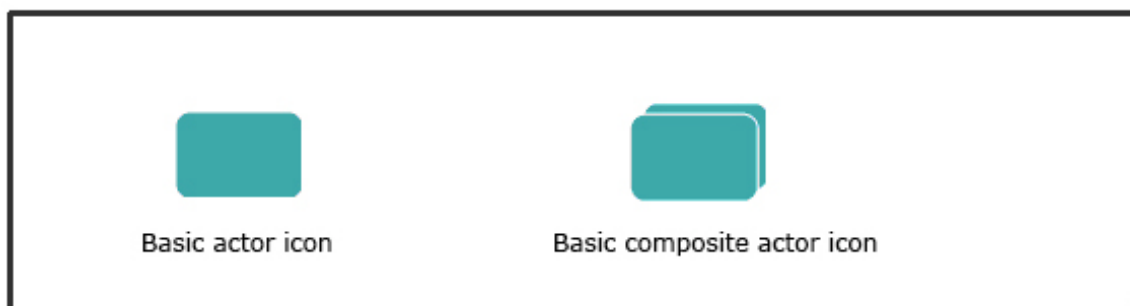



Figure 5.30: Basic actor and composite actor icons





The following table lists each actor family and sub-family, as well as the icon used to represent it.

Array	Array actors are indicated with a curly brace. Actors belonging to
--------------	---

	this family are used for general array processing (e.g., array sorting).	
	Array Accumulator	Array Accumulator actors read an array and output a string containing the array elements. Actors: <i>ArrayAccumulator</i>
	Array Average	Array Average actors read an array of values and output the average of the values Actors: <i>ArrayAverage</i>
	Array Contains	Array Contains actors read an array and determine whether a specified element is contained in it. The actors output a Boolean value: true if the element is contained in the array, false if not. Actors: <i>ArrayContainsElement</i>
	Array Dot Product	Dot Product actors read either two arrays or two matrices of equal length and compute and output their dot product. Actors: <i>DotProduct</i>
	Array Length	Array Length actors read an array and output the length of the array. Actors: <i>ArrayLength</i>
	Array Max	Array Max actors read an array of elements and output the value and the index of the largest element. Actors: <i>ArrayMaximum</i>
	Array Min	Array Min actors read an array of elements and output the value and the index of the smallest (i.e., closest to minus infinity) element. Actors: <i>ArrayMinimum</i>
	Array Sort	Array Sort actors read an array of values and output them in either ascending or descending order (e.g., from A to Z or Z to A). Actors: <i>ArraySort</i>
	General Array Processing	General Array Processing actors are used to perform a wide variety of array manipulations—from extracting a specified array element, to outputting the indices of peak array values. Actors: <i>ArrayElement</i> , <i>ArrayExtract</i> , <i>ArrayLevelCrossing</i> , <i>ArrayPeakSearch</i> , <i>ArrayRemoveElements</i> , <i>ArrayPermute</i>

Control	Control actors do not have a persistent family symbol. These actors are used to control workflows (e.g., stop, pause, or repeat).	
	General Workflow Control	General Workflow Control actors are used to stop, pause, delay, repeat, or branch a workflow. Actors: <i>Pause</i> , <i>Stop</i> , <i>Repeat</i> , <i>SampleDelay</i> , <i>Case</i> , <i>IterateOverArray</i> , <i>TokenToSeparateChannelsTransmitter</i> , <i>ThrowException</i> , <i>ThrowModelError</i> , <i>MessageDigestTest</i> , <i>NonstrictTest</i> , <i>Test</i> , <i>TypeTest</i>







Data/File	Data/File Access actors do not have a persistent family symbol.
------------------	--



Access	Actors belonging to this family read, write, and query data.	
	Data Access Support	<p>Data Access Support actors are generally used to open and close database connections, or to send commands to a data source.</p> <p>Actors: CloseDatabaseConnection, OpenDatabaseConnection, SRBConnect, SRBCreateQueryConditions, SRBCreateQueryInterface, SRBGetPhysicalLocation, SRBProxyCommands, PhyloDataReader</p>
	Data Query	<p>Data Query actors query data sources or metadata.</p> <p>Actors: DatabaseQuery, SRBQueryMetadata, TransitiveClosureDatabaseQuery</p>
 or	Reads/Gets/Sources	<p>Reads/Gets/Sources actors read data into a Kepler workflow: files, images, or data sets.</p> <p>Actors: BinaryFileReader, ExpressionReader, FileReader, FileToArrayConverter, ImageReader, LineReader, SimpleFileReader, NexusFileReader, EML2Dataset, OrbImageSource, OrbPacketObjectSource, SRBGetMetadata, SRBGet, SRBStreamGet, DataTurbine, OpendapDataSource</p>
	Read/Write	<p>Read/Write actors read and write data from host servers.</p> <p>Actors: FTPClient, EcogridWriter, DataGridTransfer</p>
 or	Write/Put/Sink	<p>Write/Put/Sink actors write data to output files or sinks, which store data for future use.</p> <p>Actos: BinaryFileWriter, FileWriter, LineWriter, TextFileWriter, OrbWaveformSink, OrbWaveformSource</p>

Data Processing	Data Processing actors do not have a persistent family symbol. Actors belonging to this family assemble, disassemble, extract, and convert data.	
	Data Processing	<p>Data Processing actors process data—converting data from one format to another or extracting specified values from a data set.</p> <p>Actors: ClimateChangeFileProcessor, ClimateFileProcessor, SProxy, ExperimentMonitor, XpathProcessor, XSLTProcessor, Interpolator, LookupTable, RecordAssembler, RecordDisassembler, RecordUpdater, VectorAssembler, VectorDisassembler, PolygonDiagramsDataset, PolygonDiagramsTransition, PAUPIInfer, RecIDCM3, TreeDecomposer, TreeImprover, TreeMerger, TreeParser</p>

Director	Stand-alone component that directs the other components (the
-----------------	---





actors) in their execution		
	Director	Each of the directors packaged with Kepler (SDF, PN, DDF, Continuous, CT, and DE) has a unique way of instructing the actors in a workflow. For more information about which director to use, see Section 5.2. Directors: CT Director, Continuous Director, DE Director, DDF Director, PN Director, SDF Director

Display	Display actors are indicated by vertical bars. Actors belonging to this family display workflow output in text or graphical format.	
	Array/Matrix Display	Array/Matrix Display actors accept matrix and/or array tokens and display them in a scrollable table format. Actors: MatrixViewer
	Browser Display	Browser Display actors read a file name or URL and display the file in the user's default browser. Some browser display actors allow users to interact with the displayed content during workflow execution. Actors: BrowserDisplay, BrowserUI
	GIS/Spatial Display	GIS/Spatial Display actors display geospatial data. Actors: ESRIShapeFileDisplayer, GMLDisplayer
	Graph Display	Graph Display actors plot data sets and display the results. Some of the actors use R, a language and environment for statistical computing and graphics. Graph Display actors that use R indicate so on the icon. Actors: ArrayPlotter, BarGraph, ENMPCP, SequencePlotter, TimedPlotter, TimedScope, XYPlotter, XYScope, Barplot, Boxplot, Scatterplot
	Image Display	Image Display actors display image files. Actors: ImageDisplay, ImageJ, ShowLocations, TreeVizForester
	Table Display	Table Display actors display information in tabular format.
	Text Display	Text Display actors display textual output. Actors: Display, MonitorValue

File Management	File Management actors do not have a persistent family symbol. Actors belonging to this family locate or unzip files, for example.	
	Directory Listing	Directory Listing actors read a local or remote directory name, and output an array of file and/or folder names contained by that directory. Actors: DirectoryListing
	File Locator	File Locator actors locate files from a file system.

	File Management	File Management actors copy, move, fetch, and put files and directories on local and remote hosts. Actors: DirectoryMaker, RandomDirectoryMaker, FileCopier, FileCopy, GenericFileCopier
	Zipped Files	The ZipFiles actor 'zips' multiple files into a single zipped archive. Actors: ZipFiles

GAMESS	GAMESS actors are used for computational chemistry workflows.	
	GAMESS Actors/Computational Chemistry	GAMESS actors perform a broad range of quantum chemical computations. For more information about GAMESS, see http://www.msg.ameslab.gov/GAMESS/ Actors: QMViewDisplay, Babel, OpenBabel, MoleculeSelector, GamessInputGenerator, GamessLocalRun, GamessNimrodRun, DataGroup, EndGamessInput, FormattedGroup, KeywordGroup, StartGamessInput, FileExistenceMonitor, FileListSequencer, FileLocationChooser, FileNameChooser, GamessAtomDataExtractor, GamessKeywords, MoleculeArrayProducer, TemporaryScriptCreator

General	Actors that don't fit into one of the other families fall into the General family. General actors include email, file operation, and transformation actors, for example.	
	Computation	Computation actors are used to perform calculations.
	Email	Email actors send email notifications from a workflow to a specified address. Actors: EmailSender
	Filter	Filter actors "filter" information, allowing users to select specific data from a data set. Actors: FilterUI
	Timers or Time	Timers or Time actors output the current time. Actors: CurrentTime, TimeStamp, CreateDate, DateDifference, DateToString, RandomDate
	Transformation	Transformation actors transform data from one type to another. Actors: URLToLocalFile, StringToXML, XMLToADNConverter, BooleanToAnything, ExpressionToToken, LongToDouble, ObjectToRecordConverter, TokenToExpression, TokenToStringConverter, UnitConverter, XMLToADNConverter, ConvertURLToImage, CartesianToComplex, CartesianToPolar, ComplexToCartesian, ComplexToPolar, PolarToCartesian, PolarToComplex, ArrayToElements, ArrayToSequence, ElementsToArray, SequenceToArray, StringToN

















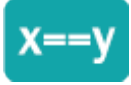





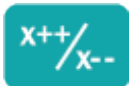

GIS/Spatial Processing	GIS/Spatial actors are used to process geospatial information.	
	GIS/Spatial Processing	<p>GIS/Spatial Processing actors are used to map and manipulate geospatial data.</p> <p>Actors: AddGrids, ConvexHull, CVHullToRaster, GDALFormatTranslator, GDALWarpAndProjection, Get2DPoint, GetPoint, GrassBuffer, GrassHull, GrassRaster, GridOverlay, GridRescaler, MergeGrids, PointInPolygon, PointInPolygonXY, Rescaler, StringToPolygonConverter, Interpolator, GARPPrediction, GARPPresampleLayers, GARPSummary, GridRescaler, GridReset, Rescaler</p>



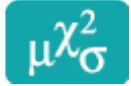

Image Processing	Image Processing actors have no persistent family symbol. Actors belonging to this family are used to work with graphics files.	
	Image Processing	<p>Image Processing actors are used to manipulate and convert image files.</p> <p>Actors: ASCToRaw, ConvertImageToString, IJMacro, ImageContrast, ImageConverter, ImageRotate, StingToImageConverter, SVGConcatenate, SVGToPolygonConverter</p>



Logic	Logic actors have no persistent family symbol. Actors in this family include Boolean switches and logic functions.	
	Boolean Accumulator	<p>The BooleanAccumulator actor reads a sequence of Boolean values and outputs one Boolean value from their combination.</p> <p>Actors: BooleanAccumulator</p>
	Boolean Multiplexor/Switch	<p>Boolean Multiplexor and Switch actors determine which of two or more input values to output. These actors are useful when creating workflow control structures, which allow workflows to branch, for example.</p> <p>Actors: Boolean Multiplexor, Switch</p>
	Boolean Switches	<p>The BooleanSwitch actor reads a value of any type and routes it to either a "true" or "false" port.</p> <p>Actors: BooleanSwitch</p>
	Comparator	<p>The Comparator actor reads two values and compares them. The actor outputs a Boolean value (true or false) that indicates whether the comparison criteria were met or not.</p> <p>Actors: Comparator</p>
	Equals	The Equals actor compares values to see if they are

		equal. Actors: Equals
	Is Present?	The IsPresent actor outputs "true" or "false" depending on whether it has received a data token or not. Actors: IsPresent
	Logic Function	The Logic Function actor performs a specified logical operation (e.g., "and" or "xnor"). Actors: LogicFunction
	Select	Select actors select and output a token from among received input tokens. Actors: Select, DDFBooleanSelect

Math	Math actors have no persistent family symbol. Actors in this family include add, subtract, integral, and statistical functions.	
	Absolute Value	The AbsoluteValue actor reads a scalar value (e.g., an integer, double, etc) and outputs its absolute value. Actors: AbsoluteValue
	Accumulator	The Accumulator actor outputs the sum of its received inputs. Actors: Accumulator
	Add or Subtract	The AddOrSubtract actor adds and/or subtracts received values. Actors: AddOrSubtract
	Average	The Average actor outputs the average of the values it receives via its input port. Actors: Average
	Constants	The Constant actor outputs a constant, a string or any other data type. Actors: Constant, StringConstant
	Counter	Counter actors increment or decrement an internal counter. Actors: Counter, TokenCounter
	Differential Equation	The DifferentialEquation actor reads differential equations, subtracts the current equation from the

		previously received one, and outputs the difference. Actors: DifferentialEquation
Stand-alone white box	Expression	The Expression actor evaluates an expression (e.g., an addition or multiplication operation) specified in the Ptolemy expression language. Actors: Expression
	Integral	The Integrator actor are used with the CT or Continuous directors to help solve ordinary differential equations (ODEs). Actors: Integrator, ContinuousIntegrator
	Limiter	The Limiter actor reads a scalar value and compares it to the top and bottom value of a specified range. Actors: Limiter
	Maximum	The Maximum actor reads multiple scalar values and outputs the maximum value. Actors: Maximum
	Minimum	The Minimum actor reads multiple scalar values and outputs the lowest value. Actors: Minimum
	Multiply or Divide	The MultiplyOrDivide actor multiplies and/or divides received values. Actors: MultiplyOrDivide
	Ramp Function	The Ramp actor is the equivalent of the "for loop" in many traditional computer languages. Actors: Ramp
	Random Number Generators	The Random actors generate or select one or more random values. Actors: Bernouli, DiscreteRandomNumberGenerator, GaussianDistributionRandomNumberGenerator, RicianDistributionRandomNumberGenerator, UniformDistributionRandomNumberGenerator, RandomNormal, RandomUniform, RandomDate
	Remainder	The Remainder actor receives an input value, divides the value by a specified divisor, and outputs the remainder. Actors: Remainder
	Round	The Round actor rounds a number using a specified rounding function.

		Actors: Round
	Scale	The Scale actor reads any scalar value that supports multiplication (e.g., an integer, double, array, matrix, etc), and outputs a scaled version of the value. Actors: Scale
	Signal Processing	Signal Processing actors generate or manipulate signals. Actors: Sinewave
	Statistics	Statistics actors organize and analyze data in a variety of ways. Actors: Quantizer, ANOVA, Summary, SummaryStatistics, Correlation, Regression, LinearModel, RMean, RMedian
	Trig Function	The TrigFunction computes a specified trigonometric function. Actors: TrigFunction

Other/External Program	Other/External Program actors are indicated by a purple rectangle. External Program actors include R, SAS, and MATLAB actors.	
	General External Program	General External Program actors execute UNIX commands or create UNIX shells from a workflow. Actors: ExternalExecution, InteractiveShell, SShToExecute, UserInteractiveShell
	R	R actors use R, a language and environment for statistical computing and graphics. Actors: ReadTable, Summary, RandomNormal, RandomUniform, ANOVA, Correlation, LinearModel, Regression, RMean, Rmedian, Rquantile, Summary, SummaryStatistics, Barplot, Boxplot, RExpression, Scatterplot

String	String actors have no persistent family symbol.	
	String	String actors are used to manipulate and work with strings in a variety of ways. Actors: StringAccumulator, StringCompare, StringLength, StringFunction, StringIndexOf, StringMatches, StringReplace, StringSplitter, StringSubstring, StringToInt, StringToLong, StringToN, StringToXML,

Units	Unit systems are indicated with a blue oval.	
	Units	Units are parameters that define a unit system that consists of a set of base and derived units. Actors: BasicUnits, CGSUnitBase, ElectronicUnitBase, SI



Utility	Utility actors have no persistent family symbol.	
	Utility	Utility actors help manage and tune a particular aspect of an application. Actors: VariableSetter, ExperimentPreparator, ExperimentStarter, ForkResourceAdder, TokenDuplicator, Recorder, GUIRunCIPRes, Initializer, SubsetChooserActor, TreeToString
Web Service	Web Services actors are indicated by a wireframe globe. Actors in this family execute remote services.	
	Web Service	Web Service actors are used to invoke a Web service, allowing users to take advantage of remote computational resources. Actors: ServerExecute, SoaplabAnalysis, SoaplabChooseOperation, SoaplabChooseResultType, SoaplabServiceStarter, WebService, WMSDActor

Table 5.1: Actor icons

5.4 Using Composite Actors

Composite actors, or actors that contain sub-workflows, are commonly used in Kepler. These actors—much like document outlines that can be opened or collapsed to show or hide increased levels of detail—simplify workflows by concealing some of the complexity. Composite actors are reusable components that perform a potentially complex task. The details of the process used to carry out the task are revealed when a user is interested in the minutia and elects to open the composite actor to view its inner workings.

Composite actors are easily spotted by the double teal rectangle that represents them on the Workflow canvas (*Figure 5.32*).

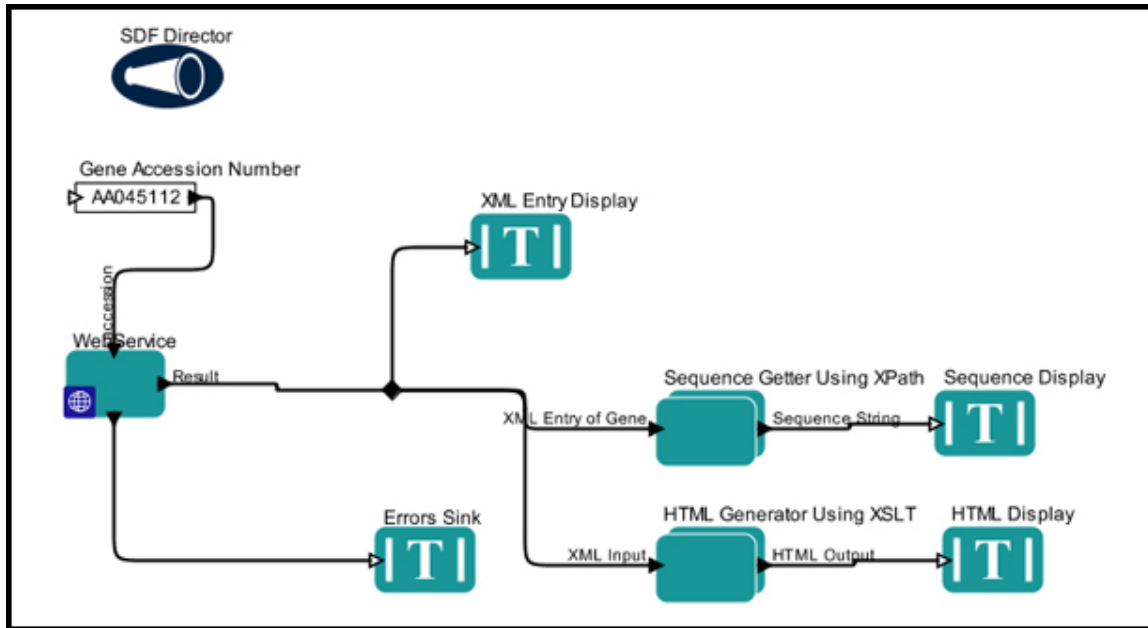

Figure 5.31: An example of a workflow that uses two composite actors (*Sequence Getter Using XPath* and *HTML Generator Using XSLT*). The above workflow, *6-WebServicesAndDataTransformation.xml*, is included with the Kepler release in the *demos/getting-started* directory.

The workflow in *Figure 5.32* uses two composite actors to perform workflow steps that are identified as "Sequence Getter Using XPath" and "HTML Generator Using XSLT". To see how the composite actor carries out these steps, simply right-click the composite actor and select *Open Actor* from the menu. A new application window opens, with the sub-workflow contained by the composite actor displayed on the Workflow canvas (*Figure 5.33*).

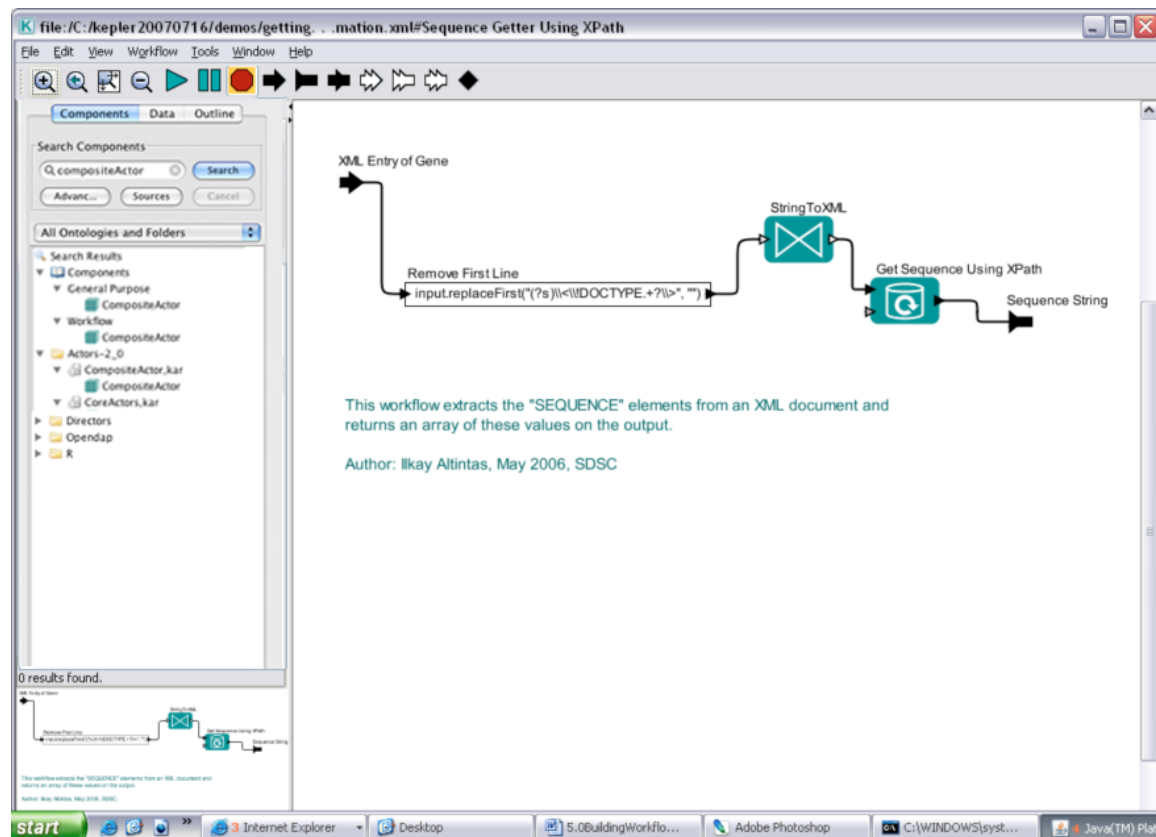

Figure 5.32: The inner workings of the *Sequence Getter Using XPath* composite actor.

5.4.1 Benefits of Composite Actors

In addition to simplifying workflows so that they can be more easily understood, composite actors bring a number of other benefits to Kepler: they can be easily reused and updated, they can be saved to the local component library or uploaded to the Kepler Repository where they can be shared, and they can contain other composite actors.

Scientists and other workflow designers can use composite actors to execute a task by combining existing analytical components rather than creating a new actor from scratch, which requires knowledge of Java. When composing composite workflows, scientists simply "wrap up" existing actors into a functional unit that performs a typical task.

Kepler uses two types of composite actors: opaque and non-opaque (or "transparent"). A sub-workflow that contains its own director is called an opaque composite. Non-opaque composites do not contain a director, and instead "inherit" their director from the containing workflow.

5.4.2 Creating Composite Actors

A composite actor can be created in one of two ways: either by dragging-and-dropping a *CompositeActor* from the component library onto the Workflow canvas and then customizing it, or by selecting existing components from the Workflow canvas and selecting Create Composite Actor from the Tools menu. We will go over both methods in this section.

To create a composite actor using the *CompositeActor*:

1. In the Components area, search for *CompositeActor*. Drag and drop the *CompositeActor* to the Workflow canvas.
2. Right-click the *CompositeActor* and select Open Actor from the menu. A new application window opens with a blank Workflow canvas (Figure 5.34). Use this canvas to construct the sub-workflow contained by the *CompositeActor*.

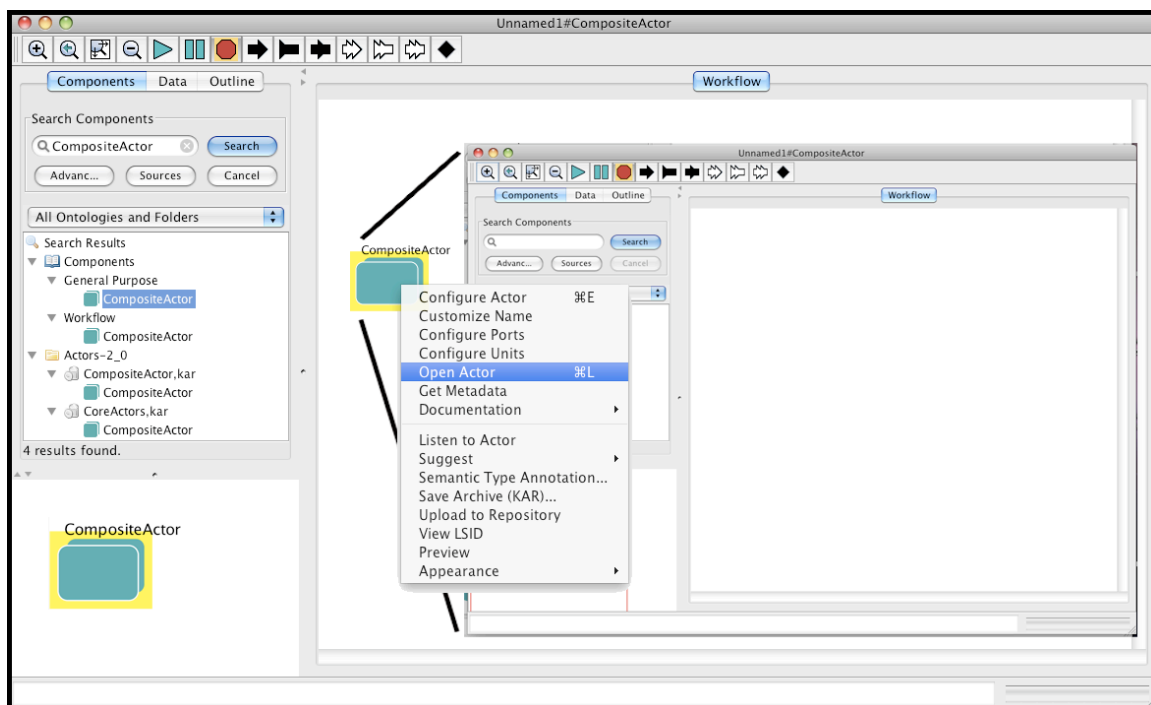

Figure 5.33: Right-click the *CompositeActor* and select Open Actor to open a blank Workflow canvas where the sub-workflow can be composed.

3. Drag and drop the components needed to compose the sub-workflow onto the *CompositeActor* Workflow canvas. Connect the components. The example in *Figure 5.35* contains a sub-workflow that can be used to add two constants and display the sum in a text window.

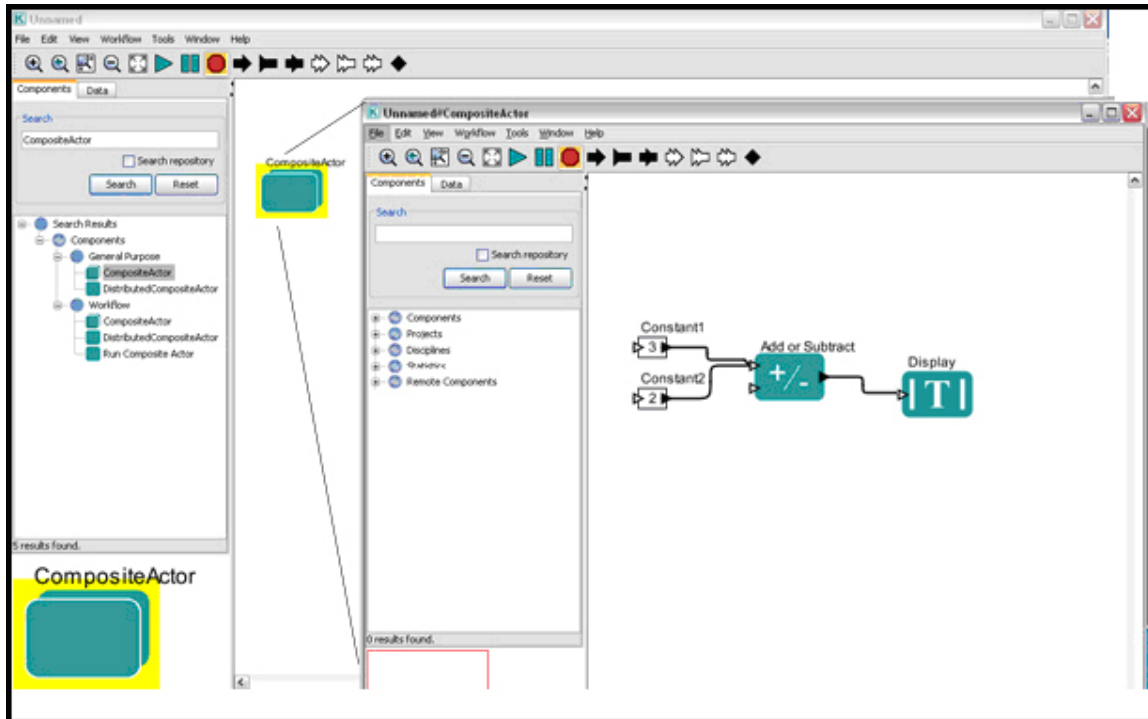

Figure 5.34: Adding a sub-workflow to a *CompositeActor*.

4. Once the sub-workflow has been composed, close the sub-workflow canvas. The sub-workflow can be accessed again by right-clicking the *CompositeActor* and selecting Open Actor from the menu.
5. Right-click the *CompositeActor* and select Customize Name from the menu. Select a unique and descriptive name for the Composite actor (e.g., *MakeSum*). Click Commit.
6. To add input and output ports to the *CompositeActor*, use the Add port buttons on the Toolbar (*Figure 5.36*). The port will appear on the Workflow canvas, where it can be connected to actors in the sub-workflow.

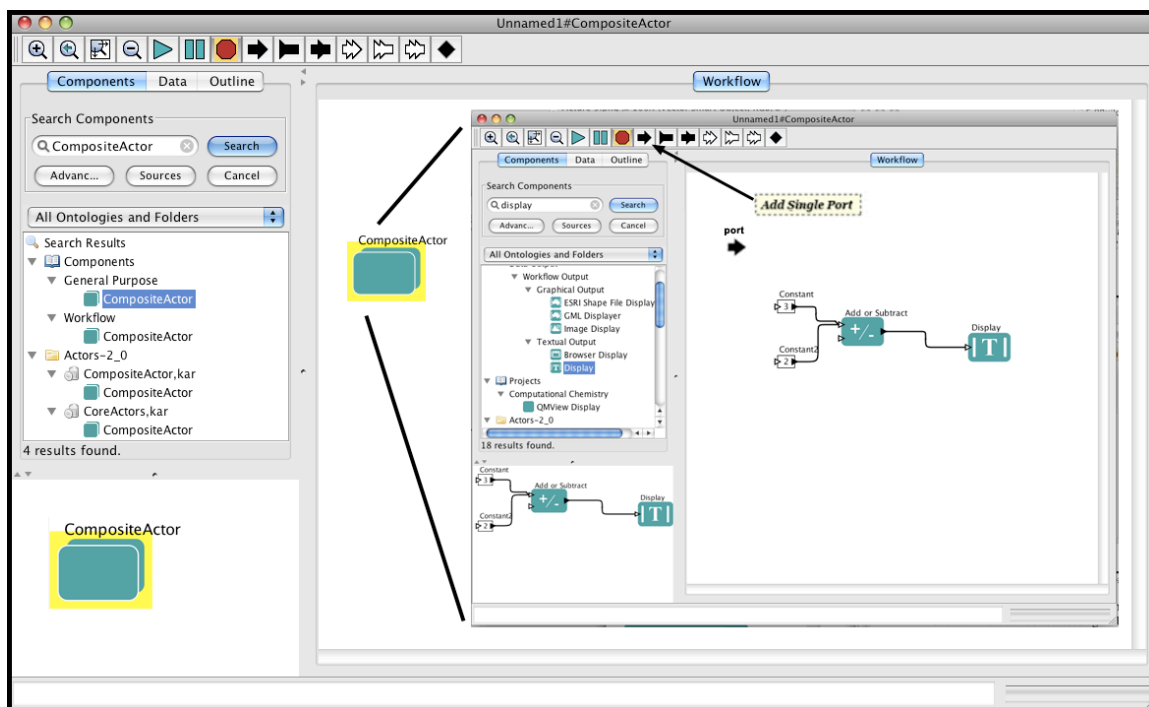

Figure 5.35: Adding ports to a composite actor.

- To name the port or otherwise customize it, right-click the *CompositeActor* icon and select *Configure Ports* from the menu (Figure 5.37). Click *Commit* to save the customization. The new name (e.g., *AddInteger*) will appear on the Workflow canvas of the sub-workflow.

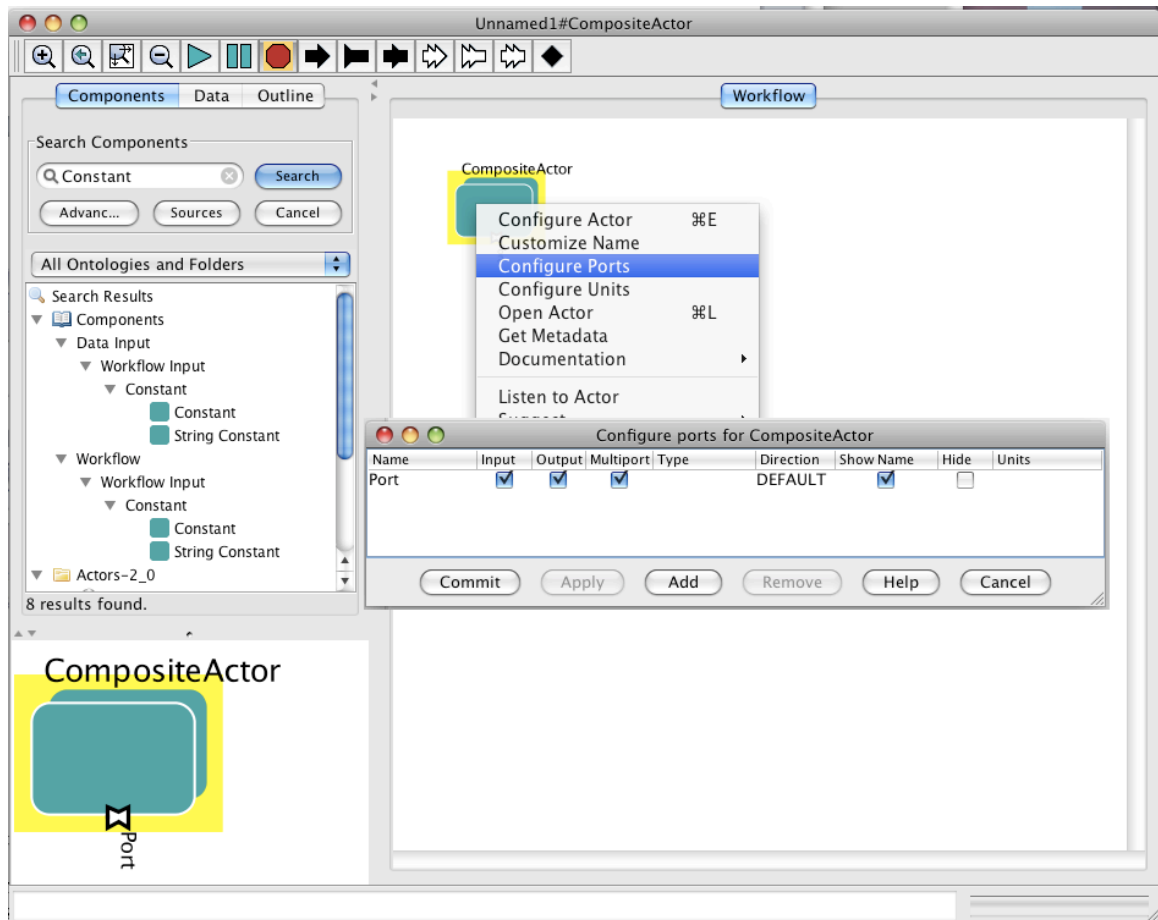

Figure 5.36: Customizing the ports of a composite actor.

8. To connect the new port, simply draw a channel between the port and an actor's input port (Figure 5.38). The port must also be connected to an actor in the containing workflow. Otherwise, an error may be generated.

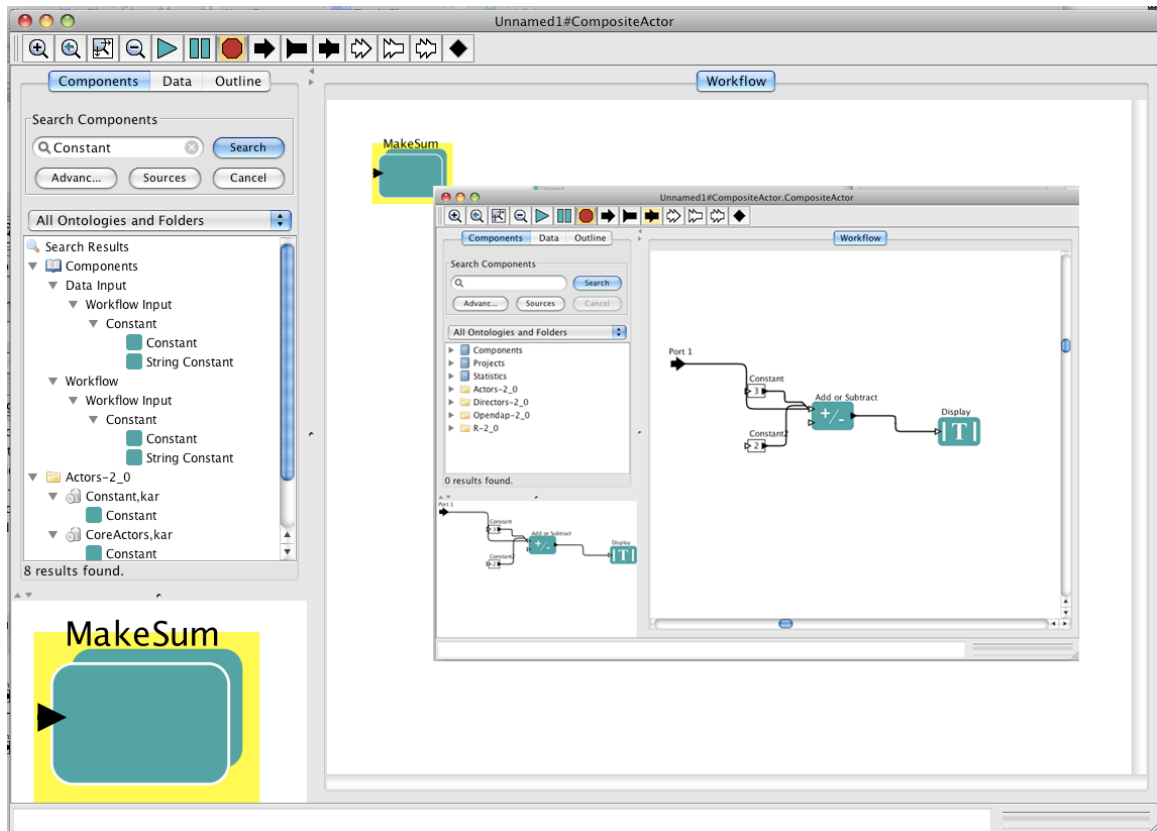

Figure 5.37: Connecting a port between a sub-workflow and a containing workflow. To complete the connection, the port must also be connected to an actor in the containing workflow.

9. The Composite actor can now be incorporated into a containing workflow. The simple example in *Figure 5.39* passes a constant (5) to the *MakeSum* composite actor, which adds the value, along with the two constants specified in the sub-workflow, and outputs the sum in a text window.

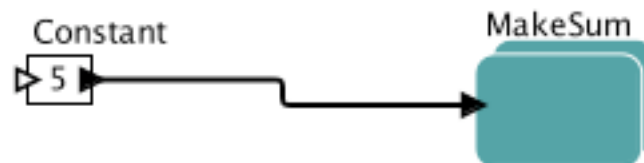

Figure 5.38: Using a composite actor in a containing workflow. This workflow outputs the sum of the constant passed to the composite actor (5) and the values specified in the sub-workflow (2 and 3).

To create a composite actor using the Create Composite Actor item under the Tools menu:

1. On the Workflow canvas, select the components you would like to include in the composite workflow. All selected components will have a yellow highlight.
2. Select Create Composite Actor from the Tools menu. A composite actor containing the highlighted components will replace them on the Workflow canvas (*Figure 5.41*).
3. Customize the name of the new composite actor and add ports to connect it to the existing workflow, or save the new composite actor to the local actor library by right-clicking the actor icon and selecting "Save Archive (KAR) ..." You will be prompted to assign a Semantic Type to the new composite actor. It will then be available for your use in the Component Library.

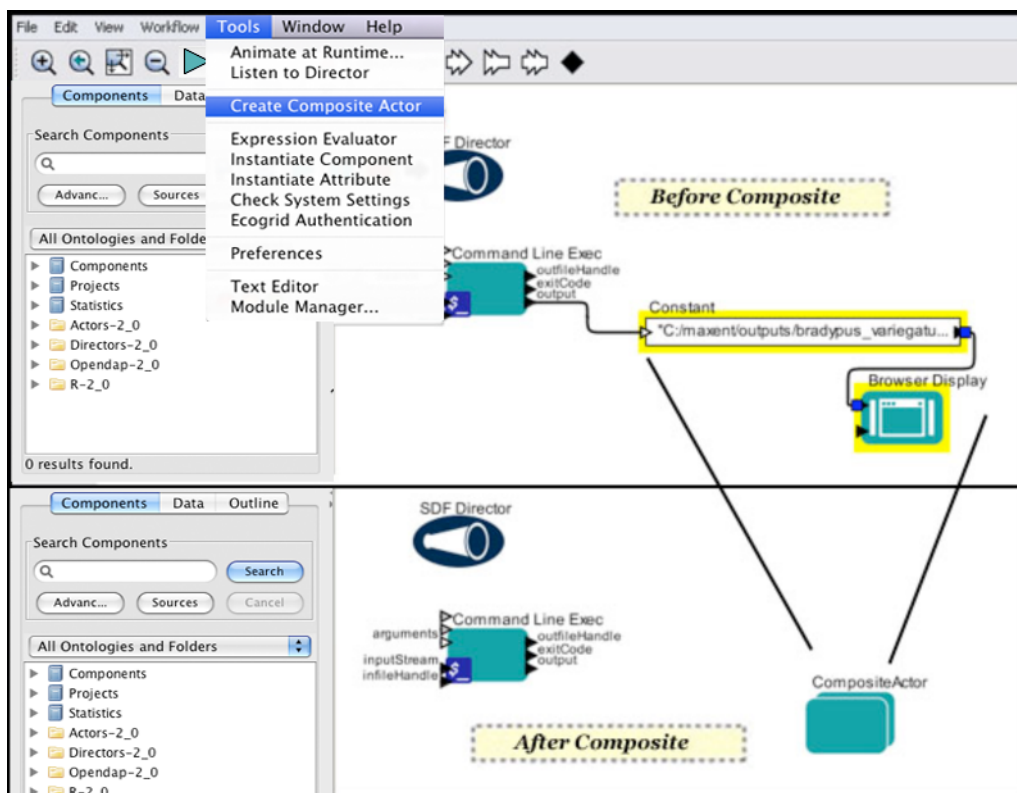

Figure 5.39: Creating a composite actor using the Tools > Create Composite Actor menu item.

5.4.3 Saving Composite Actors

Composite actors can be saved and shared just as other types of actors can be. In fact, saving a workflow as a composite actor is one of the simplest ways to transport and share workflows with colleagues. Simply paste a workflow into a composite actor to create a composite actor. Composite actors can be saved to the local system or the remote Kepler Repository, where they can be stored and shared.

To save a composite actor to the local system, right-click the actor and select "Save Archive (KAR)" from the menu. The composite actor will be saved in the Kepler Archive Format—as a single file that can be stored anywhere on the local system.

To adjust how an actor appears in the Ontologies, adjust its Semantic Annotations by right-clicking the actor and using "Semantic Type Annotation...".

To save a composite actor to the remote Kepler Repository, right-click the actor and select "Upload to Repository." The composite actor can be saved to the repository just like any other type of actor. See Section 5.3.4 for more information.

5.4.4 Combining Models of Computation

Opaque composite actors can be used to create workflows that combine models of computation (i.e., processes that require different directors). For example, a workflow that is managed by a CT Director can contain an opaque composite actor managed by a DE Director (such a workflow can be used for mixed-signal modeling). For more information about combining models of computation, see the [Ptolemy documentation](#).

5.5 Using the *ExternalExecution* Actor to Launch an External Application

The *ExternalExecution* actor can be used to launch an external application from within a Kepler workflow. The actor can pass values to the application and return values that can be used or displayed by downstream actors. In order to use the *ExternalExecution* actor, the invoked application must be on the local computer and, in some cases, configured appropriately. In this section, we will look at several examples of workflows that use the *ExternalExecution* actor.



The *ExternalExecution* actor is part of the standard Kepler library and can be found under "General Purpose/Unix Command" in the component tree or via a search under the Components tab.

5.5.1. Opening the HelloWorld Application

The workflow in *Figure 5.42* uses the *ExternalExecution* actor to open the HelloWorld application, a simple Java program that ships with Kepler. The HelloWorld application accepts an argument-- a user name (by default "Kepler_User")--and outputs the string "Hello Kepler-User!". This workflow can be found in the demos/getting-started directory (07-CommandLine_1.xml).

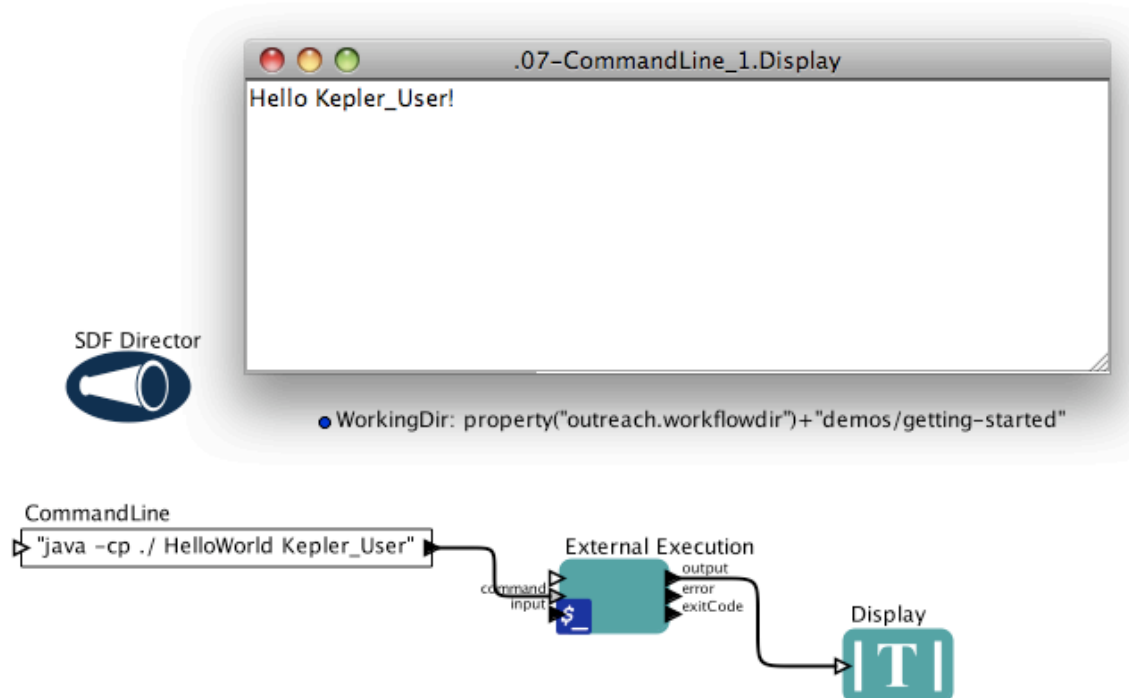

Figure 5.40: Using the *ExternalExecution* actor to launch the HelloWorld application.

The command to execute, "java -cp ./ HelloWorld Kepler_User", invokes the HelloWorld application (the "-cp ./" option instructs Java to use the current directory in the classpath). This command is specified by a *Constant* actor called *CommandLine* and passed to the *ExternalExecution* actor via the actor's *command* port. To change the output string from the default, "Hello Kepler_User!", to "Hello Bob!", simply update *Kepler_User* to "Bob".

The working directory—the place where the HelloWorld application will be executed—is specified via the actor's *directory* parameter. A workflow parameter, *WorkingDir*, specifies the name of the directory (property("outreach.workflowdir")+"/demos/getting-started"), and the *ExternalExecution* actor's *directory* parameter references this value ($\$WorkingDir$). Otherwise, the actor's parameters are left at their default settings (*Figure 5.42*).

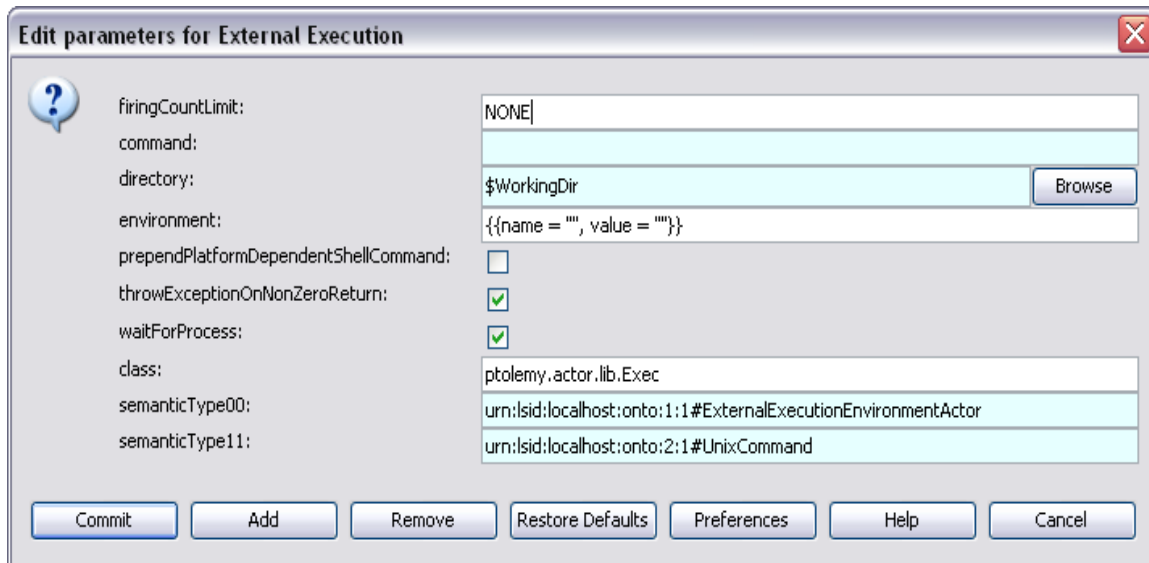

Figure 5.41: The parameters of the *ExternalExecution* actor.

The *ExternalExecution* parameters are used to customize the environment and output of the actor (*Table 5.1*).

Parameter	Purpose
firingCountLimit	Specify a positive integer to limit the maximum number of times the actor is executed.
command	The command string to execute (e.g., <code>ls</code> or <code>C:/Program Files/Internet Explorer/IEEXPLORE.EXE</code>) and, optionally, one or more arguments. The command can also be input via the actor's command port.
directory	The directory in which to execute the command. The default value of this parameter is <code>\$CWD</code> , which represents the user's current working or home directory.
environment	An array of records that name an environmental variable and a value: <code>{{name = "NAME1", value = "value1"}...}</code> Where <code>NAME1</code> is the name of the environmental variable, and <code>value1</code> is the value. For example <code>{{name = "PTII", value = "c:/ptII"}}</code> sets the value of <code>PTII</code> to <code>c:/ptII</code> . If the parameter is set to <code>{{name="", value = ""}}</code> , then the environment from the parent process is used. If environmental variables are set with the parameter, the parent values will not be passed to the process. To view the current environment, use the "env" command.

<pre>prependPlatformDependentShellCommand</pre>	<p>If this parameter is selected, the actor will preface the command with a platform-dependent shell command 'cmd.exe \c' (under Windows NT or XP) or Windows 95, the arguments 'command.com /C' under Windows 95 or '/bin/sh -c' (all other platforms). By default, the parameter is not selected.</p> <p>NOTE: This parameter must be selected if file redirection is used in <i>command</i></p> <p>NOTE: Under Cygwin, if true, the path environment of the subprocess is not identical to the path of the calling process.</p>
<pre>throwExceptionOnNonZeroReturn</pre>	<p>If selected, the actor will generate an error message if the invoked subprocess returns an error.</p>
<pre>waitForProcess</pre>	<p>Select to indicate that the command should finish executing before the actor outputs results. By default, the actor will stream command results as they are generated.</p>

Table 5.1: The *ExternalExecution* actor parameters.

5.5.2 Opening a Local Browser

A very simple example of a workflow that uses the *ExternalExecution* actor to open a browser window is shown in *Figure 5.43*. The location of the browser software, in this case `C:/Program Files/Internet Explorer/IEEXPLORE.EXE` for a Windows system (on a Mac, the location would be something like `/Applications/Firefox.app/Contents/MacOS/firefox`), is specified as the value of the *ExternalExecution* actor's `command` parameter (*Figure 5.44*). All other parameters are left at their default values.

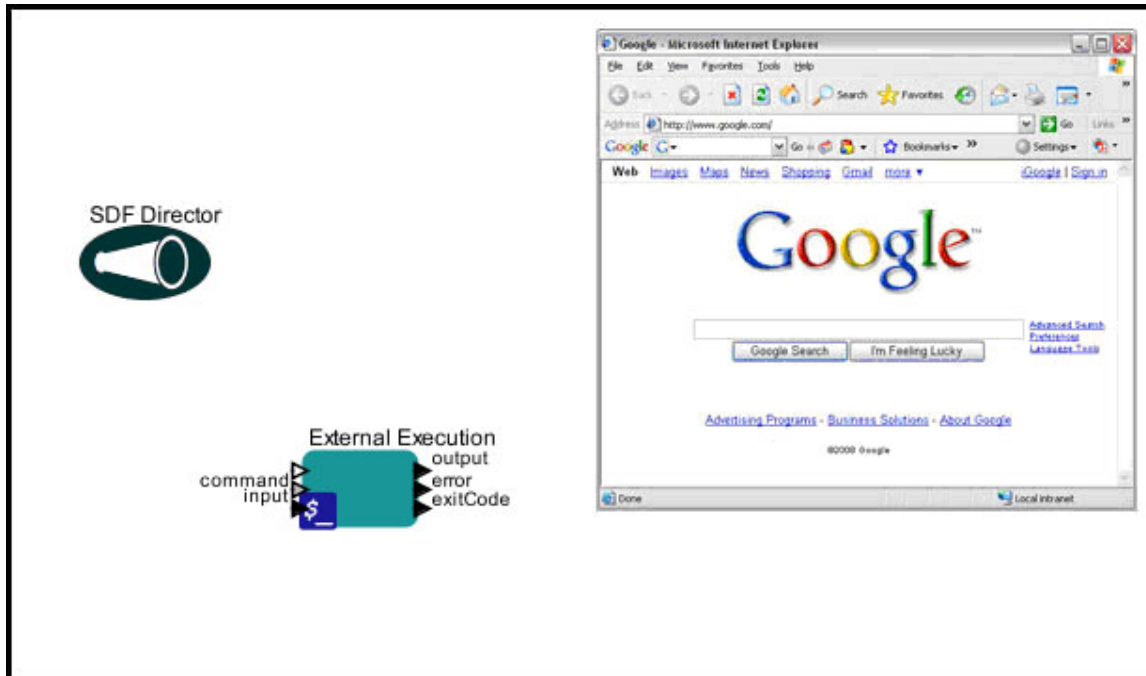

Figure 5.42: Using the *ExternalExecution* actor to open a browser window.

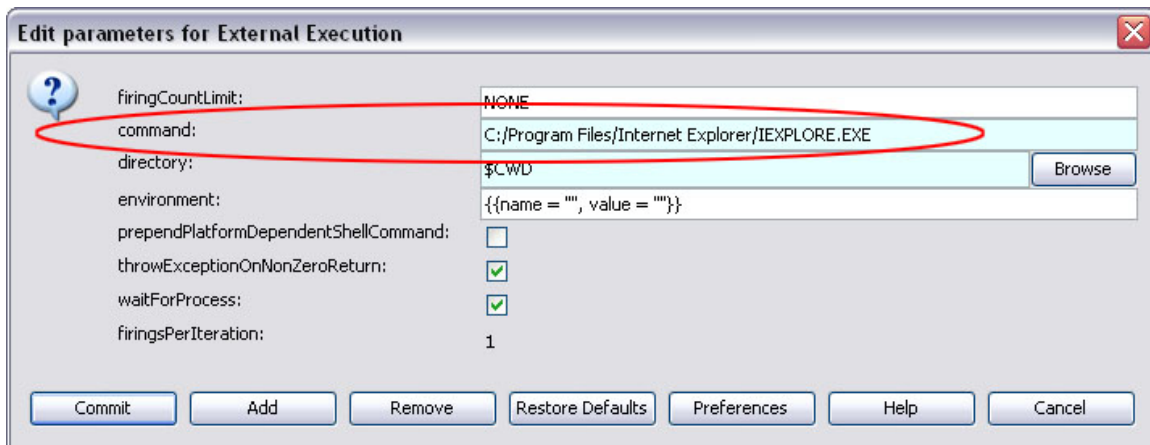

Figure 5.43: The location of the browser software is specified as the value of the `command` parameter. The other parameters are left at their default values.

5.5.3 Opening the Maxent Application

The workflow in *Figure 5.45* uses the *ExternalExecution* actor to launch the Maxent software (a Java application) from a workflow and to process a specified set of data. After the Maxent software has executed, Kepler's *BrowserDisplay* actor displays the HTML file that contains the results (*Figure 5.46*). In order to run the workflow, the Maxent software must be installed on the local system and properly configured. Instructions for downloading and customizing the software are included in this section.

Maxent software is based on the maximum-entropy approach for species habitat modeling. This software takes as input a set of layers or environmental variables (such as elevation, precipitation, etc.), as well as a set of georeferenced occurrence locations, and produces a model of the range of the given species. Maxent is written by Steven Phillips, Miro Dudik and Rob Schapire, with support from AT&T Labs-Research, Princeton University, and the Center for Biodiversity and Conservation, American Museum of Natural History.¹⁶

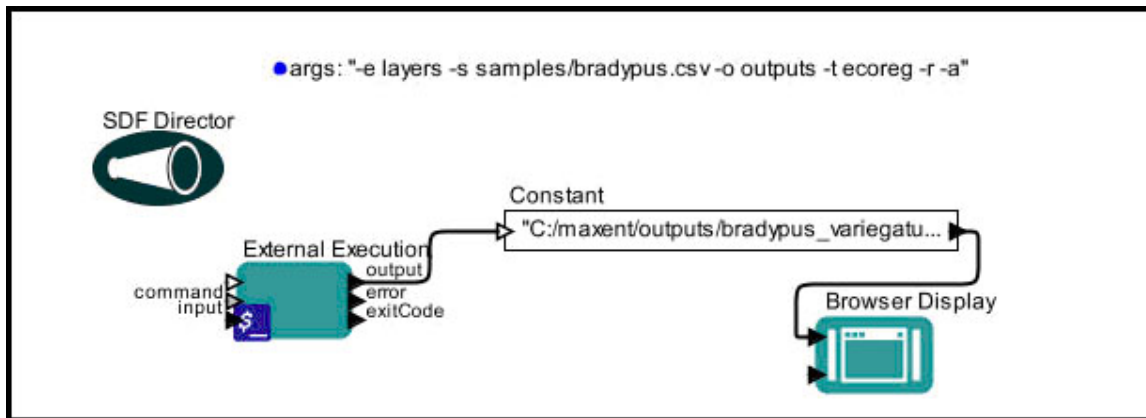

Figure 5.44: Using the *ExternalExecution* actor to invoke an application.

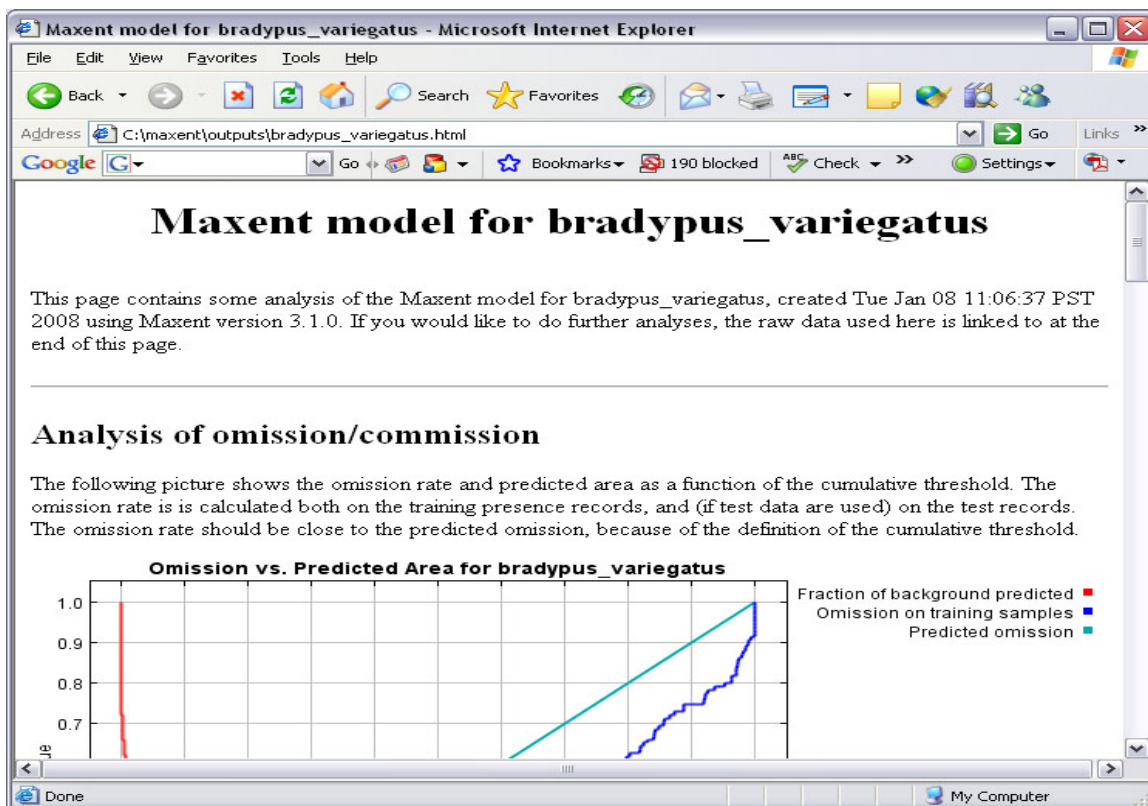

Figure 5.45: Output of workflow displayed in Figure 5.45. The *BrowserDisplay* actor displays the HTML results page generated by the Maxent software.

¹⁶ Maxent website, <http://www.cs.princeton.edu/~schapire/maxent/>

The Kepler workflow passes arguments to the Maxent software. These arguments, which are specified by a parameter (`args`), tell the software where to find the appropriate data files. In other words, if you run this workflow on your system, you must either ensure that your local data files are in the directories specified by the existing workflow arguments (or change the arguments to point to the location of your source data and match your existing configuration).

Before you can run a Kepler workflow to invoke Maxent, you must download and configure the software (if it's not already on your system). To set up your system:

1. Download and configure the Maxent software. Maxent can be freely downloaded from <http://www.cs.princeton.edu/~schapire/maxent/>. Place the `maxent.jar` and the `maxent.bat` file (if using Windows) in a directory called: `C:/maxent`
2. Download and unzip the sample data from the Maxent site: <http://www.cs.princeton.edu/~schapire/maxent/tutorial/tutorial-data.zip>

The sample data are contained in four directories:

`layers`: contains environmental data such as rainfall, etc.

`samples`: contains latitude/longitude occurrence location data for *Bradypus variegatus*, a three-toed sloth.

`outputs`: an empty directory that will be used for result files generated by the application.

`swd`: (not used in this tutorial)

3. Move the `"/layers`," `"/samples`" and `"/outputs`" directories so that the file paths are:
 - `C:/maxent/layers`
 - `C:/maxent/samples`
 - `C:/maxent/output`

The Maxent software and the data files needed to run the Kepler workflow are now in place.

4. Open Maxent and perform an example run by specifying the sample and environmental layer data as well as an output directory (*Figure 5.47*). Click RUN to execute. If you have trouble installing, running, or using Maxent, please see the [tutorials](#) on the Maxent site.

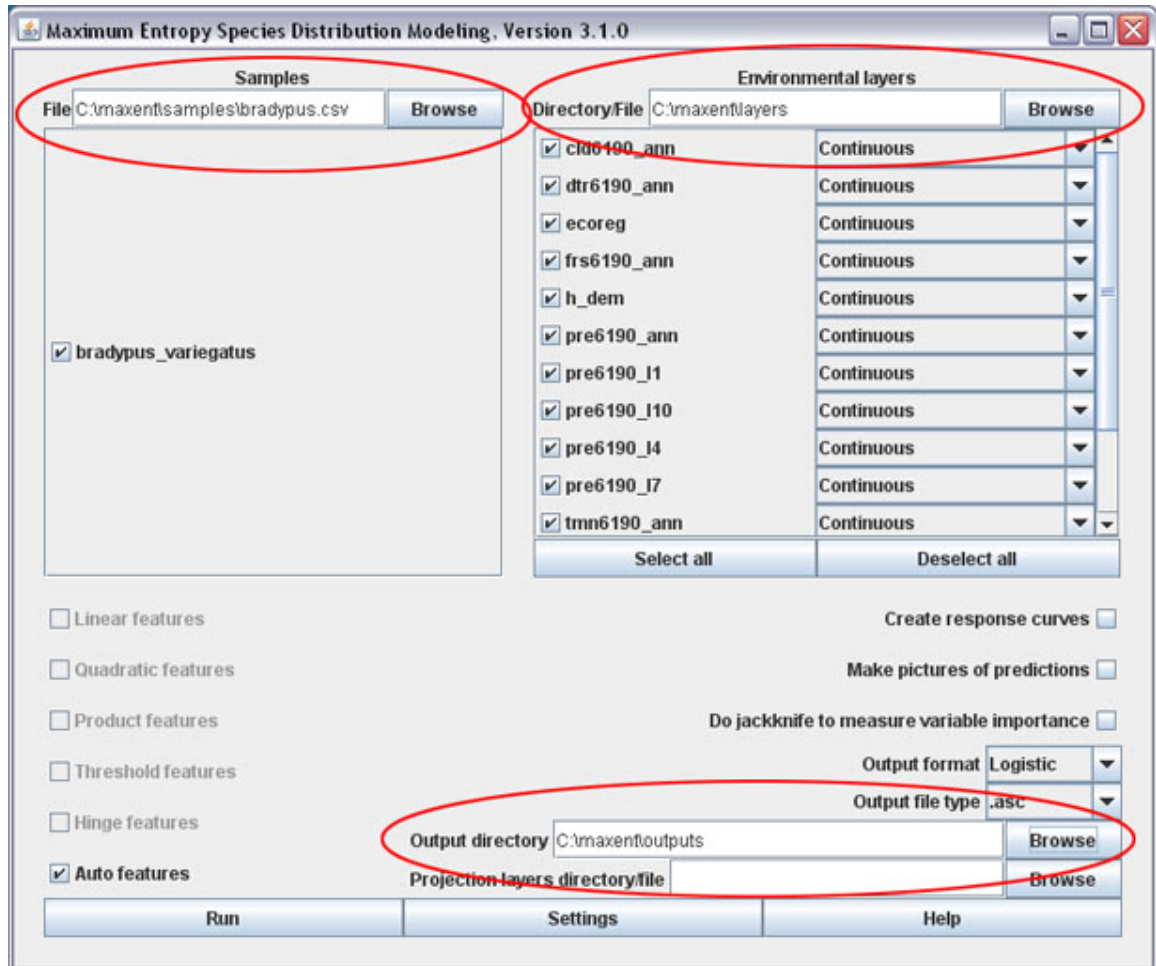

Figure 5.46: The interface of the Maxent software. Select sample and layer data as well as an output directory to perform a simple run.

When you click Run, Maxent processes the selected sample and layer data and generates a number of result files (including an HTML page of results) which are saved to the "C:/maxent/output" directory.

The Kepler workflow "recreates" all the steps just performed in the previous step: Kepler opens the Maxent software, specifies sample and layer data, as well as an output directory, and then runs the software. To create the workflow:

1. Drag and drop an *SDF Director* to the Workflow canvas. Set the director's `iterations` parameter to 1 to avoid calling the Maxent software multiple times.
2. Drag and drop a *Parameter* onto the Workflow canvas and specify the arguments that should be passed to the Maxent software (in this case, the location of the sample and layer files as well as the name of the output directory and the name of

the variable that is categorical (ecoreg). Paths are relative to the location of the invoked software). The parameter value is:

```
-e layers -s samples/bradypus.csv -o outputs -t ecoreg -r -a
```

Remember to enclose the parameter value in double quotes.

3. Rename the Parameter `args`. To rename the parameter, right-click its icon and select Customize Name from the drop-down menu.
4. Drag and drop a *ExternalExecution* actor onto the workflow canvas and customize its parameters (*Figure 5.48*):

- a. Specify the value of the `command` parameter. The `command` parameter contains a command to execute, in this case:

```
java -mx512m -jar maxent.jar $args
```

This command runs Java, specifies Java arguments (`-mx512m` specifies the megabytes of memory available to the program and `-jar` specifies that java is to be run from a Java Archive (JAR) file format), opens the Maxent software and passes it a string of arguments. `$args` references the value of the `args` parameter defined on the Workflow canvas. Note: arguments can also be included in a `.bat` file that is used as a command.

- b. Set the working directory to `c:/maxent/`
- c. Activate the `waitForProcess` parameter (if it is not already selected) by checking the box beside it. The actor will not produce output (i.e., a '1' on the `exitCode` output port if the execution is successful) until the Maxent software has completed processing. By default, the actor outputs results as they are processed.

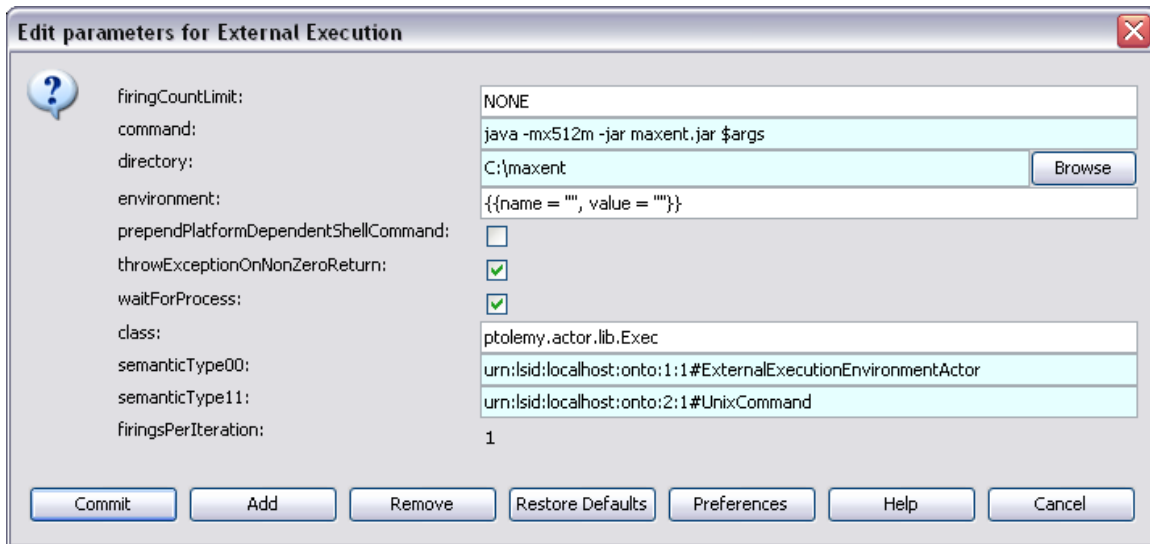

Figure 5.47: The parameters of the *ExternalExecution* actor.

5. Drag and drop a *Constant* actor onto the Workflow canvas and connect it to the output port of the *CommandLineExec* actor. Specify the location of the Maxent HTML result file as the value of the *Constant* actor:

```
"C:/maxent/outputs/bradypus_variegatus.html"
```

Note: The *Constant* actor will not output this location until it receives a trigger from the *ExternalExecution* actor.

6. Drag and drop a *BrowserDisplay* actor onto the Workflow canvas and connect its inputURL port to the output port of the *Constant* actor.

The workflow is now ready to run! After the Maxent software has executed, the results are saved to the `C:/maxent/output` directory and the *ExternalExecution* actor outputs a token that alerts downstream actors that it is done. A *Constant* actor specifies the location of the HTML file output by Maxent, and a *BrowserDisplay* actor opens the file and displays it in the default browser.

The *ExternalExecution* actor is part of the standard Kepler library and can be found under "General Purpose/Unix Command" in the component tree or via a search under the Components tab.

5.5.4 Opening R

The workflow in *Figure 5.50* uses the *ExternalExecution* actor to open the R application, with the `--no-save` option. The workflow passes a string `"q() \n"`, which

sends R a 'quit' function followed by a 'new line' (`'\n'`). This workflow can be found in Kepler's `/demos/getting-started` directory (`08-CommandLine_2.xml`).

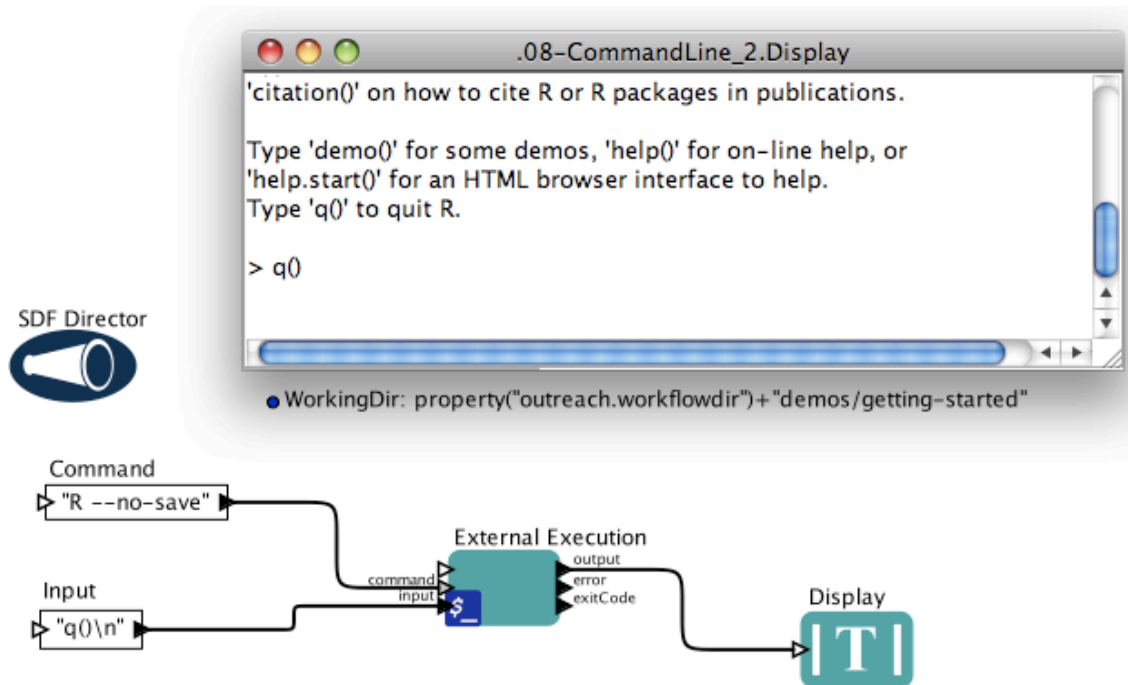

Figure 5.48: Using the *ExternalExecution* actor to open the R application.

The command to execute, `"R --no-save"`, which invokes the R application with the `"--no-save"` option, is specified by a *Constant* actor named *Command* and passed to the *ExternalExecution* actor via the actor's `command` port. The input, `"q()\n"`, is also specified by a *Constant* actor (*Input*).

The working directory—the place where the command will be executed—is specified via the actor's `directory` parameter. A workflow parameter, `WorkingDir`, specifies the name of the directory (`property("outreach.workflowdir")+"/demos/getting-started"`), and the *ExternalExecution* actor's `directory` parameter references this value (`WorkingDir`). Otherwise, the actor's parameters are left at their default settings (*Figure 5.51*).

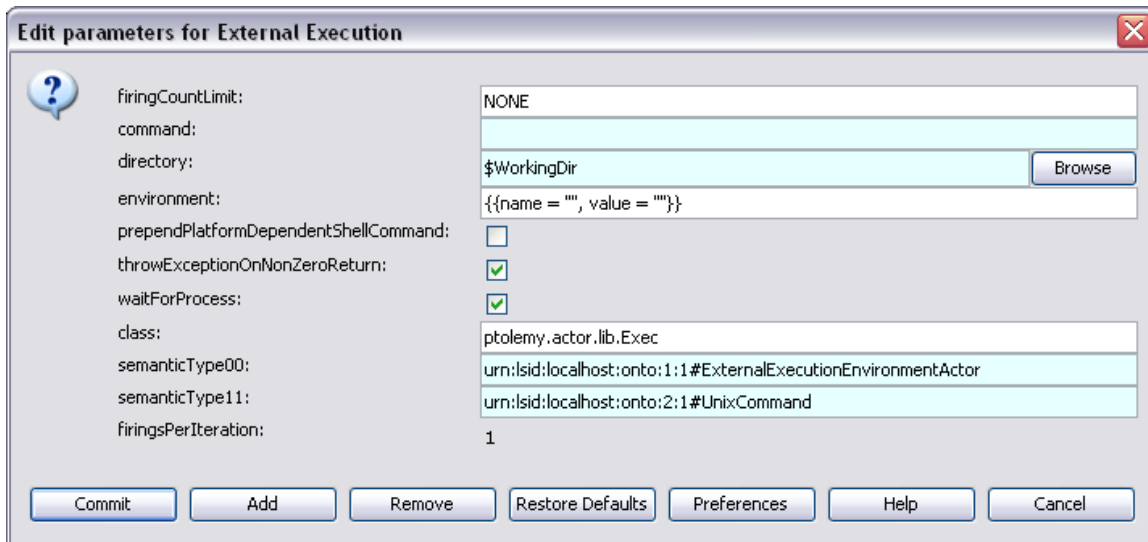

Figure 5.49: The parameters of the *ExternalExecution* actor, customized for the demos/getting-started/08-CommandLine_2.xml workflow.

5.6 Iterating and Looping Workflows

Creating a Kepler workflow to execute a task once is relatively easy: simply connect a series of actors and run the workflow. Creating a Kepler workflow that repeats that task a number of times, perhaps with different input data for each iteration, is somewhat more complicated. In more conventional programming languages like Fortran, C, C++, or Java, iteration is accomplished using a loop structure with an index that is incremented each time the body of the loop is executed. In a visual programming environment like Kepler, there are several ways of carrying out iterative calculations, most notably using:

- SDF iterations
- Ramp and Repeat actors
- array data objects
- higher-order composites
- feedback loops

Some of these techniques are more appropriate for feedback loops—iterating workflows in which each iteration depends on the output of the previous one. Others are more suited for iterating workflows in which the output of each iteration is independent of the previous one (repeating a process a number of times for different parameter values, for example). In this section, we will look more closely at each strategy for iteration and when each is most appropriate.

5.6.1 Iterating with the SDF Director

The simplest way to iterate a workflow is with the SDF Director's `iterations` parameter (Figure 5.52). By default, the `iterations` parameter is set to "0". Note that "0" does not mean "no iterations." Rather, "0" means that the workflow will iterate forever. Values greater than zero specify the actual number of times the director should execute the entire workflow. A value of 1 means that the director will run the workflow once (i.e., that the workflow will not be iterated).

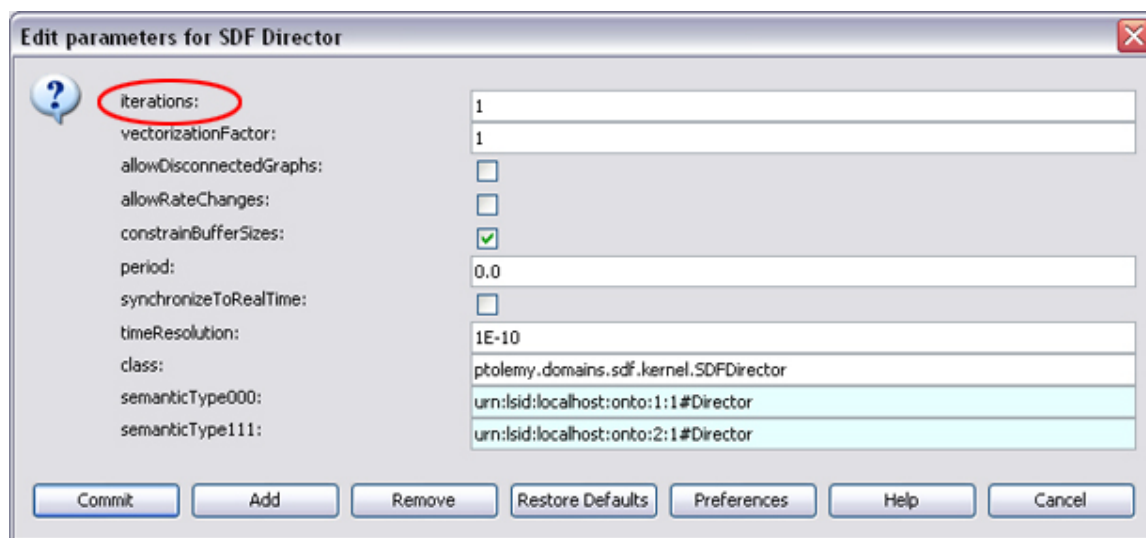

Figure 5.50: The *SDF Director*'s `iterations` parameter. Set the value to the number of desired iterations.

Setting the workflow iterations with the SDF `iterations` parameter is useful for cycling a workflow a number of times, provided that each iteration is independent (i.e., that the value of a given iteration does not depend on the output of any previous iterations). Workflows used to transform a series of values read from a data file are usually well-suited for this type of iteration. In this case, the `iterations` parameter can be set to the number of values in the data set. Choose an actor that can retrieve the desired input for each iteration (e.g., a *LineReader* actor).

The portion of a workflow displayed in Figure 5.53 uses a *LineReader* actor to read a data table that contains a Species name and the URL of a data file that contains information about locations in which the species has been found (the complete workflow can be found under `demos/ENM/GARP_MultipleSpecies-V.xml`). The *LineReader* actor outputs one line of data each time the workflow iterates.

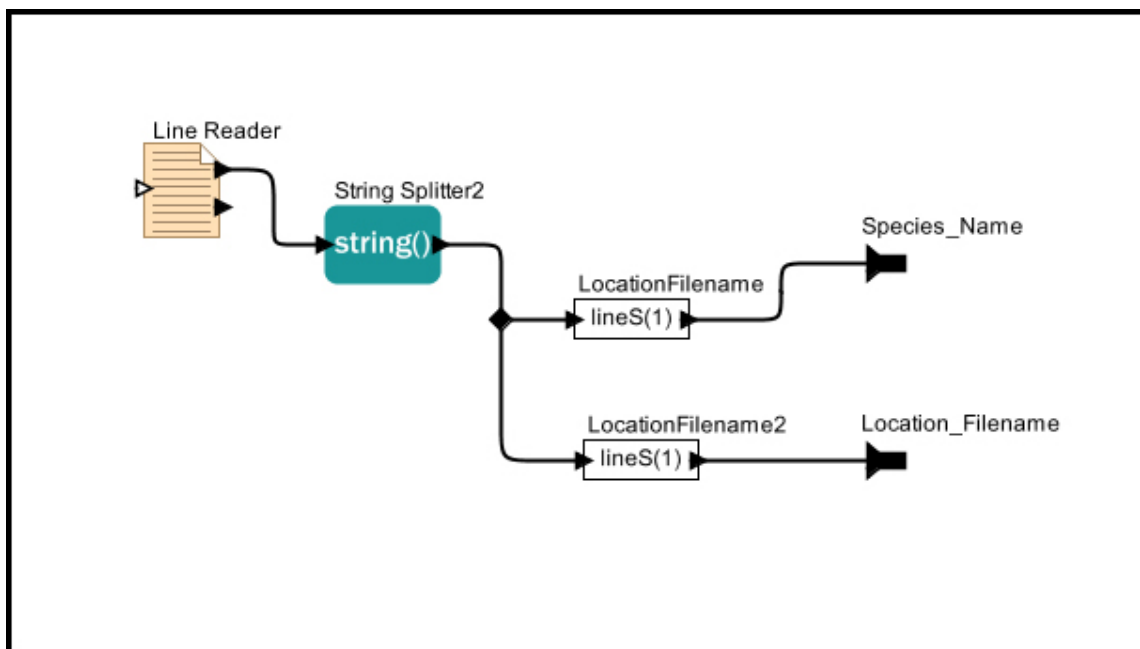

Figure 5.51: A simple workflow that could use SDF iterations parameter to control the number of workflow iterations.

The workflow uses a sample dataset that contains two records (KeplerData/workflows/module/outreach-2.X.Y/data/garp/speciesList.txt). The original data looks like this:

```
Mephitis,digir_data_mephitis.dat
Zapus,digir_data_zapus.dat
```

Each time the workflow iterates, the *LineReader* actor reads and outputs one line of data, and the workflow outputs the corresponding species name and data file.

5.6.2 Using Ramp and Repeat Actors

The standard Kepler component library includes several actors that can be useful when iterating a workflow or a portion of a workflow: the *Ramp* actor is used much like a "for loop", which executes a task a set number of times; and the *Repeat* actor can be used to repeatedly output a specified value. The *Ramp* actor is particularly useful when iterating a PN-directed workflow, as there is no way to set the number of iterations with a Director parameter.

The *Ramp* actor controls iterations via its parameters: `firingCountLimit`, `init` and `step` (Figure 5.53). The `firingCountLimit` parameter sets the number of times the actor should iterate. The actor keeps track of the iterations, incrementing its index every time an iteration is performed. The initial value of the index, as well as the amount that the index is incremented is set with the `init` parameter and the `step`

parameter, respectively. Each time the actor fires, it outputs the value of its index (an integer).

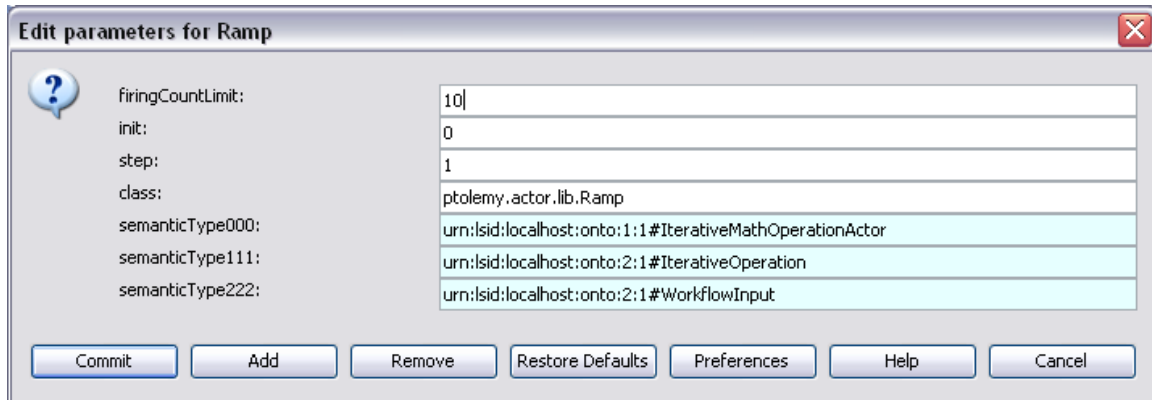

Figure 5.52: The parameters of the *Ramp* actor, which can be used like a "for loop" in a workflow.

The *Ramp* actor's output can be used as a counter (increasing, or decreasing if the *step* is set to a negative integer). The output is also commonly used to generate unique values as a workflow iterates. For example, the *Ramp* actor's index value can be used to generate a unique file name for each iteration (e.g., 'file1', 'file2', etc.) (*Figure 5.54*).

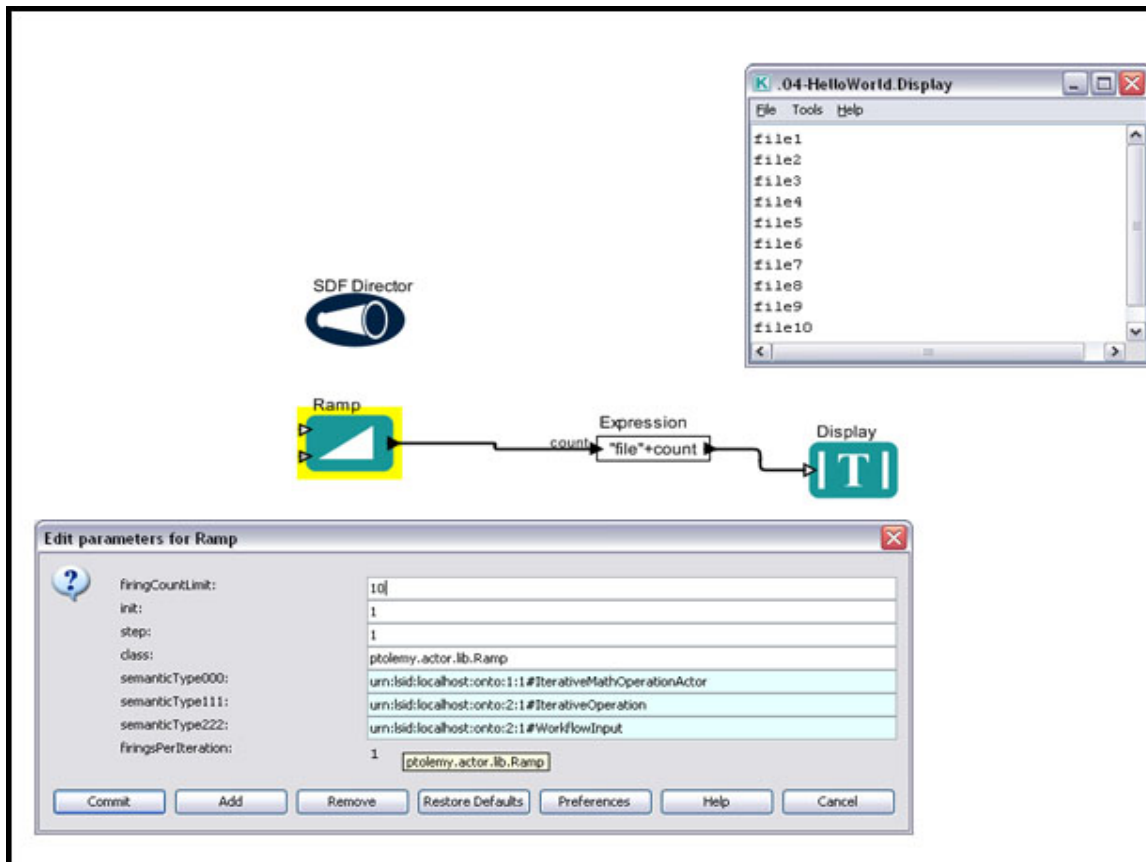

Figure 5.53: The *Ramp* actor used with an *Expression* actor to generate a unique file name each time the workflow iterates. The window in the upper-right displays the workflow output (the ten unique names generated by the workflow).

The simple workflow in *Figure 5.54* generates a unique file name each time the workflow iterates (ten times, as specified by the SDF Director's *iteration* parameter). Each time the workflow iterates, the *Ramp* actor increments its index by the value of its *step* parameter and outputs the new value. Note that an input port named *count* has been added to the *Expression* actor. The *Expression* actor references the value passed to this port with the specified expression ("file"+count).

One common problem with iterating a workflow multiple times appears when only one "branch" of a multi-branch workflow changes with each iteration. For example, an actor in an iterated workflow may require two inputs: one input that changes with every iteration (a counter or a value to process), and one that remains constant. If the constant value is a simple integer or string, then repeatedly generating that value adds little overhead to the workflow; however, if the constant value requires time-intensive processing to generate, then repeating the calculation each time the workflow iterates will significantly increase the workflow processing time. Use a *Repeat* actor, which reads an input token and duplicates it a specified number of times, to avoid this type of redundant calculation.

For example, the workflow fragment in *Figure 5.55* uses two *Repeat* actors to duplicate the inputs that the *Calculate Omission/Commission* actor receives. In this case, both inputs remain constant because the Omission/Commission calculation is probabilistic and the *Calculate Omission/Commission* actor is designed to repeat a calculation on the same set of inputs.

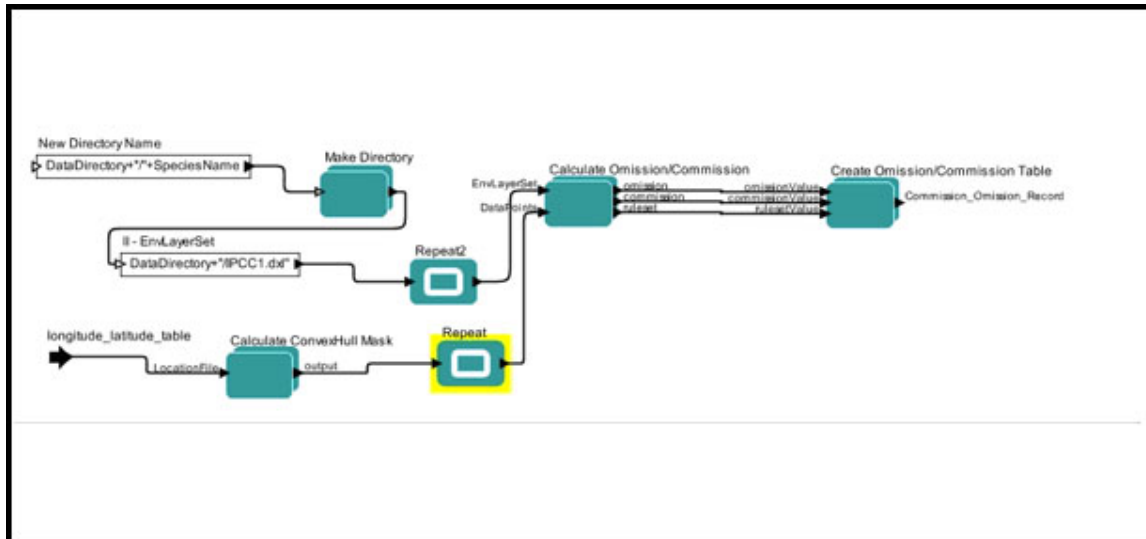

Figure 5.54: A fragment of workflow that uses *Repeat* actors to avoid redundant calculations. The full workflow can be found at [demos/unsupported/ENM/GARP_SingleSpecies_BestRuleset-IV.xml](#).

The `numberOfTimes` parameter for both *Repeat* actors is set to the number of workflow iterations (*Figure 5.56*). In this case, the value of the parameter refers to the value of a parameter (`numIterations`) specified on the Workflow canvas.

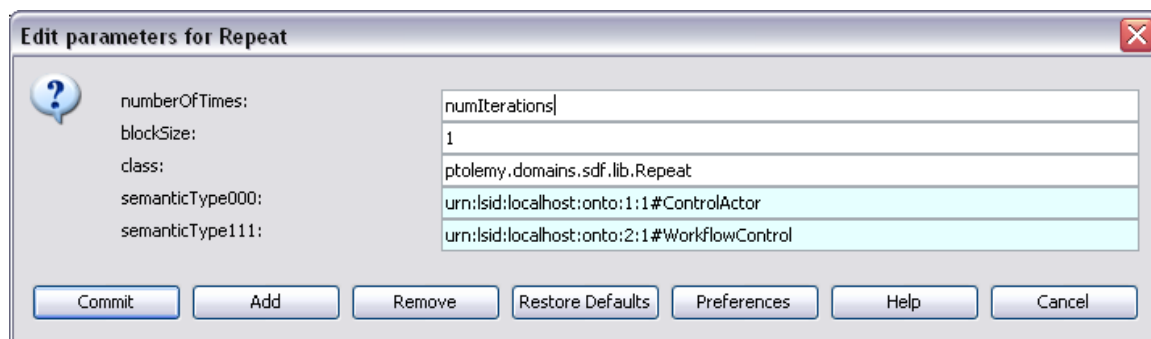

Figure 5.55: The parameters of the *Repeat* actor.

5.6.3 Using Arrays Instead of Iterating

Creating a Kepler workflow that repeats a task a number of times with different input data each time, does not always require iterations. Rather than creating a loop to repeat a calculation for a series of values, the values can all be passed and processed in a single

workflow iteration using data arrays. Both the *Expression* actor and the R actors, which are used for statistical computing, are designed to process data arrays, making workflows that use these actors good candidates for this type of solution.

For example, in Kepler expressions and R scripts, the '+' operator works not only with single numbers but also arrays (aka "vectors"). The workflow in *Figure 5.57* uses an *Expression* actor to read an array of values, add 10 to each value, and output the result.

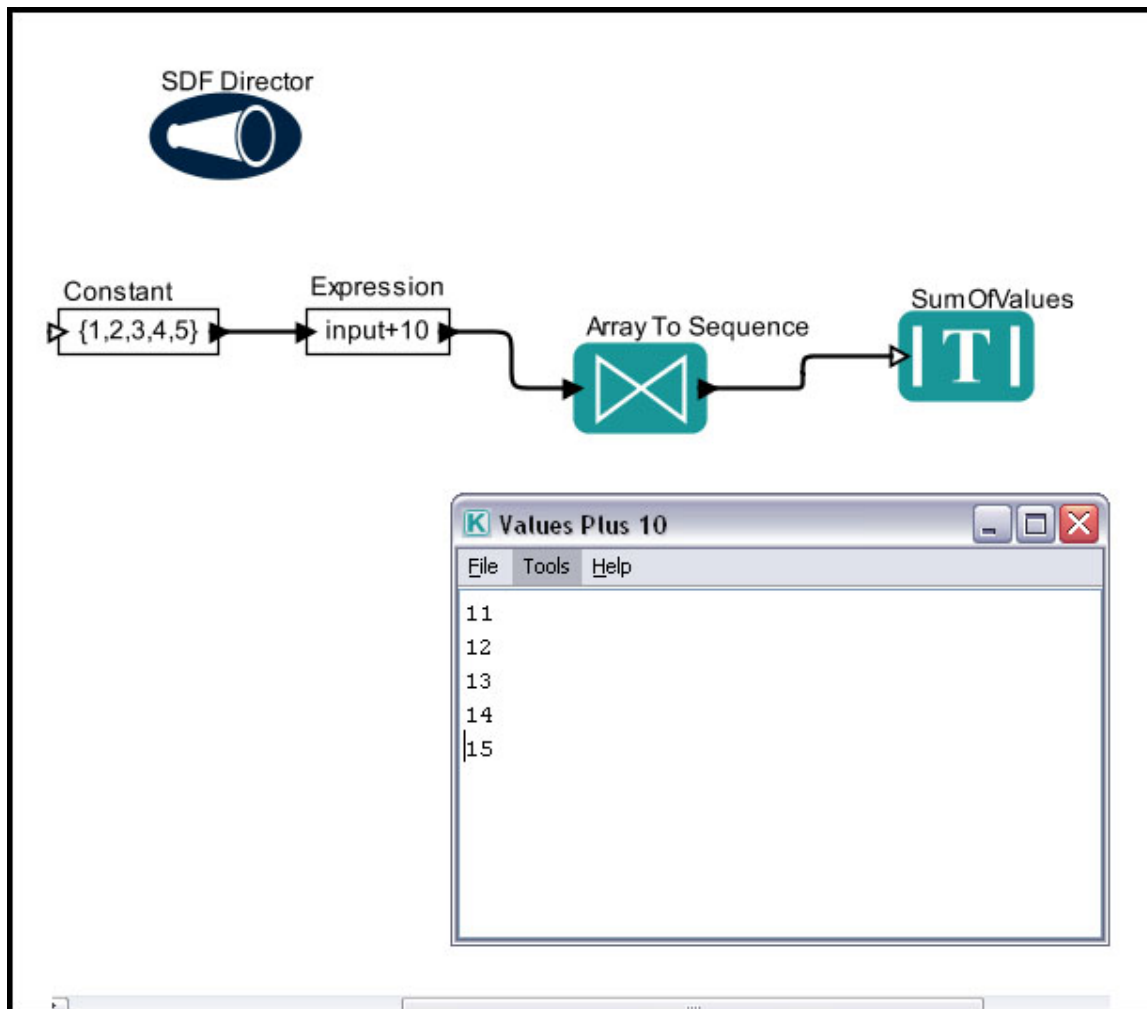

Figure 5.56: Passing an array of values to an *Expression* actor to process in a single workflow iteration.

The *Expression* actor in *Figure 5.57* receives an array through a user-defined port called *input*, which is referenced by the Kepler expression *input+10*. The results are output as an array, which is dismantled to a sequence of values and then displayed by the *Display* actor.

The *eml-simple-plot-R* workflow (*Figure 5.58*), included with the Kepler distribution (KeplerData/workflows/module/r-2.X.Y/demos/R/eml-simple-plot-R.xml) demonstrates how arrays can be used with an *RExpression* actor. The workflow uses two *SequenceToArray* actors to transform sequences of data (for relative humidity and

barometric pressure) that are stored on the EarthGrid in the dataset Datos Meteorologicos. These arrays are passed to an *RExpression* actor, which plots the data and outputs a graph of the information.

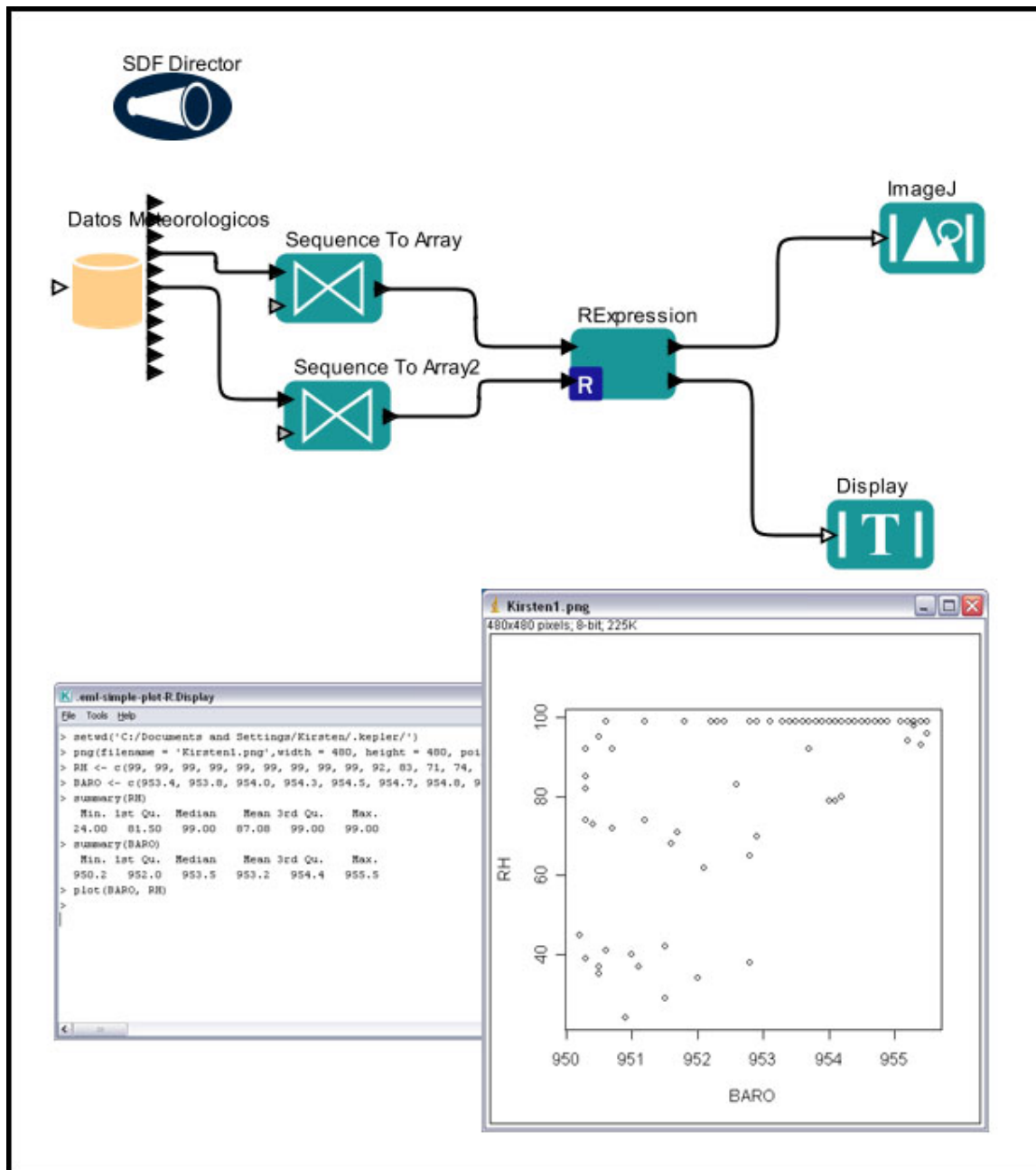

Figure 5.57: Passing data arrays to an *RExpression* actor instead of iterating the actor multiple times for individual values.

NOTE: To run this workflow R, a language and environment for statistical computing, must be installed on the computer running the Kepler application.

5.6.4 Iterating with Higher-Order Composites

Higher-order Composite actors, which are actors that operate on the structure of a model rather than on data,¹⁷ provide a convenient mechanism for iterating an entire sub-workflow. Of particular use is the higher-order composite actor called *RunCompositeActor*, which executes a contained workflow as if it were a top-level workflow each time it fires. The actor is well suited for use in workflows that repeatedly run other workflows with varying parameter values (*Figure 5.59*).

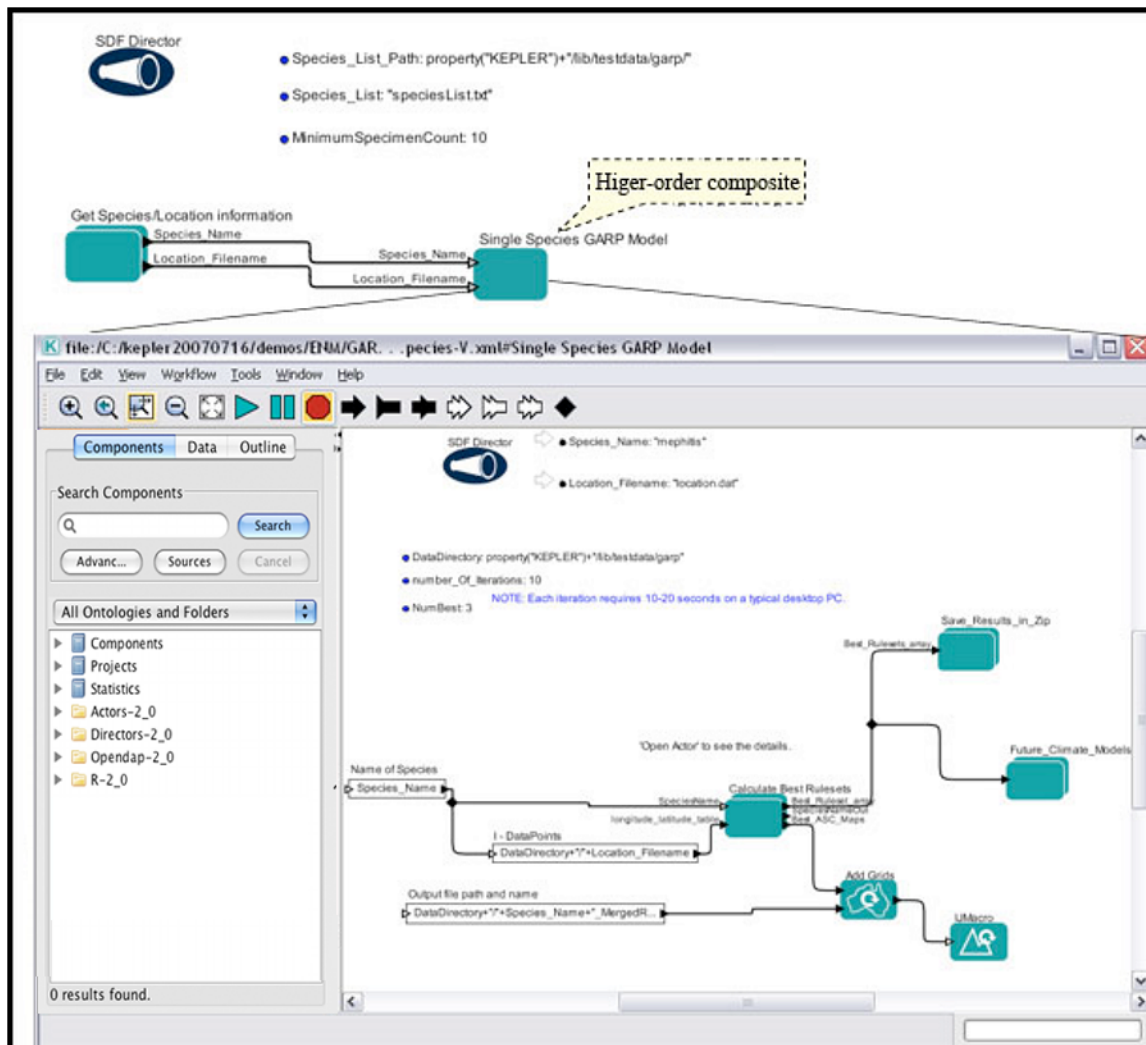

Figure 5.58: The GARP-MultipleSpecies-V.xml workflow uses a higher-order composite actor to iterate a complete workflow.

The higher-order composite actor in *Figure 5.59*, *Single Species GARP Model*, runs the contained workflow each time it fires. In this case, the contained workflow is used to create an environmental niche model for a single species; the top-level workflow iterates

¹⁷ Lee, Edward A. Steve Neuendorffer, Using Vergil
<http://ptolemy.berkeley.edu/ptolemyII/ptII6.0/ptII6.0.2/doc/design/usingVergil/usingVergila9.htm>

through a list of multiple species, and invokes the *RunCompositeActor* to calculate the niche model for each one.

The initial inputs of a workflow contained in a *RunCompositeActor* are specified as parameters or via port-parameters. The *RunCompositeActor* in the example uses two port-parameters: *Species_Name* and *Location_Filename*. The values of the parameters (mephitis and location.dat) are used for the first workflow iteration. Subsequent iterations use values passed to the *RunCompositeActor* by the top-level workflow via ports (i.e., additional species names and associated data to be processed).

5.6.5 Creating Feedback Loops

From integrating differential equations, to modeling signal amplification or how global warming and the concentration of greenhouse gases are related, feedback loops are a common workflow structure. A feedback loop consists of iterations that rely on the value of previous iterations. The simple example in *Figure 5.60* shows a workflow that adds one to the value of each previous workflow iteration and outputs the new sum, for example. A relation is used to branch the looped output so that the sums can be displayed as well as cycled back to the input of the *Add or Subtract* actor.

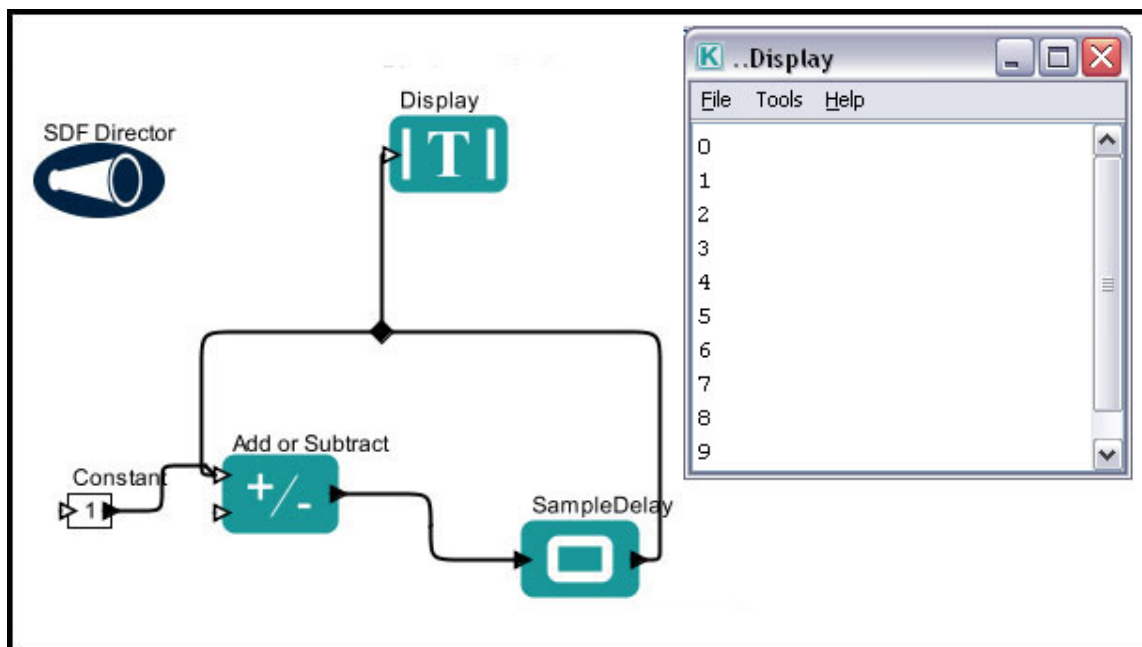

Figure 5.59: A simple feedback loop used to add one to the value of the previous iteration.

Note that the workflow in *Figure 5.60* uses a *SampleDelay* actor, which is required when constructing a feedback loop that uses an SDF director. The *SampleDelay* actor gets the iteration loop 'started'. Because the input of the feedback loop depends on its output, the loop will deadlock on the first iteration because there is not yet any output. The *SampleDelay* actor breaks this deadlock by providing some initial values (specified with

the *SampleDelay*'s `initialOutputs` parameter). On subsequent loop iterations, the actor simply passes along its inputs.

Feedback loops under different directors require different actors. Under a *PN Director*, for example a *Stop* actor is required to stop feedback loops, as the director has no iteration parameter (see `$Kepler/demos/SEEK/DiscreteLogistics_PN_Director.xml` for an example).

Probably the most straight-forward example of a feedback loop is the integration of a differential equation using the CT (Continuous Time) Director (*Figure 5.61*).

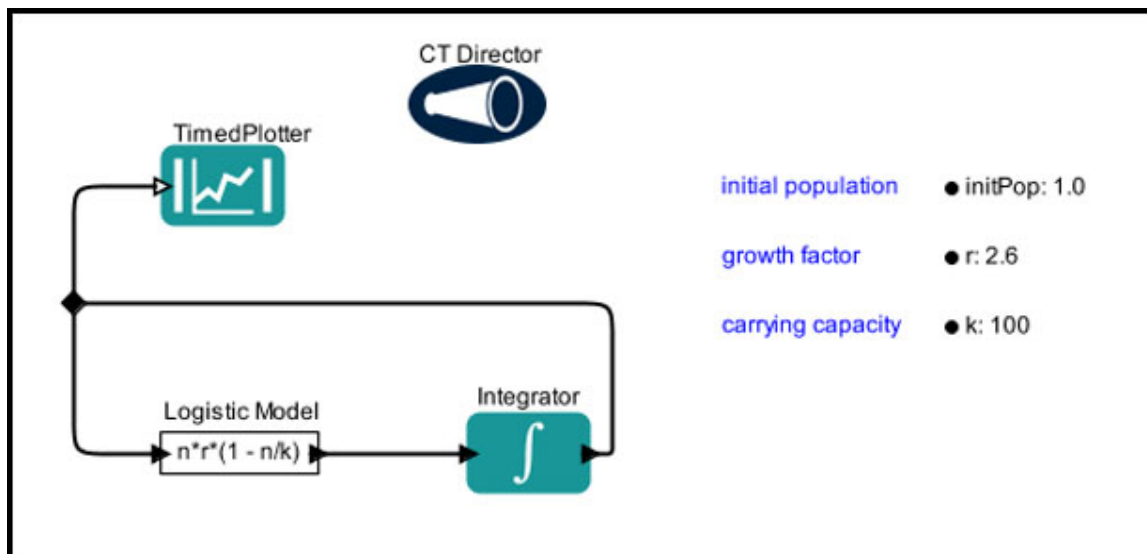

Figure 5.60: A workflow that uses a feedback loop to integrate a differential equation. This workflow can be found under `demos/SEEK/LogisticsModel_CT_Director.xml`.

The workflow in *Figure 5.61* solves the logistics equation, which is commonly used to describe resource-limited population growth. In this model, $n(t)$ is the population as a function of time and the rate of population change is given by $dn/dt = n*r*(1-n/k)$. The integrand (the right side of the equation) is put into an *Expression* actor, which is connected to an *Integrator* actor. The output of the *Integrator* is connected back to the input of the *Expression* actor, creating a feedback loop and providing the current value of n . In this example, the integrand is evaluated at some point in time and used to estimate the population at a slightly later time (the desired time interval is specified by the *CT Director* parameters). The estimated value is sent back to the *Expression* actor to evaluate again, and the loop continues to iterate using the output of the *Integrator* actor in each iteration. For examples of this workflow executed under an SDF and a PN director, see `demos/SEEK/DiscreteLogistics_SDF_Director.xml` and `demos/SEEK/DiscreteLogistics_PN_Director.xml`.

5.7 Documenting Workflows

Whether a workflow is to be shared with the public or used by only you, documentation is an important part of its development. Kepler has a number of documentation features that facilitate the process of annotating workflows. In general, we recommend that the workflow be annotated on the Workflow canvas and that in-depth documentation be added to the workflow documentation screen, which is accessed (both to read and to customize) via the workflow's right-click menu. Documentation should include the scientific problem that the workflow solves, how the problem is solved using the Kepler system, and the status of the workflow (if it is finalized, or what future work is planned). Documentation should also provide instructions for running the workflow, offering information about the type and format of data, the number of iterations to run, and any other information that is needed to understand and use the workflow.

5.7.1 Annotation Actors

The *Annotation* actor, which is included in the standard Kepler component library, provides an easy mechanism for adding notes to the Workflow canvas. Simply drag and drop the actor to the Workflow canvas and double-click the default annotation ("Double click to edit text") to open the parameters for customization. Any text added to the *Annotation* actor's `text` parameter will be rendered on the Workflow canvas. The other parameters allow basic formatting: size, color, and style (bold or italic).

A workflow can use any number of *Annotation* actors to document everything from an overview of the workflow to the function of an individual actor to the value of a parameter or format of a data set.

5.7.2 Documentation Menu

Right-click the Workflow canvas and select Documentation from the drop-down menu to begin using the workflow documentation screens. To add instructions to a workflow documentation screen, select Documentation > Customization from the menu. A dialog window with fields for a description, author, version, and date allow users to input instructional text. Click Commit to save the instructions and close the customization window. The entered content will appear the next time the documentation window is displayed.

Documentation content can include links to external web pages (which will open in a Kepler viewing window) and HTML formatting (``, `<tt>`, ``, etc). XML-reserved characters (e.g., `'>`, `'&`, `'"`, etc) must be escaped. The most common reserved characters and their entity replacement are listed in *Table 5.3*.

XML-reserved Character	Replace with:
&	&
<	<
>	>
"	"
'	'

Table 5.2: Common XML-reserved characters.

To delete the content of a documentation screen, select Documentation > Remove Customization. Note that this action cannot be undone with the "Undo" Menu bar item.

5.8 Debugging Workflows

Just because Kepler eliminates much of the need to code by providing a library of actors and a visual way to link them, does not mean that you will not encounter unexpected problems as you build, test, and execute your own workflows. However, Kepler provides a number of tools that can help you see how your workflow is executing and get to the bottom of errors quickly.

5.8.1 Animating Workflows

Select Animate at Runtime from the Tools menu to follow the execution of the workflow visually on the Workflow canvas. As each actor is executed, it will be highlighted with a red outline (*Figure 5.62*). The actor will remain highlighted for the number of milliseconds specified when the menu item is selected (e.g., 1000).

To turn off animation, simply select the "Animate at Runtime" menu item again. Note that the "Animate at Runtime" command only works correctly with workflows that use the *SDF Director*.

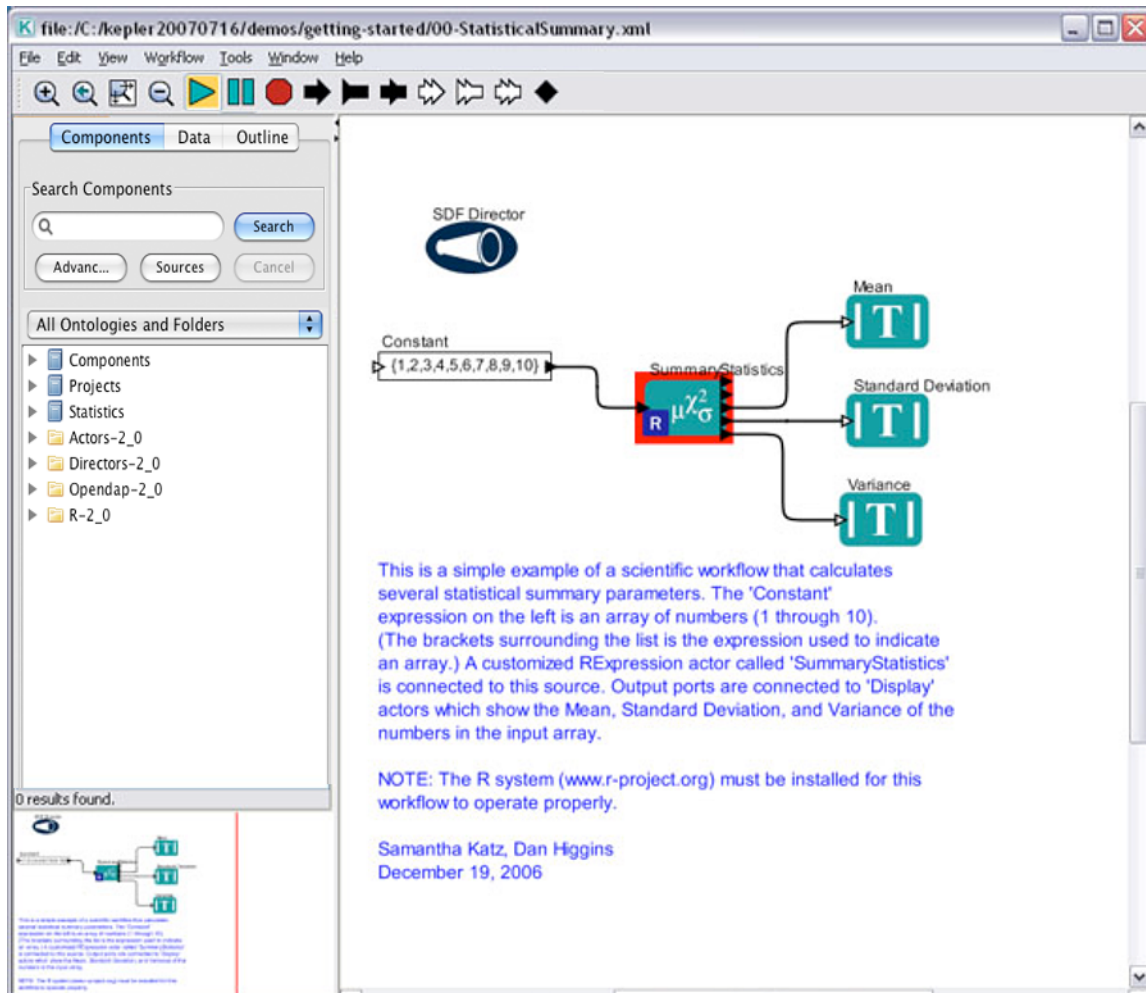

Figure 5.61: Select Animate Workflow to highlight the currently executing actor in red when the workflow is run.

5.8.2 Exceptions

When a workflow is run and something is amiss, Kepler often "throws an exception." An exception is an event that disrupts the normal flow of a program's instructions while the program is being executed.¹⁸ The exception appears as an error screen that contains information about the problem and an option to either Dismiss or Display Stack Trace (*Figure 5.63*).

¹⁸ Sun Microsystems, The Java Tutorials, <http://java.sun.com/docs/books/tutorial/essential/exceptions/definition.html>

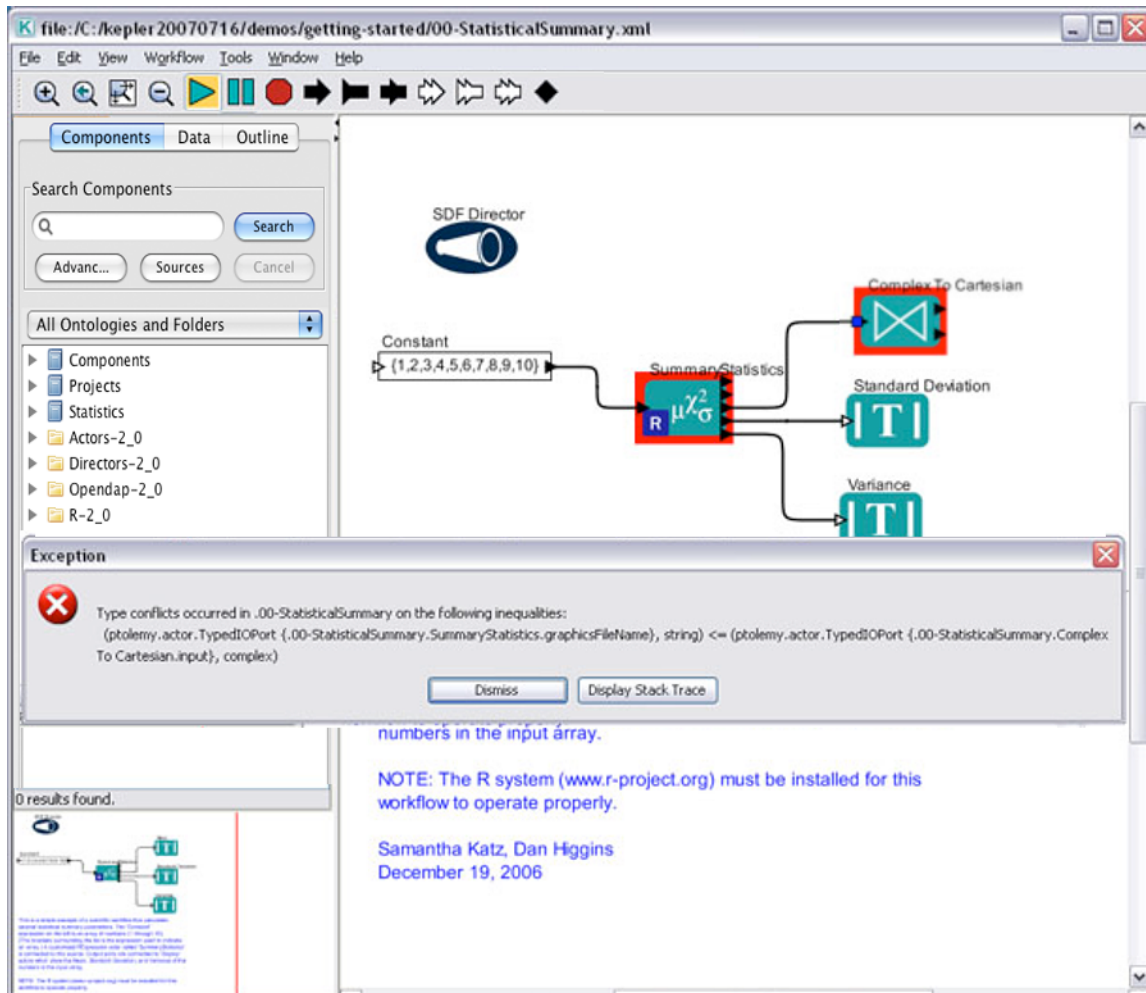

Figure 5.62: An exception message "thrown" when the workflow encounters trouble. Animate at Runtime is currently active, so the portion of the workflow experiencing the trouble is highlighted.

Click the Dismiss button to close the exception window and allow workflow execution to continue (if possible). The stack trace provides information about the workflow's execution history and lists the names of the Java classes and methods that led up to the error.

5.8.3 Checking System Settings

Select Check System Settings from the Tools menu to open a read-only display of the Kepler settings (*Figure 5.64*). System settings include, among other things, information about the current version of Java installed, the location of the Kepler installation, and the current operating system and home directory.

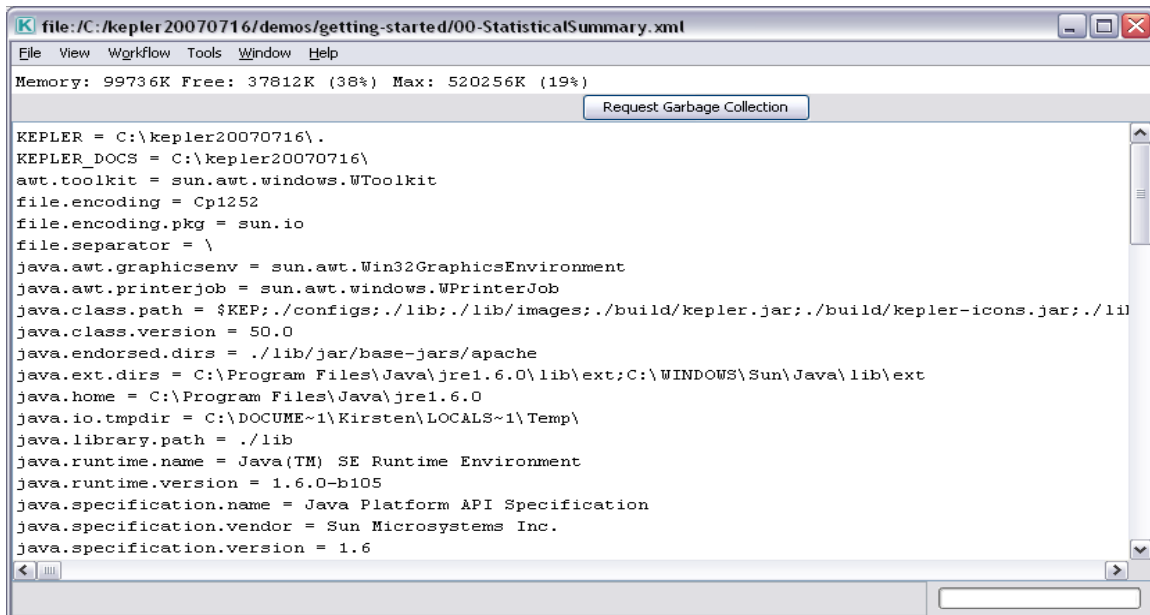

Figure 5.63: Kepler system settings.

5.8.4 Listening to the Director

Select Listen to Director from the Tools menu to open a viewing window that follows all of the director's activities as the workflow is run (*Figure 5.65*). Each time the director invokes a method or iterates an actor, the action is logged and displayed in the listening window.

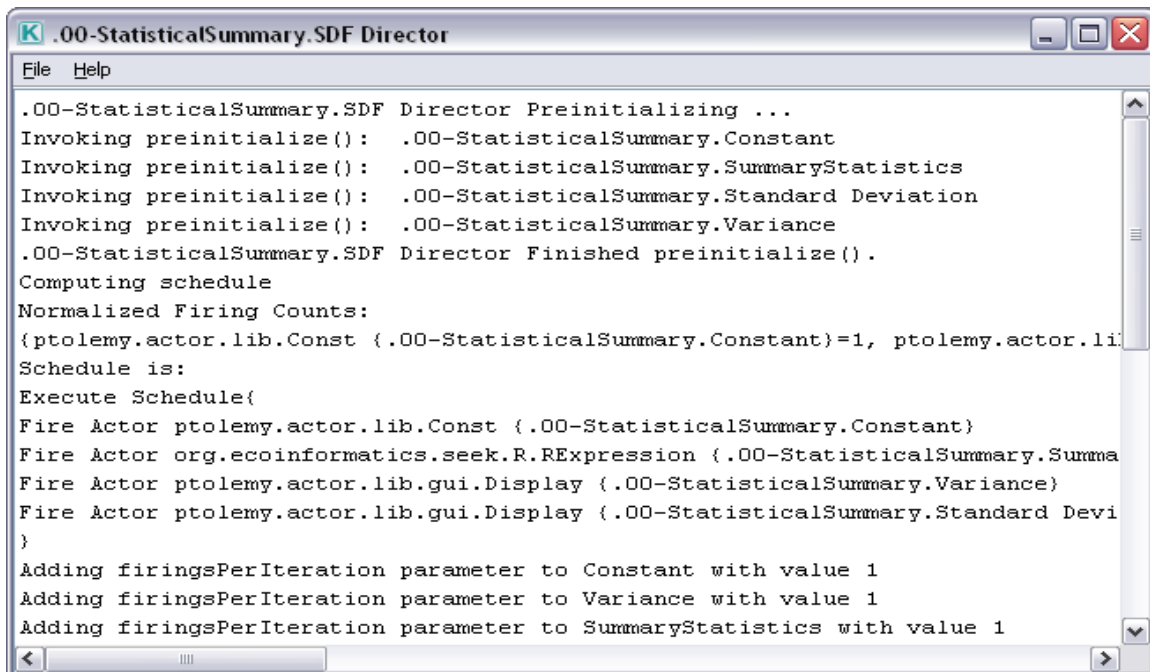

Figure 5.64: Listening to the director.

5.9 Saving and Sharing Workflows

Workflow files can be saved and shared in a number of ways: they can be saved as KAR or XML files and posted to a Web server, where XML workflows can be opened by users via the File > Open MoML URL menu option; they can be emailed or saved to a portable storage medium, and then opened with the File > Open File menu option; or, in instances where a workflow has been saved as a composite actor and all of the workflow components are contained in the local Kepler library, they can be instantiated via the Tools > Instantiate Component menu option.

5.9.1 Saving and Sharing Your Workflows as KAR or XML Files

Workflows can be saved and shared as KAR or XML files in a few easy steps:

1. Save the workflow by selecting Save, or Export (for XML) from the File menu. If the XML version of a workflow is posted to a website, users can open the workflow by selecting Open MoML URL from Kepler's File menu and typing in the URL of the remote workflow. Workflows sent via email can be opened via the File > Open and Open MoML menu items.

NOTE: An easy way to add additional instructions or contextual information (e.g., how to download and run the workflow) is simply to create a Web page with the instructions that includes a link to the workflow. Users will be able to open the Web page and navigate to the workflow via Kepler's Open MoML URL menu option.

2. If the workflow contains actors that are not included in Kepler's standard library (or that users may not have on their local machines), those actors must be shared as well. To share actors either:
 - a. Upload the actors to the Kepler Repository. The Kepler Repository allows users to both upload and download workflow components to a centralized server where they can be searched and re-used. For more information about uploading actors to the repository, see Section 5.34
 - b. Save the actors as KAR files, which can be emailed and imported. See Section 5.3.6 for more information.

Users interested in sharing the workflow must download the required actors from the repository (or import the emailed KAR files into Kepler) in order for the workflow to load properly. To search for and download actors from the repository, select the remote repositories you would like to search from the Tools > Preferences > Components tab, and then type in the name of the required component in the Search field. The component will automatically download when a user drags and drops the search result onto the Workflow canvas. If the result is a KAR, you may right-click on it and select Download, and it will be downloaded

into your local Save repository (MyWorkflows/ by default). For more information about opening a shared workflow, please see Section 5.9.2.

5.9.2 Opening and Running a Shared XML Workflow

If a shared workflow contains only standard Kepler components (ones distributed in the standard Kepler library), you can open and begin to use a shared workflow immediately. If, however, a workflow contains components specifically designed for that workflow—or that exist in the Kepler Repository, but are not included in the standard library—then those components will have to be added to the local Kepler library before the workflow can be run.

A well-documented workflow will contain information about the names and locations of any non-standard components required. In a perfect world, all workflows are well documented; however, there may be times when one must figure out what additional components are necessary, most likely by attempting to run the workflow, and then studying the error messages (*Figure 5.66*)

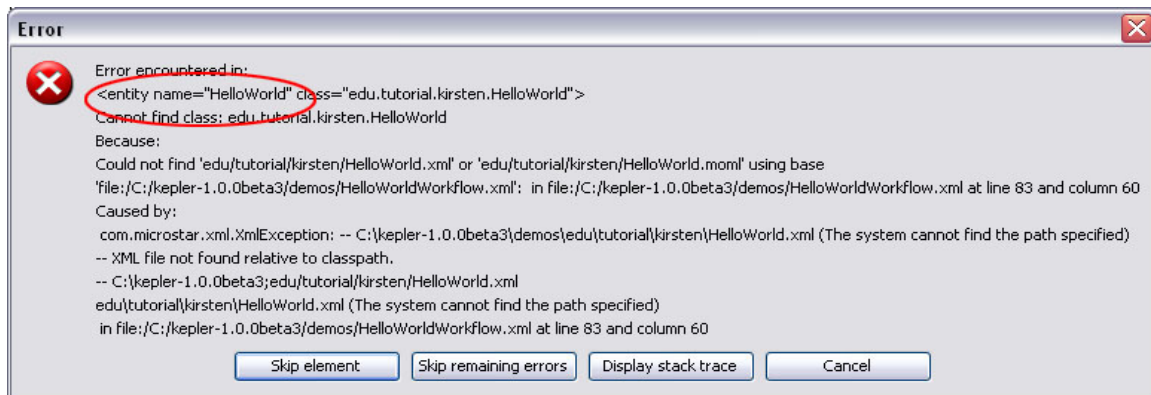

Figure 5.65: An error message that indicates that a workflow component is not available.

The error message in *Figure 5.66* indicates that Kepler cannot find the *HelloWorld* entity. The workflow that contains this actor will not run properly until the component is located and made available to the workflow. Although the *HelloWorld* workflow can be opened without the missing component, the workflow will not be drawn correctly and will not run properly (*Figure 5.67*).

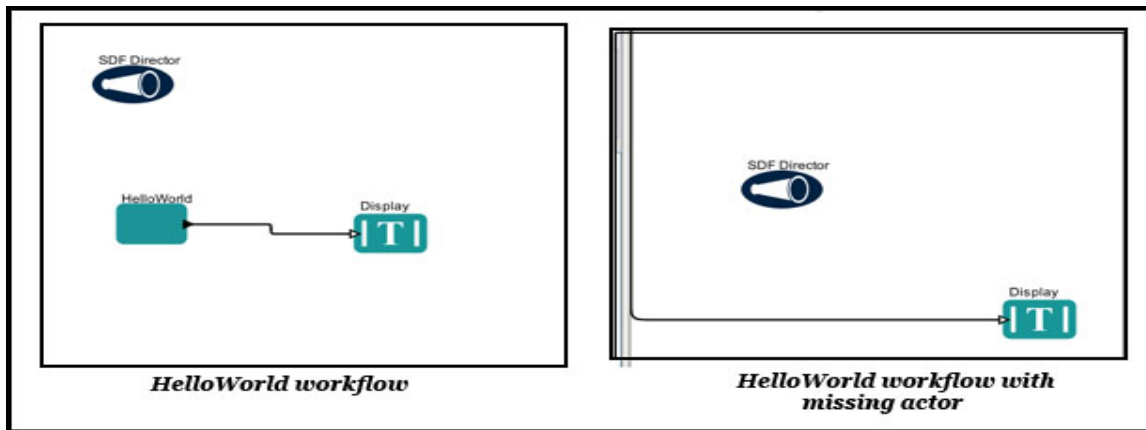

Figure 5.66: Workflows that contain missing actors will not open correctly on the Workflow canvas.

Missing components can be found in the Kepler Repository. Click the “Sources” button and click the checkbox in the “search” column next to “library.kepler-project.org.” If Kepler finds the actor in the repository, the actor will appear in the actor tree, where it can be dragged and dropped to the Workflow canvas (*Figure 5.68*).

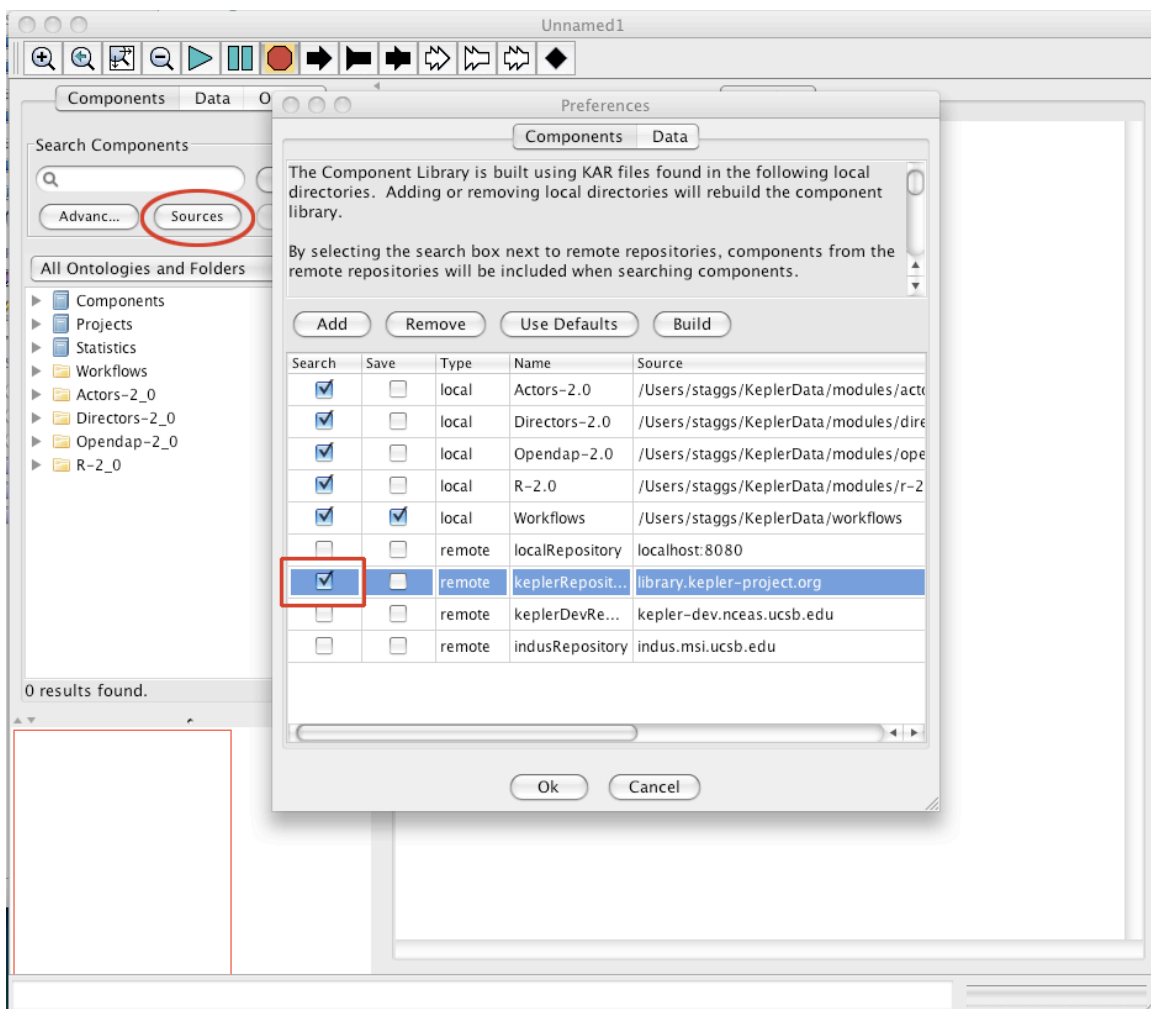

Figure 5.67: Locating missing components in the Kepler Repository.

6. Working with Data Sets

Kepler workflows can read, parse, and manipulate data that is stored in a variety of formats. From tabular data, such as local Excel tables saved as comma-delimited text files, to data contained in remote databases, to streaming sensor data, Kepler can incorporate a wide assortment of information using actors. For example, actors can read data files, open database connections and access stored information, and download and output data stored on the EarthGrid.

The EarthGrid, which is accessible from the Data tab, provides a convenient mechanism for discovering, accessing, and sharing data. The EarthGrid allows scientists access to ecological, biodiversity and environmental data and analytic resources (such as data, metadata, analytic workflows and processors) networked at different sites and at different organizations via the internet. Currently, the EarthGrid consists of the KNB Metacat and KU Digir data bases, which can be searched individually or in combination via the search form at the top of the Data tab.

Metadata, such as EML (Ecological Metadata Language) or ADN (ADEPT/DLESE/NASA), describes data so that they can be easily understood by both scientists and actors. Actors use the metadata to automatically configure themselves with appropriate data output ports. Although not every data set contains metadata, the benefits of working with metadata-described data sets quickly makes the utility apparent. See Sections 6.2 and 6.3 for examples of a biomass workflow constructed with EML data and without EML.

How data are incorporated into a workflow depends to a large extent on how the data are structured and stored. Are the data locally available? Are the data described by metadata? Stored in a database? Formatted as a table? In each scenario, different actors can be combined to access the data and prepare it for use.

6.1 Data Actors

The standard Kepler component library contains a number of actors used to read, write, and translate data for use in workflows. Whether data sets are stored on a local machine, the EarthGrid, or another remote server, actors can be used to access and output the information. Actors used to read and write data are easily recognized by the peach-colored file or drum icon that represents them on the Workflow canvas. Other useful data actors are noted in the table below (*Table 6.1*).







Data/File Access	Data/File Access actors do not have a persistent family symbol. Actors belonging to this family read, write, and query data.	
	Data Access Support	Data Access Support actors are generally used to open and close database connections, or to send commands to a data source. Actors: Close Database Connection, Open Database Connection, SRB Connect, SRB Create Query Conditions, SRB Create Query Interface, SRB Get Physical Location, SRB Proxy Commands, PhyloDataReader
	Data Query	Data Query actors query data sources or metadata. Actors: Database Query, SRB Query Metadata, Transitive Closure Database Query
	Reads/Gets/Sources	Reads/Gets/Sources actors read data into a Kepler workflow: files, images, or data sets. Actors: Binary File Reader, Expression Reader, File Reader, File To Array Converter, Image Reader, Line Reader, Simple File Reader, NexusFileReader, EML2Data set, Orb Image Source, Orb Packet Object Source, SRB Get Metadata, SRB SGet, SRB Stream Get, DataTurbine
	Read/Write	Read/Write actors read and write data from host servers. Actors: FTP Client, Ecogrid Writer
	Write/Put/Sink	Write/Put/Sink actors write data to output files or sinks, which store data for future use. Actos: Binary File Writer, File Writer, Line Writer, Text File Writer, Orb Waveform Sink, Orb Waveform Source
	Data Processing	Data Processing actors process data—converting data from one format to another or extracting specified values from a data set. Actors: ClimateChangeFileProcessor, ClimateFileProcessor, SProxy, Experiment Monitor, Xpath Processor, XSLT Processor, Interpolator, Lookup Table, Record Assembler, Record Disassembler, RecordUpdater, Vector Assembler, Vector Disassembler, Polygon Diagrams Dataset, Polygon Diagrams Transition, PAUPIinfer, RecIDCM3, TreeDecomposer, TreeImprover, TreeMerger, TreeParser

Table 6.1: Useful data actors

6.2 Using Tabular Data Sets with Metadata

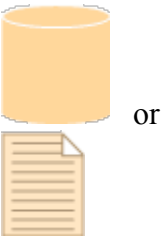
Although one might guess that the easiest way to incorporate data into a workflow is via a simple tab-delimited text file, the most convenient way to access data is actually with data sets described by metadata, or data that describes the data set.

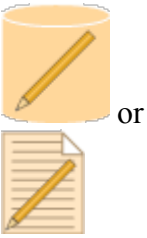
Ecological Metadata Language (EML) is a broad metadata specification that was originally developed by the ecology community, but can be easily used by other domains. It is based on prior work done by the Ecological Society of America and associated efforts (Michener et al., 1997, Ecological Applications). EML is implemented as a series of XML document types that can be used in a modular and extensible manner to document data. Each EML module is designed to describe one logical part of the total metadata that should be included with any data set.¹⁹

Other types of metadata commonly used on the EarthGrid are Darwin Core and ADN (ADEPT/DLESE/NASA). The purpose of the ADN metadata framework is to describe resources typically used in learning environments (e.g. classroom activities, lesson plans, modules, visualizations, some data sets) for discovery by the Earth system education community.²⁰ The Darwin Core (sometimes abbreviated as DwC) is a standard designed to facilitate the exchange of information about the existence of specimens in collections and the geographic location where they were collected. Extensions to the Darwin Core provide a mechanism to share additional information, which may be discipline-specific, or beyond the commonly agreed upon scope of the Darwin Core itself.²¹

Kepler has several actors designed to automatically download and output EML and Darwin Core described data: the *EML 2 Dataset* actor and *DarwinCoreDataSource* actor, which automatically download a data set and configure output ports to emit each field of data.

Kepler's *EML 2 Dataset* actor understands EML: the actor parses the meta information when a data set is downloaded (or accessed locally), and emits data to downstream actors. A sample set of EML-described data ("Vegetation Test Data") for use with this manual is on the KNB Metacat node of the EarthGrid. To access that data (or any data on the EarthGrid), select the Data tab. In this case, we know the data are on the KNB Metacat server, and we can narrow our search (and reduce the search time) by searching only that data source (under Sources, deselect the KNB Authenticated Query and KU Digir source (*Figure 6.1*)).

The "Refresh" button on the Sources window allows Kepler to immediately synchronize the application's list of configured sources with all Earthgrid-registered sources. If

¹⁹ KNB Website, <http://knb.ecoinformatics.org/software/eml/>

²⁰ DLESE website, <http://www.dlese.org/Metadata/adn-item/>

²¹ TDWG Wiki, <http://wiki.tdwg.org/DarwinCore>

Kepler's existing sources configuration should be preserved, the optional checkbox allows the new and old to be merged upon refresh.

The KNB supports public searches as well as searches for access-restricted data packages. If the Authenticated Query source is selected, a prompt for username, password and organizational affiliation will be presented. Upon successful login, the search will be performed, and both public and appropriately configured access-restricted data packages will be returned. There is no need to search *both* the public and authenticated sources simultaneously.

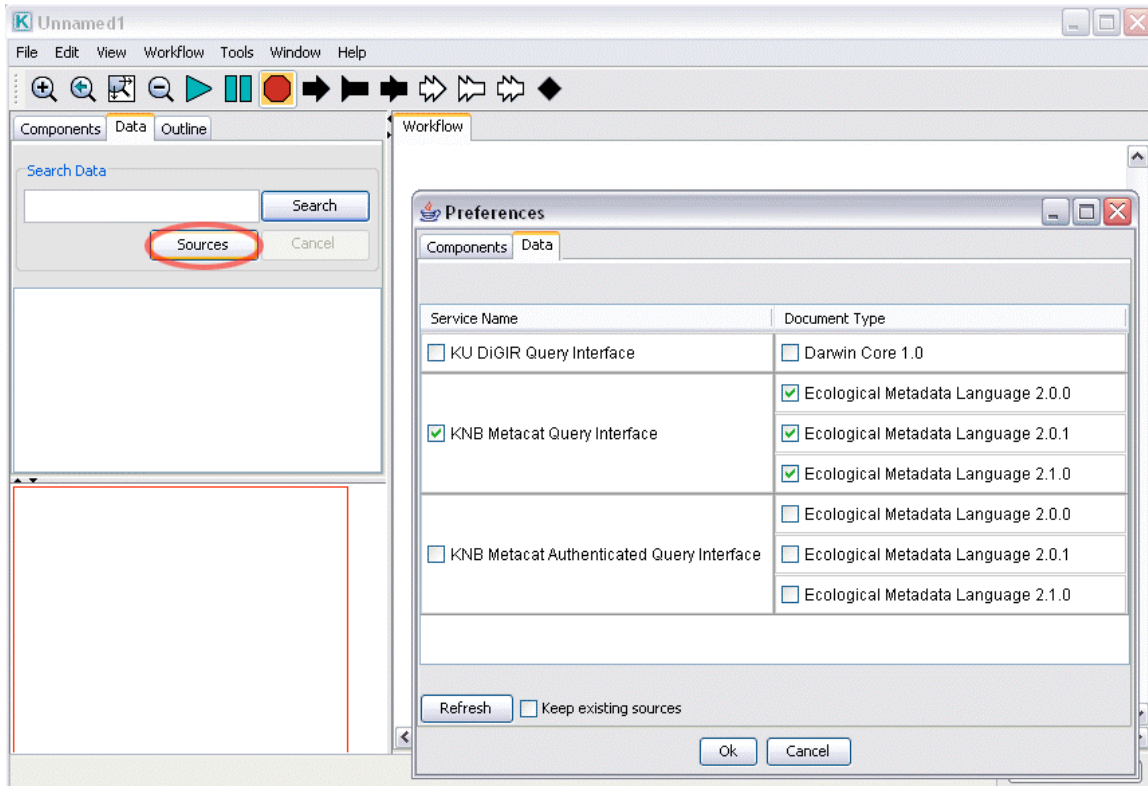

Figure 6.1: Customizing the sources to be searched. In the above example, only the KNB Metacat source will be searched as KU Digir and the Authenticated Query have been deselected.

To find a data set, type its name or a portion of its name into the Search field and click Search. The search may take several seconds. When complete, the search will return a number of data sets that match the search query. Note the peach data drum icon beside each data set; this icon indicates that the data can be accessed with the *EML 2 Dataset* actor. In fact, dragging and dropping any of the data sets onto the Workflow canvas instantiates an *EML 2 Dataset* actor that accesses the data (*Figure 6. 2*).

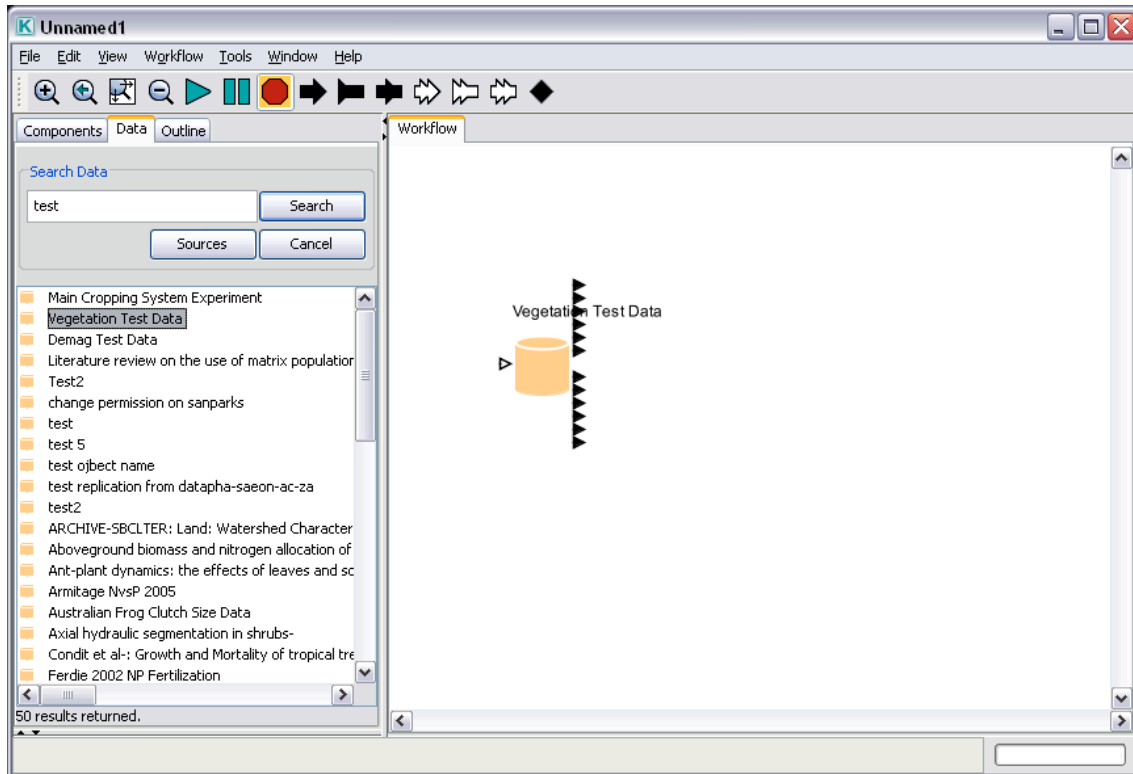

Figure 6.2: Dragging and dropping an EML-described data set onto the Workflow canvas instantiates an *EML 2 Dataset* actor.

To open a local data set that is described by EML, simply drag and drop an *EML 2 Dataset* actor on to the Workflow canvas and configure the actor parameters to point to the file name of the data source and its corresponding metadata file (*Figure 6.3*). The *EML 2 Dataset* actor will automatically configure its output ports to correspond to the fields described by the metadata.

The actor's parameters (*Table 6.2*) can be customized to access and output data in a variety of ways:

EML File	The file path of a local EML metadata file used to describe and access an EML data set.
Data File	The path to a local data file described by EML (must be used in conjunction with a local EML file). The actor will retrieve the data and automatically configure its ports to output it.
Selected Entity	If this EML data package has multiple entities, the selectedEntity parameter specifies which entity should be output. When this parameter is unset (the default), data from the first entity described in an EML package is output. This parameter is only used if no query statement is specified, or if a query statement is used and the output format is one of "As Table", "As Byte Array", "As Uncompressed File Name", and "As Cache File Name". To specify a query statement, right-click the actor and select Open Actor.

Data Output Format	The format in which the actor should output the data. See section 6.2.2 for more information about the different data output formats and how they are used.
File Extension Filter	A file extension that is used to limit the array of filenames returned by the data source actor when "As UnCompressed File Name" is selected as the data output format. Only files that match the specified extension will be returned. Specify a file extension without a leading period.
Allow lenient data parsing	If this parameter is selected, "extra" columns of data (e.g., comments that people have entered on a line or something of that nature) that are not described in the metadata are ignored, allowing the workflow to execute. If the option is unchecked (the default), the workflow execution will halt until the discrepancy between the data and metadata is corrected.
Check for latest version	Select this parameter to check the EarthGrid for updates to the data. If the actor finds a version of the data that is more recent than the cached data on your local system, the actor will prompt the user to either download the latest data and metadata or ignore the newer version. Note that different versions of the data can have vastly different structures (new columns, or even new tables of data might be included or removed). If this parameter is selected, users should be prepared to handle changes that might arise from differences in the data structure.
recordid	(appears for downloaded data actors only) An identifier used to retrieve the metadata from the EarthGrid. Typically, this identifier is set automatically when a data package is dragged to the Workflow canvas.
endpoint	(appears for downloaded data actors only) The endpoint is used to retrieve data and metadata from the EarthGrid. Typically, this parameter is left at its default value.
namespace	(appears for downloaded data actors only) The namespace sets the type (and version) of the EML document used by the actor.

Table 6.2: Parameters of the EML 2 Dataset actor.

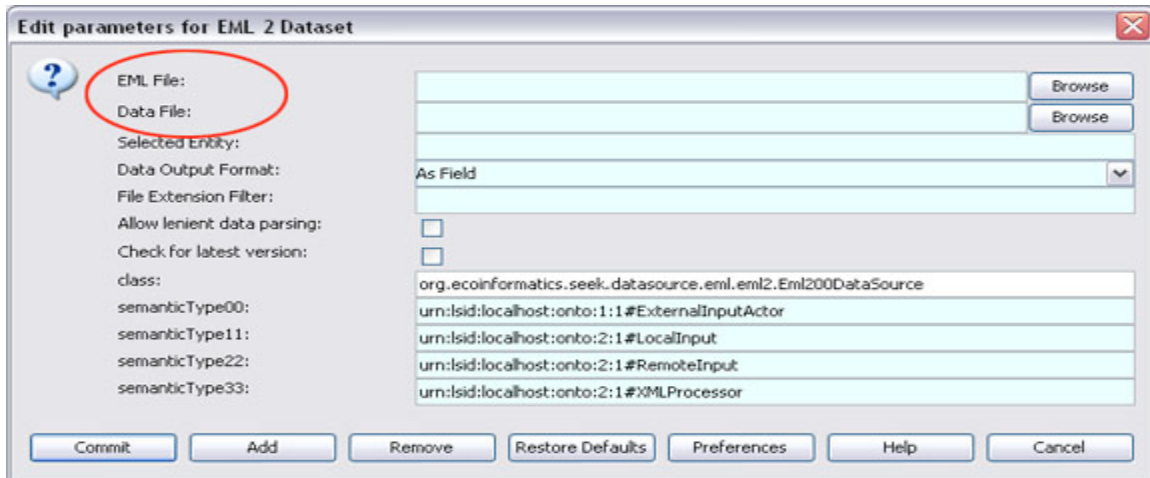

Figure 6.3: Configuring an *EML 2 Dataset* actor to read a local data set described with Ecological Metadata Language

After parsing a data set's EML metadata, the *EML 2 Dataset* actor automatically reconfigures its exposed ports to provide one port for each column of data described by the EML description. For example, the Vegetation Test Data metadata has twelve attributes describing twelve columns of data: Date, Site, Web, Plot, QD, Species, Obs, Cover, Height, Count, Phen, Comments. The *EML 2 Dataset* actor will therefore create 12 corresponding output ports. To view the metadata, right-click the *EML 2 Dataset* actor and select Get Metadata from the drop-down menu. Scroll to the bottom of the description to see the data attributes and more information about each (*Figure 6.4*).

Attribute Name	Column Label	Definition	Type of Value	Measurement Type	Measurement Domain	Missing Value Code	Accuracy Report	Accuracy Assessment	Coverage
DATE	DATE	Date of sample	datetime	datetime	Format MM/DD/YYYY Precision 1 day				
SITE	SITE	Site of observation, from site/web/plot/quad hierarchy	nominal	Enumerated Domain	Order				
				Code	Code	FPC			
				Definition	Definition	Five-Points creosote			
				Source	Order				
				Code	Code	CM			
				Definition	Definition	Cerro Montosa			
				Source	Order				
				Code	Code	J			
				Definition	Definition	Savanna			
				Source	Order				
				Code	Code	FPG			
				Definition	Definition	Five-Points grassland			

Figure 6.4: A portion of the EML metadata for the Vegetation Test Data. The *EML 2 Dataset* actor creates one output port for each defined attribute (DATE, SITE, etc).

The data are formatted as a comma-separated table containing observations of the height and cover (among other things) of the species "ERPU8." To preview the data, right-click the actor and select Preview from the drop-down menu (*Figure 6.5*). The preview table can be resized, or sorted by clicking the column headers. Sorting time increases for very large data sets.

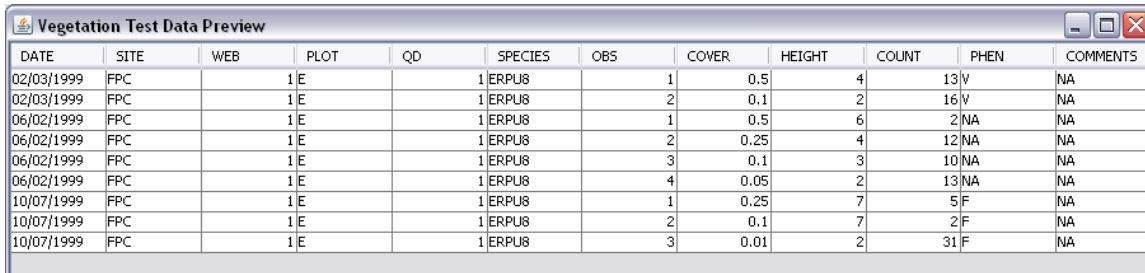

DATE	SITE	WEB	PLOT	QD	SPECIES	OBS	COVER	HEIGHT	COUNT	PHEN	COMMENTS
02/03/1999	FPC		1E		1 ERPU8	1	0.5		4	13 V	NA
02/03/1999	FPC		1E		1 ERPU8	2	0.1		2	16 V	NA
06/02/1999	FPC		1E		1 ERPU8	1	0.5		6	2 NA	NA
06/02/1999	FPC		1E		1 ERPU8	2	0.25		4	12 NA	NA
06/02/1999	FPC		1E		1 ERPU8	3	0.1		3	10 NA	NA
06/02/1999	FPC		1E		1 ERPU8	4	0.05		2	13 NA	NA
10/07/1999	FPC		1E		1 ERPU8	1	0.25		7	5 F	NA
10/07/1999	FPC		1E		1 ERPU8	2	0.1		7	2 F	NA
10/07/1999	FPC		1E		1 ERPU8	3	0.01		2	31 F	NA

Figure 6.5: A preview of the Vegetation Test Data data set.

When it is dragged to the Workflow canvas, the *EML 2 Dataset* actor automatically downloads the data to the Kepler cache. If the data have already been downloaded, the actor will access them from the cache.

Each time the *EML 2 Dataset* actor fires, it outputs one row of data via its ports. Rollover an output port to see the name and type of the data output (*Figure 6.6*), or right-click the *EML 2 Dataset* actor and select Configure Ports to customize the actor so that the port names (which correspond to the name of each data item) appear on the Workflow canvas.

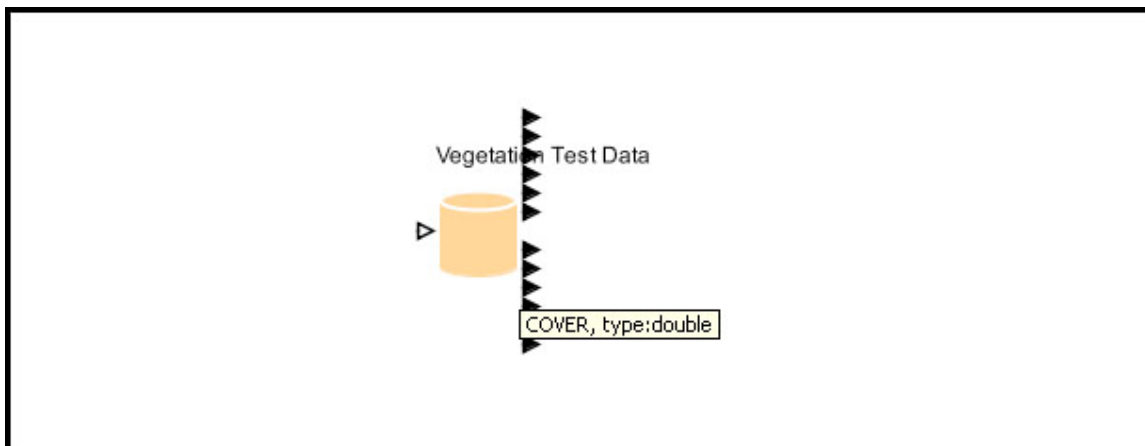

Figure 6.6: Roll over any port of the *EML 2 Dataset* actor with the cursor to open a tooltip containing the name of the port and the type of the data it broadcasts.

To use the Vegetation Test Data to investigate relationships between plant volume and biomass for the species "Erpu8," simply locate the *cover* and *height* ports and connect them to the input ports of a graphing actor (biomass is a function of the species' cover percent and height over time) (*Figure 6.7*).

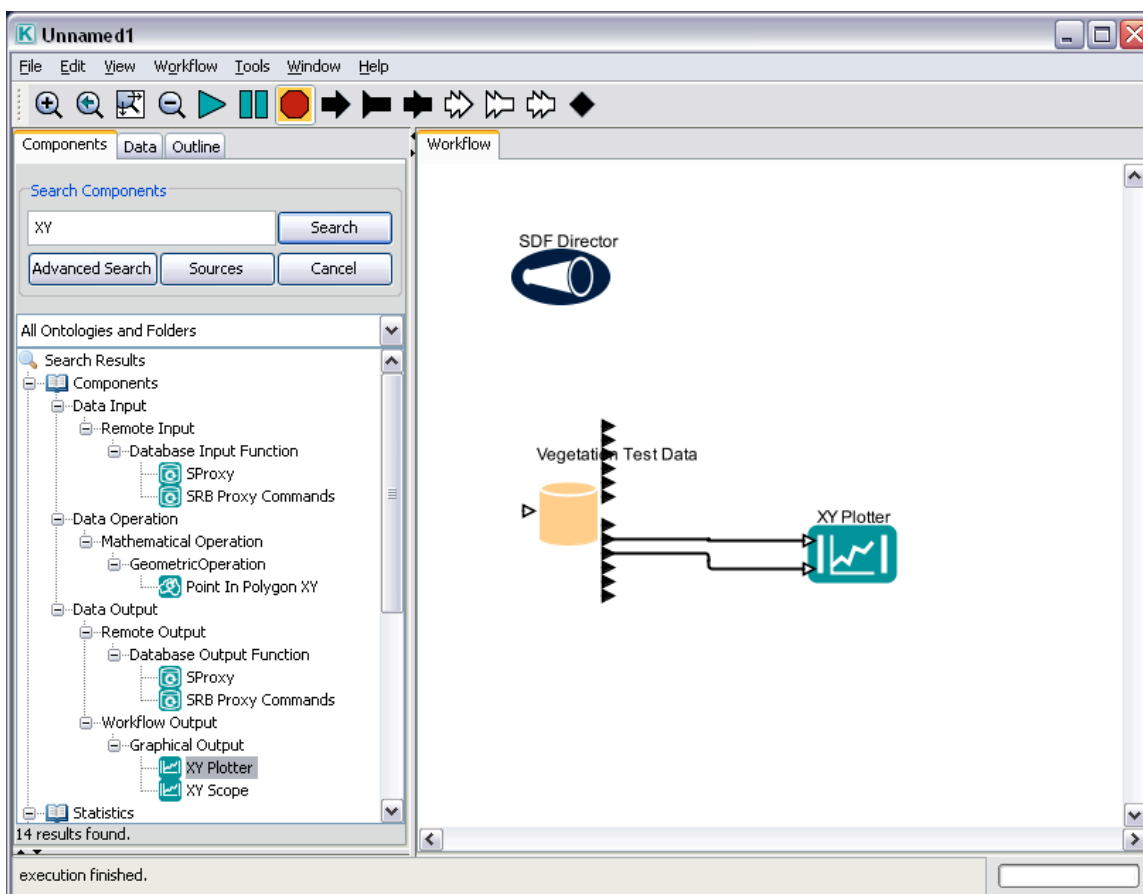

Figure 6.7: An example workflow that uses an *XY Plotter* actor to plot the "cover" and "height" of the example species, Erpu8.

NOTE: Until the graphical output of the workflow in *Figure 6.7* is customized, it produces a somewhat unintelligible plot. Click the configure plot setting in the upper right corner of the output graph (*Figure 6.8*).

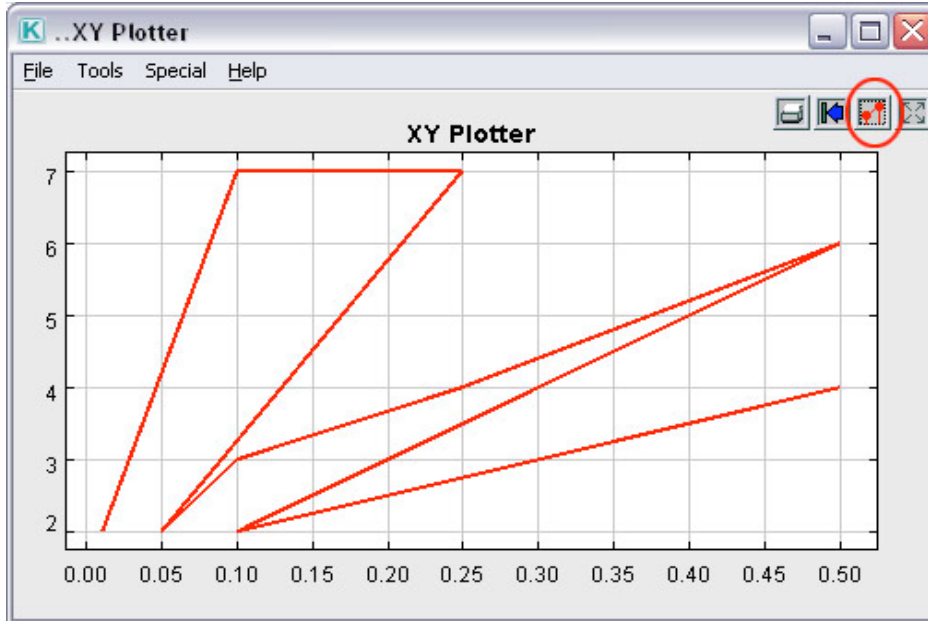

Figure 6.8: The output of the workflow displayed in *Figure 6.7*. Click the configure graph button in the upper right corner to customize the graph.

In the "Set plot format" dialog window, specify a title and an axis label. Deselect "Connect" and select "dots" as the type of mark (*Figure 6.9*). Changes will be applied to the current graph and to graphs produced in subsequent workflow runs.

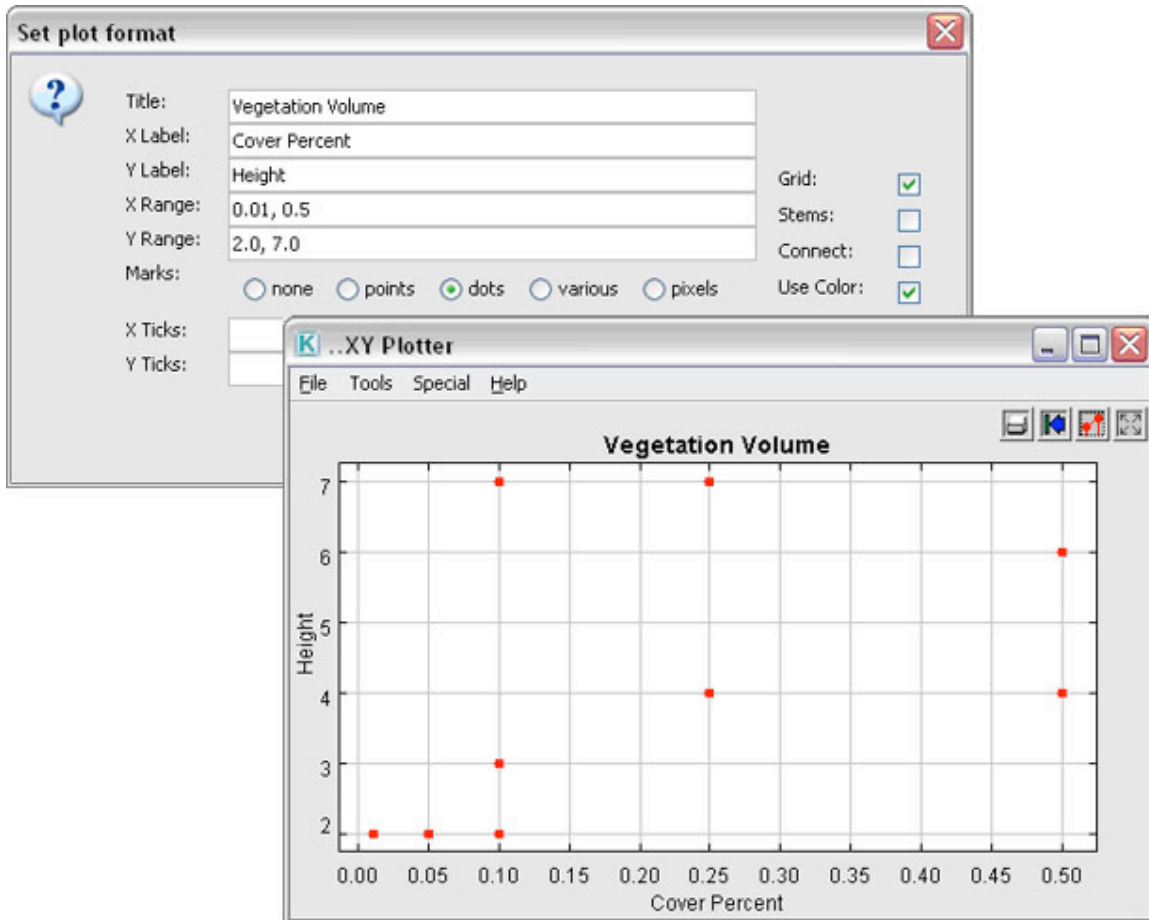

Figure 6.9: Customizing the output of the *XY Plotter* actor.

6.2.1 Viewing Metadata

A data set's metadata can be viewed either from the Data tab or the Workflow canvas. To view the metadata from the Data tab, right click the name of the data set, and then click the Get Metadata option. The metadata will open in a viewing window. To view metadata from the Workflow canvas, right-click the data actor icon and select Get Metadata from the drop-down menu.

Metadata includes the name of the data set, the name of the data set owner, the structure of the data (e.g., tab-delimited), the number of records in the data set, and information about each field of data (name, type, date, etc).

6.2.2 Outputting Data for Use in a Workflow

The *EML 2 Dataset* actor automatically configures itself with one output port for each field of data described by the metadata. A data set that has four fields (date, time, location, and species name) will, by default, "generate" an *EML 2 Dataset* actor that has four output ports, each assigned the data type defined in the metadata (the "location" port will have type "string", for example). The *EML 2 Dataset* actor can also be used to unzip compressed data sets, and to output a data set in a number of useful formats. Instead of outputting each field of data individually, the actor can be configured to create one port that emits the entire data table at once in comma-delimited format, for example. Specifically, the output format choices are: as table, row, byte array, uncompressed file name, cache file name, column vector, or column-based record.

To customize the output format of the data set, double-click the *EML 2 Dataset* actor and select a format from the drop-down menu beside the Data Output Format setting.

As Field: (the default) The *EML 2 Dataset* actor creates one output port for each field (aka column/attribute/variable) that is described in the EML metadata for the data set (*Figure 6.10*). If the Query Builder has been used to subset the data, then only those fields selected in the SQL statement will be configured as ports (See Section 6.2.3 for more information about the Query Builder).

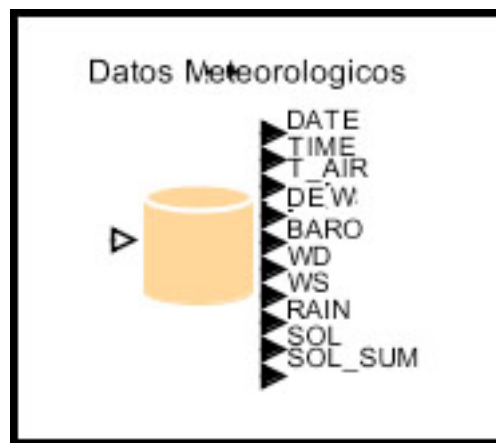

Figure 6.10: An *EML 2 Dataset* actor customized to output the *Datos Meteorologicos* data set as fields (the default).

As Table: The data set will be output as a string that contains the entire data set (*Figure 6.11*). The *EML 2 Dataset* actor will configure itself with three output ports: `DataTable` - the data itself, `Delimiter` - the delimiter used to separate fields (e.g., a comma or tab), and `NumColumns` - the number of fields in the table.

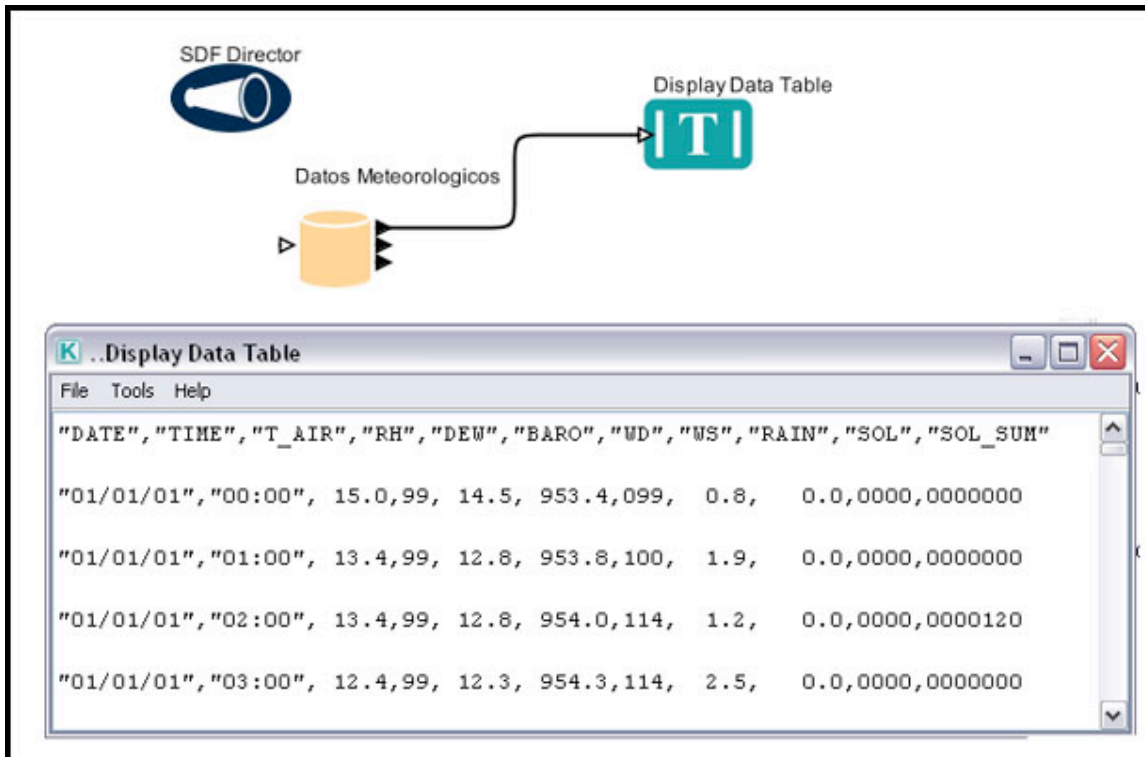

Figure 6.11: Using an *EML 2 Dataset* actor to format and output a data set as a table via a single output port. In this case, the delimiter is a comma ",".

As Row: The *EML 2 Dataset* actor formats one row of the data set as an array and outputs it. The actor creates only one output port (`DataRow`) and the data type is a record containing each of the individual fields. (e.g., {BARO = 953.4, DATE = "01/01/01", DEW = 14.5, RAIN = 0.0, RH = 99, SOL = 0.0, SOL_SUM = 0.0, TIME = "00:00", T_AIR = 15.0, WD = 99, WS = 0.8}.

As Byte Array: The *EML 2 Dataset* actor outputs the data set as an array of bytes (raw data sent in binary format). The actor configures itself with two output ports: `BinaryData` -- contains data itself, and `EndOfStream` -- a tag to indicate the end of the data stream.

As UnCompressed File Name: If the data set is a compressed file (zip, tar, etc), the "As UnCompressed File Name" format instructs the *EML 2 Dataset* actor to uncompress the data after it is downloaded. The actor will configure itself with one output port that outputs an array of the filenames of the uncompressed archive files.

As Cache File Name: Kepler stores remotely downloaded data files into its cache system. This format outputs the local cache file path of the data set so that workflow designers can directly access the cache files. The actor configures itself with two output ports: `CacheLocalFileName` - the local cache file path, and `CacheResourceName` – the data set's EML identity (e.g., `ecogrid://knb/tao.2.1`).

As Column Vector: This output format is similar to "As Field". The difference is that instead of sending out a single value on each port, the *EML 2 Dataset* actor outputs an array of all of the data for each field.

As Column Vector: This output format is similar to "As Field". The difference is that instead of sending out a single value on each port, the *EML 2 Dataset* actor outputs an array of all of the data for each field. This format is particularly useful when the output is directed to an *RExpression* actor, which creates a vector object that is immediately available for use in R the script.

As ColumnBased Record: The *EML 2 Dataset* actor outputs the data set on one port using a Record structure that encapsulates the entire data object. The Record will contain one array for each column of data, and the type of that array will be determined by the type of the field it represents. This format is particularly useful when the output is directed to an *RExpression* actor, which creates a dataframe object that is immediately available for use in R the script.

6.2.3 Querying Metadata

At times, you may wish to use only a portion of the data in a given data set—only records from May 2006, for example, or only records that relate to one of four species tracked in a data set for a specific location. The *EML 2 Dataset* actor has a built-in query builder that allows users to quickly and easily identify and output only the desired fields of information.

To access the Query Builder, right-click the *EML 2 Dataset* actor and select Open Actor from the drop-down menu (*Figure 6.12*)

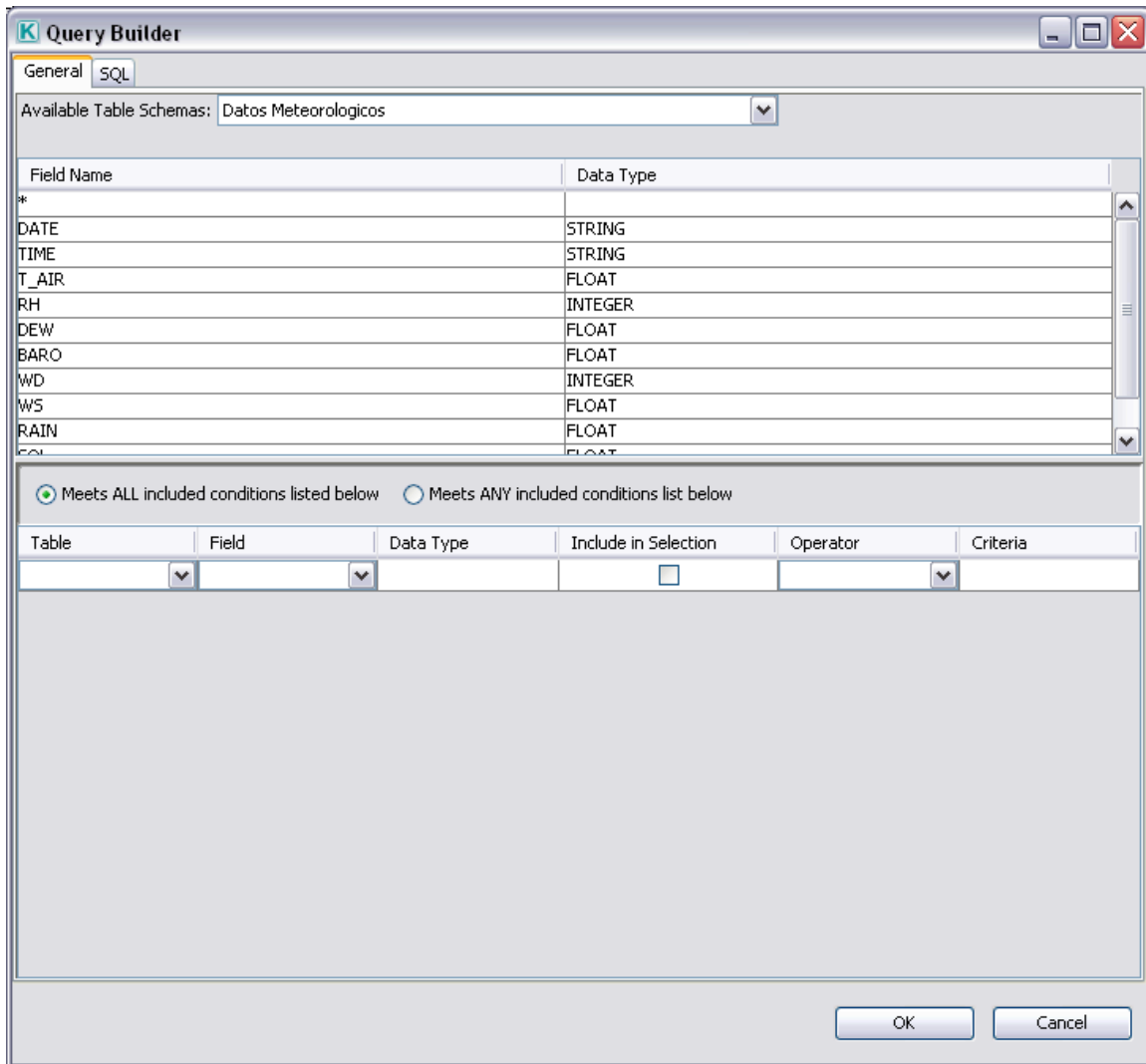

Figure 6.12: The Query Builder for the Datos Meteorologicos data set.

At the top of the Query Builder is a drop-down menu containing the name of each data table in the data set (the Datos Meteorologicos data set contains only one table, named Datos Meteorologicos). Beneath the table name is a list of the fields (as defined in the metadata) in the selected table as well as the data type of each field.

Use the settings at the bottom of the Query Builder to select only the desired tables and fields from the data set. For example, to select only the rainfall data from the Datos Meteorologicos data set, select the "Datos Meteorologicos" table and the "Rain" field and check the "Include in Selection" check box. (*Figure 6.13*). The *EML 2 Dataset* actor will reconfigure its ports to match the specified output. In this case, the actor will configure a single output port for the Rain data. To include all data fields in the selected table, select "*" from the drop-down Field menu.

<input checked="" type="radio"/> Meets ALL included conditions listed below <input type="radio"/> Meets ANY included conditions list below					
Table	Field	Data Type	Include in Selection	Operator	Criteria
Datos Meteorol...	RAIN	FLOAT	<input checked="" type="checkbox"/>		
			<input type="checkbox"/>		

Figure 6.13: Configuring the Query Builder to output only Rain data.

The Query Builder can also be used to extract only data records that meet certain criteria: values greater or less than a specified threshold, for example, or strings that exactly match the name of a region or species or other value. To return the date and temperature of all records from the Datos Meteorological data set where the temperature is greater than 20 degrees, use the Query Builder settings displayed in *Figure 6.14*.

<input checked="" type="radio"/> Meets ALL included conditions listed below <input type="radio"/> Meets ANY included conditions list below					
Table	Field	Data Type	Include in Selection	Operator	Criteria
Datos Meteorol...	T_AIR	FLOAT	<input checked="" type="checkbox"/>	GREATER THAN	20
Datos Meteorol...	DATE	STRING	<input checked="" type="checkbox"/>		
			<input type="checkbox"/>		

Figure 6.14: Configuring the Query Builder to return only records in which the temperature is greater than 20 degrees.

When the Query Builder has been used to select particular fields or to specify criteria for the records returned, those settings propagate to the Preview table when it is displayed for the actor. This allows a view of exactly the data that will be used during workflow execution.

6.3 Using Tabular Data without Metadata

In a perfect world, all tabular data sets would be described with metadata, and the *EML 2 Dataset* actor could be used to automatically access and output data fields to workflows. In the real world, data comes in many formats: Excel spreadsheets, old tables created in Microsoft Word, or tables grabbed from Web pages. Kepler workflows can read and process this kind of "raw" data, but because multiple actors are required to do the work, this type of workflow is more complex.

Some actors that often come in handy are: *Binary File Reader*, *Expression Reader*, *File Reader*, *File To Array Converter*, *Line Reader*, *Simple File Reader*, *NexusFileReader* (Table 6.3).

Note that these actors can be used to open either a local or remote data file. In the actor parameters, simply specify the URL of a remote file, or use the Browse button to navigate to the location of a local data set.

Binary File Reader	The <i>Binary File Reader</i> reads a local file path or URL and outputs an array of bytes. The actor can read both binary and ASCII file formats.
Expression Reader	The <i>Expression Reader</i> reads a file or URL, one line at a time, and evaluates each line as a Kepler expression. One evaluated result is output each time the actor iterates.
File Reader	The <i>File Reader</i> actor reads a local file or URL and outputs the contents of the file as a single string.
File To Array Converter	The <i>File To Array Converter</i> actor reads a file or URL, evaluates each line, and outputs an array of the evaluated values. The actor is similar to the <i>Expression Reader</i> actor, except that the <i>File To Array Converter</i> actor outputs all of the evaluated expressions as a single array instead of outputting each value separately.
Line Reader	The <i>Line Reader</i> actor reads a file or URL, one line at a time, and outputs each line as a string.
Simple File Reader	The <i>Simple File Reader</i> reads and outputs the contents of a file as a single string. The actor is similar to the <i>File Reader</i> , except that the <i>Simple File Reader</i> can only take its input from another workflow component via an input port, whereas the <i>File Reader</i> actor can use either a port or parameter.
NexusFileReader	The <i>NexusFileReader</i> actor reads a Nexus file from the local file system and outputs the file content as a string.

Table 6.3: Useful actors for working with tabular data sets with no metadata.

Once the data has been "read" into a workflow via one of the above actors, the data will likely require parsing and further processing before it can be used. See Section 6.3.1 for an example of opening a local data file and preparing it for use in a workflow.

6.3.1 Comma- Tab-, Text-Delimited Files

The plant volume workflow discussed in 6.1—which reads a data set, extracts two columns of data, and plots them—can be recreated to run on data that does not use metadata. In fact, the workflow displayed in *Figure 6.15* is that workflow, recreated to use a simple comma-delimited data table with no EML.

Note that R actors can also be used to access tab or comma delimited data sets. See Chapter 8 for more information about using R.

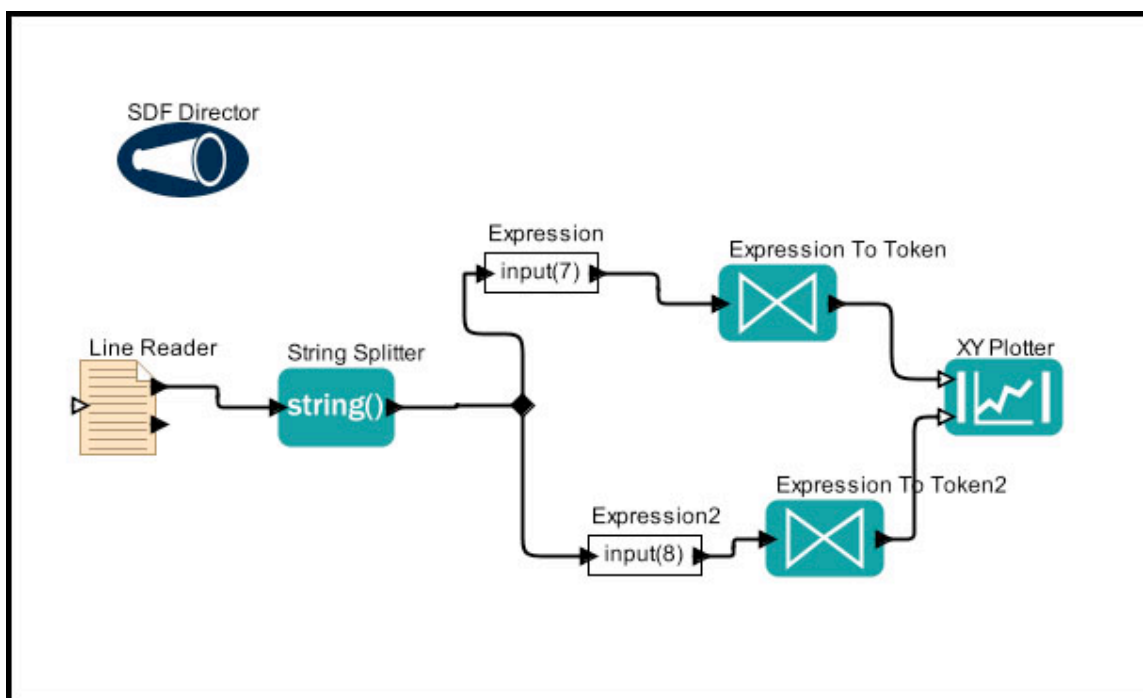

Figure 6.15: Recreating the plant volume workflow to use non-EML data.

The workflow in *Figure 6.15* uses a *LineReader* to read the data file line by line and output each row as a string. Double-click the *Line Reader* actor to specify the name of the data file, as well as the number of lines to skip. In this case, we must skip the first line of the data set, which contains header information instead of observational data (*Figure 6.16*).

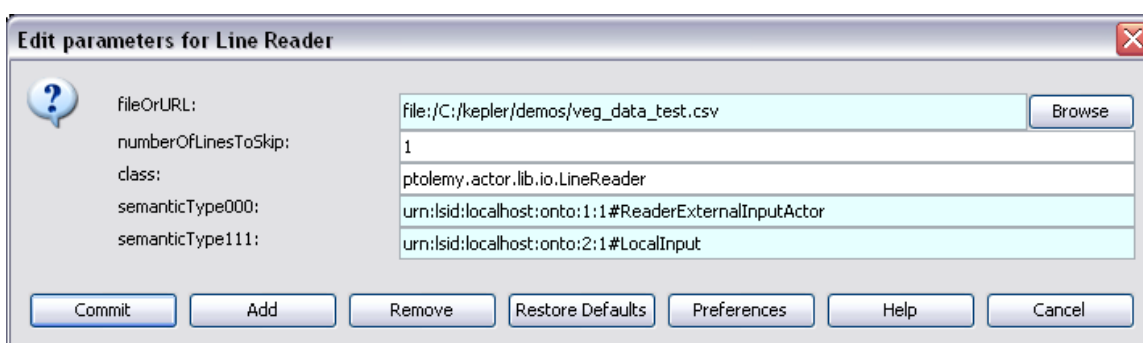

Figure 6.16: Setting the parameters of the *LineReader* actor.

The *Line Reader* actor outputs each row of data to a *String Splitter* actor, which splits the string into segments at points specified by the regular expression parameter ("," in this case, as each value in the data set is separated from the next with a comma). The *String Splitter* actor outputs the segments as an array of strings.

A relation branches the array of string segments to two *Expression* actors, which use the Kepler Expression language to identify the appropriate columns of data. Each of the

Expression actors has a user-defined input port named "input". The expression contained in the actors (specified via the actor's `expression` parameter) references the value passed to the `input` port (the array of strings) using the syntax `input(7)` or `input(8)`. The parenthetical value indicates the array index of the string segment to select (`input(0)` would reference the first column in the data set, `input(1)` the second, etc).

Before the selected columns of data can be graphed by the *XY Plotter* actor, they must be converted from a string to a double—a data type that the *XY Plotter* actor understands. The relevant data types are specified in the Configure Port settings of the *Expression To Token* actor (*Figure 6.17*).

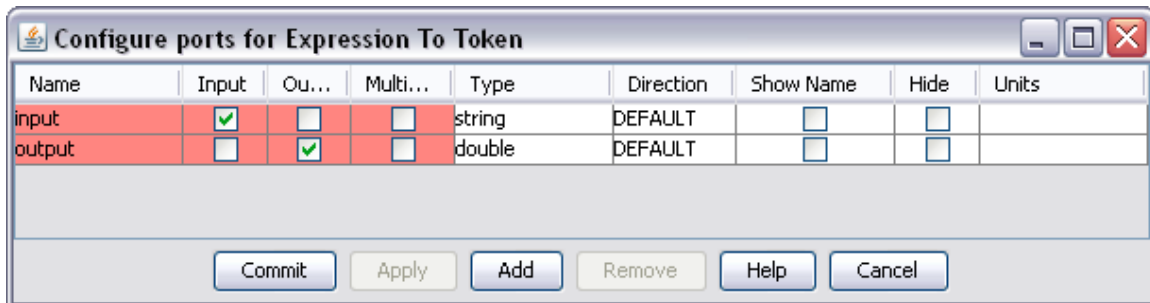

Figure 6.17: Configuring the correct input and output type for the *ExpressionToToken* actor.

Once the data have been converted to doubles, the *XY Plotter* can graph them. See Section 6.2 for more information about how to customize the settings of the *XY Plotter*.

6.3.2 Accessing Data from a Website

Downloading and accessing data from a website is easily accomplished via Kepler's *URL To Local File* actor. This actor receives a URL of a remote file as well as a name that will be applied to it when it is stored on the local system (*Figure 6.18*).

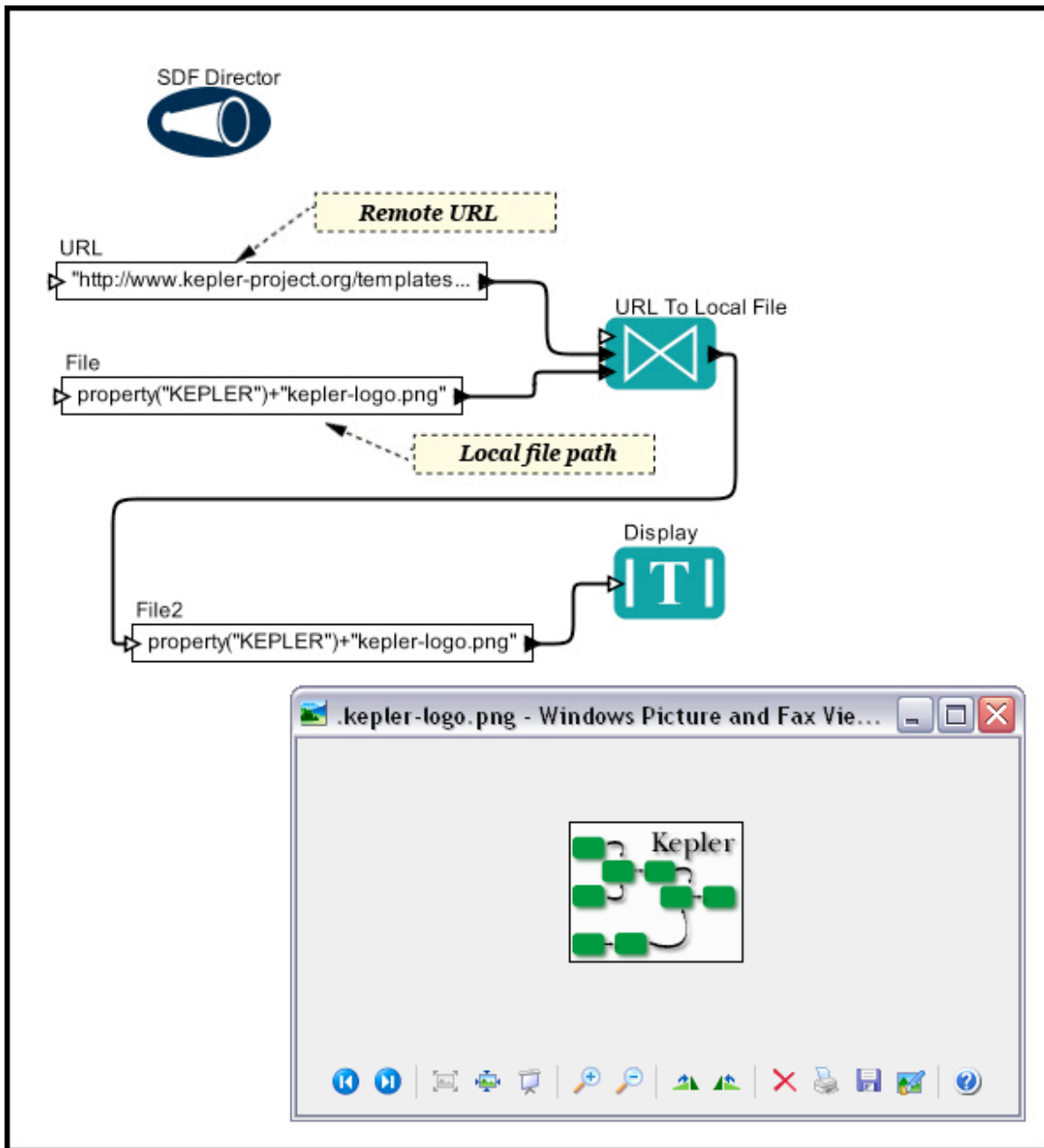

Figure 6.18: Using the *URL To Local File* actor to download a file (the Kepler logo) from a remote website.

Once the remote file has been downloaded and saved to the specified location, the *URL To Local File* actor outputs a Boolean value: true if the operation has been completed successfully; false, if not. The workflow in *Figure 6.18* uses the output of the *URL To Local File* actor as a trigger that alerts the next actor that the file has been downloaded successfully and is ready for further processing, in this case, display.

6.4 Accessing Data Access Protocol (DAP) Sources

Kepler's *OpendapDataSource* actor can be used to access and output any Data Access Protocol (DAP) 2.0 compatible data source. The actor retrieves the specified data and automatically configures its output ports to match the returned variables so that data can be fed to downstream actors.

DAP 2.0 data sources, much like Web pages, are accessed via a URL that references a host and data file as well as (optionally) a specific subset of the data to return. The host server returns the requested data variables as well as information about them: the variable name and data type, a description, and any associated attributes. For more information about DAP, please see <http://www.opendap.org/>.

The *OpendapDataSource* actor must be configured with the URL of the data source as well as an optional constraint expression (CE). The constraint expression specifies the subset of data to return. Using a CE can reduce the system resources required to transmit data or reduce the number of dimensions of a data variable so that the data can be more easily processed in Kepler. The number of dimensions of a variable, similar to the number of dimensions of a matrix, represents the number of rows and columns of data. Because Kepler cannot efficiently process large volumes of multidimensional data objects (i.e., n-dimensional arrays, where $n > 2$), reducing the dimensions is sometimes necessary.

The example parameters displayed in *Figure 6.19* use the CE 'lat' to retrieve only latitude data from a data set collected by the Fleet Numerical Meteorology and Oceanography Center that contains five variables describing wind patterns: degree north (lat), vector wind eastward component (u), Vector wind northward component (v), degree east (lon), and time.

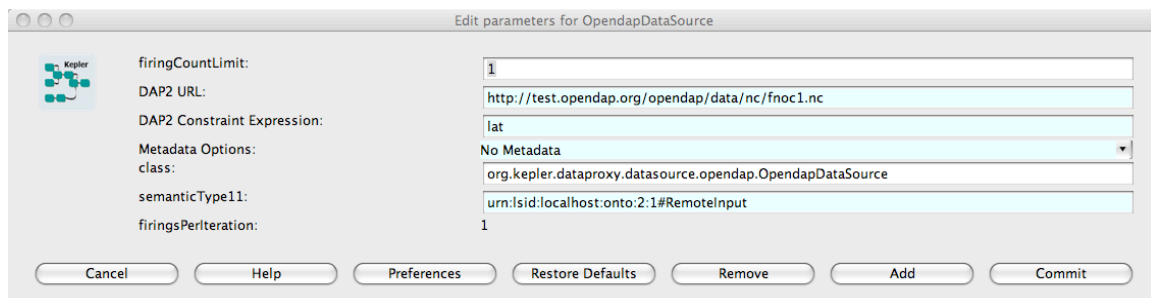

Figure 6.19: Configuring the parameters of the *OpendapDataSource* actor.

Based on the values of the DAP2 URL parameter and DAP2 Constraint Expression, the *OpendapDataSource* actor configures its output ports to match the returned data. In the above case, the actor creates a single output port for the `lat` data (*Figure 6.20*). Note: You must commit a valid URL before the actor will reconfigure its ports and provide access to any data.

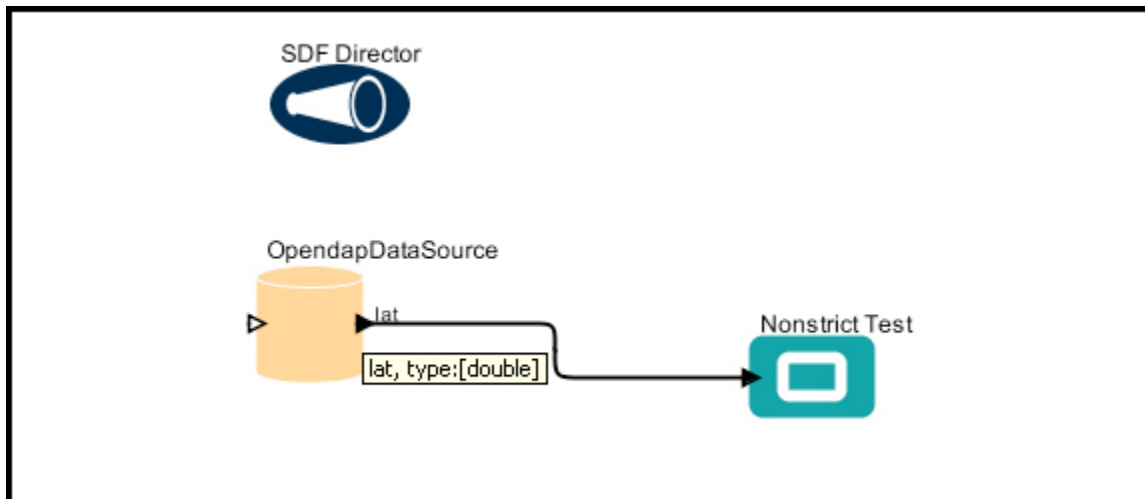

Figure 6.20: The *OpendapDataSource* actor automatically configures its output ports to match the returned data.

Data is returned as a record, which is automatically disassembled and output by the *OpendapDataSource* actor as a one, two, or N (>2) dimensional array, represented in Kepler by either a matrix (one or two dimensions) token, or an array token for dimensions greater than two. To better accommodate N-dimensional arrays, use a constraint expression to reduce the number of data dimensions to one or two so they can be more easily stored and processed. For example, the variable *u* in the FNOC1 data source used in the previous example contains three dimensions (*time*, *lat*, *lon*). The CE '*u*[0][0:16][0:20]' selects only the first element (index 0) for the first dimension (*time*) while requesting all of the remaining elements for the second (*lat*) and third dimensions (*lon*). See the www.opendap.org for documentation about the CE syntax.

Note that the *OpendapDataSource* actor automatically 'disassembles' the top most record of returned data. However, some data sources contain nested hierarchies of records many levels deep. When dealing with those data sources you will need to use the Kepler *Record Disassembler* actor in your workflow to disassemble the nested records.

6.5 Using FTP

The Kepler component library contains several actors that can be used to upload or download files from remote servers: the *FTP Client* actor puts or gets files from a remote FTP server (File-Transfer-Protocol is used to copy files from one computer to another over a network), and the *GridFTP*, *FileFetcher*, *FileStager*, and *UpdatedGridFTP* actors upload and/or download files from Globus servers, which use an authorization certificate generated by the *GlobusProxy* actor (the *GlobusProxy* actor passes a proxy certificate used to connect to the remote host).

The workflow in *Figure 6.22* is used to upload a file from the local directory (the one in which the workflow is stored) using the *FTP Client* actor. The *FTP Client* actor can be used to upload or download a single file, multiple files, or a directory—simply pass the

desired files as a string (e.g., "C:\PleaseUpload\Notes.doc") via the *FTP Client* actor's `arguments` port. If the server requires a username and password, these values must be specified in the *FTP Client* actor's parameters as well. The *FTP Client* actor outputs the file path of the uploaded or downloaded file.

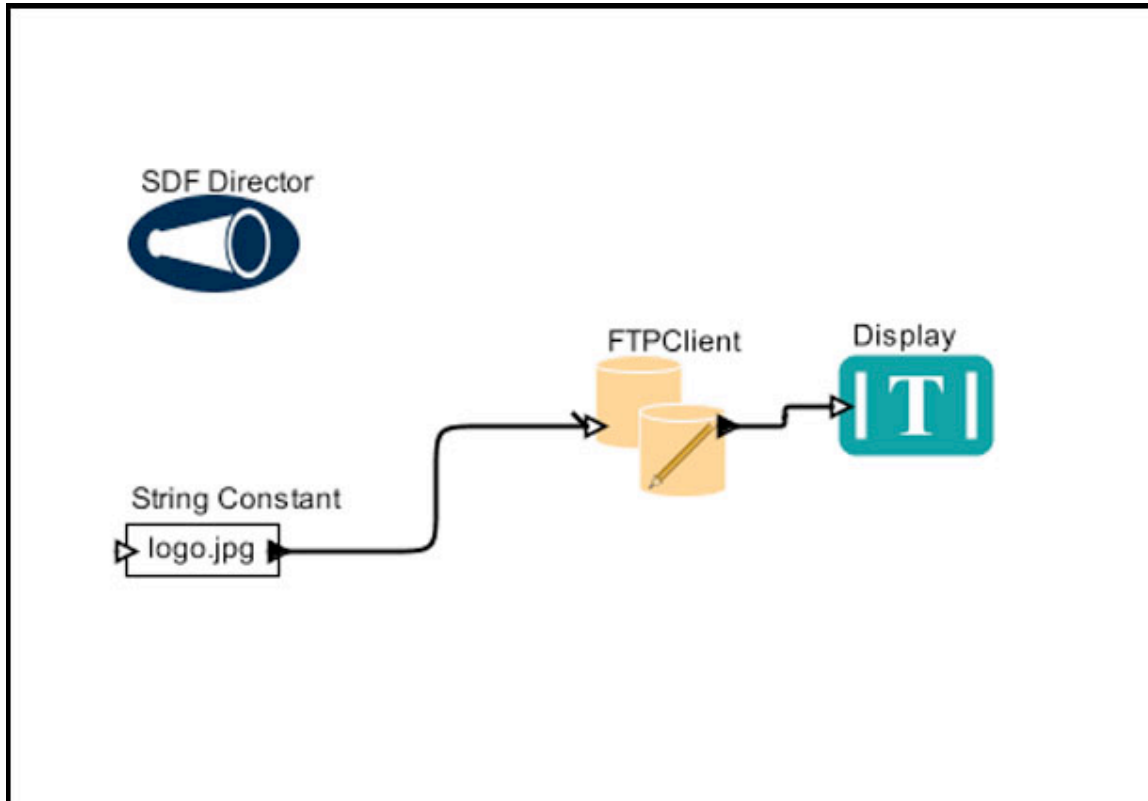

Figure 6.21: A workflow used to upload two files, specified with *String Constant* actors, to a remote server using FTP.

The name of the operation (put or get), the mode (ASC or BIN), the remote host (e.g., dotnet.sdsc.edu), and path (/home/mydocs/), as well as username and password, when relevant, are specified in the parameters of the *FTP Client* actor. Use "asc" (i.e., ASCII) as the mode when transferring plain text files. Use "bin" (i.e., Binary) for everything else (MS Word files, images, etc).

The *FileFetcher* and *FileStager* actors work much like the Get and Put operations of the *FTP Client* actor, only these actors upload or download a set of files from a Globus host. For more information about these actors, please see Chapter 7.

6.6 Using Data Stored in Relational Databases

Kepler has a number of actors that are especially designed to open and close database connections, query databases, and retrieve information. Whether data are stored in an

Oracle database, MySQL, local or remote MS Access, or a number of other supported database formats, information can be accessed by Kepler and used in workflows. To connect to an Oracle, MySQL, local or remote MS Access, DB2, MS SQL Server, PostgreSQL, MySQL, or Sybase SQL Anywhere database, use an *Open Database Connection* actor. The *Open Database Connection* actor opens a database connection using the specified database format and URL, username, and password. Once a database connection has been established, the actor outputs a reference to the connection. Actors downstream in the workflow can use this reference to access the database.

For example, the workflow in *Figure 6.23* uses an *Open Database Connection* actor to open a connection to a remote Oracle database. The actor passes a connection reference to a *Database Query* actor, which uses the connection to pass a query to the database. A *Display* actor displays the query return.

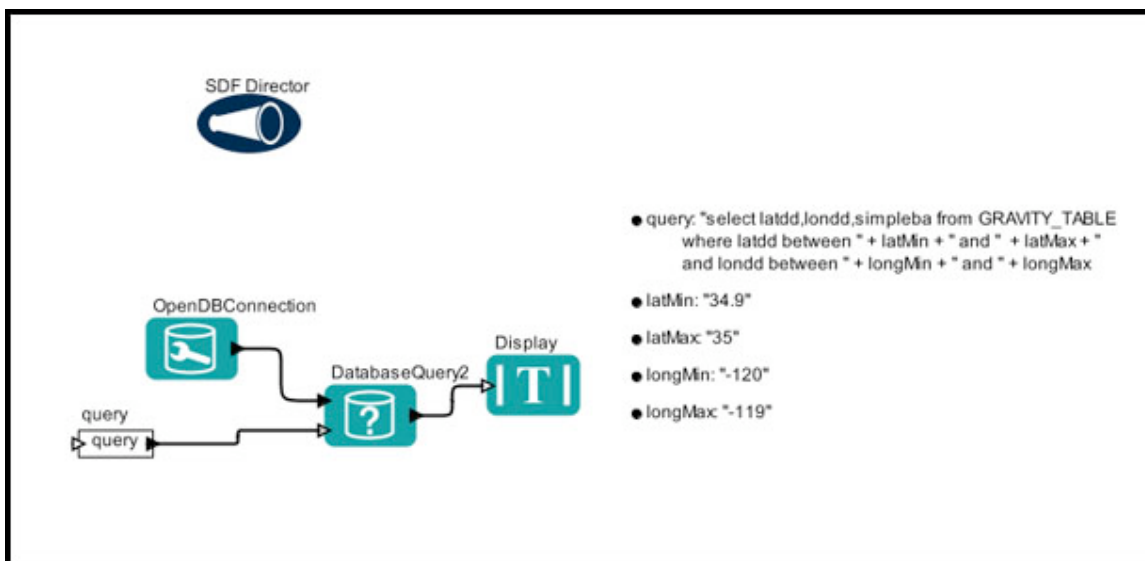

Figure 6.22: Opening a connection to an Oracle database and using the *Database Query* actor to return query results.

The database format and URL are specified in the *Open Database Connection* actor parameters (*Figure 6.24*). The database location is specified in the following format: `host:port:sid`, where `sid` is the name of the database space (e.g., `jdbc:oracle:thin:@129.108.20.225:1521:PDB1`).

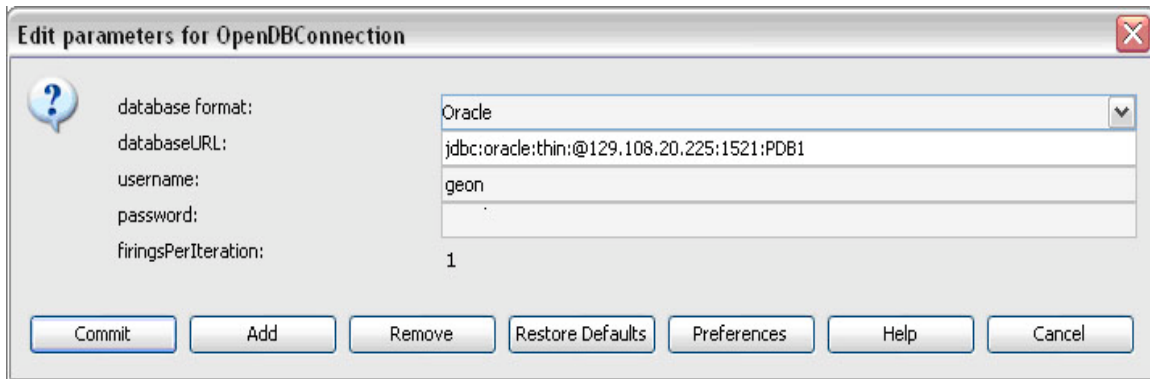

Figure 6.23: The parameters of the *Open Database Connection* actor are used to specify the database format, location, and log in credentials.

The *Database Query* actor can view the schemas in a database. The actor automatically reads the schema definition once a connection to the database has been established (Figure 6.25).

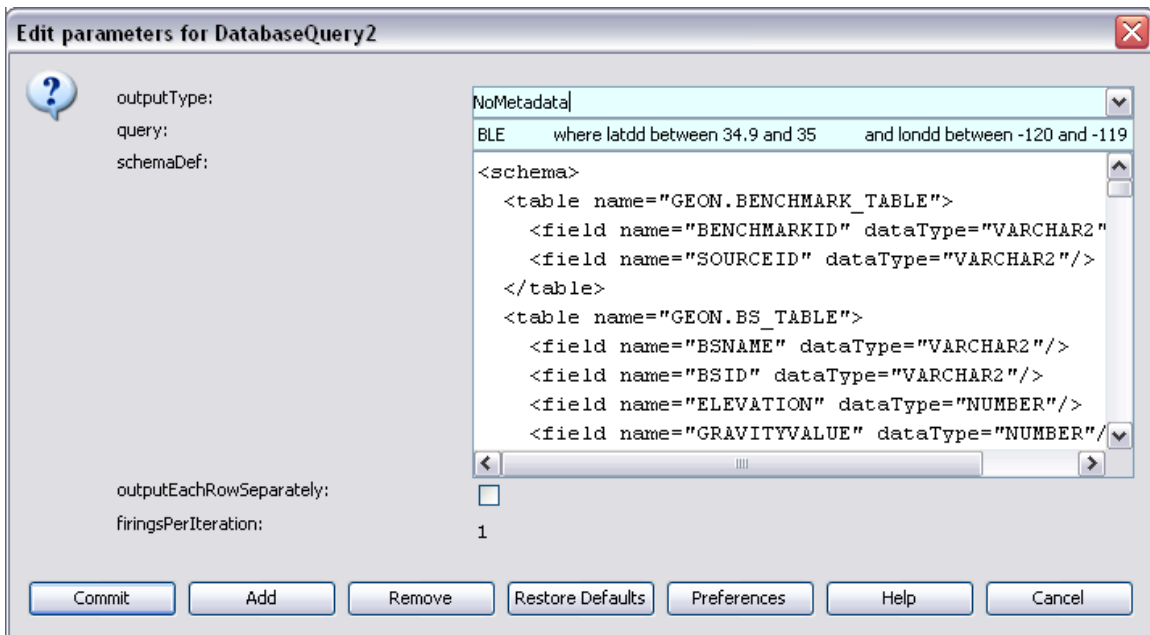

Figure 6.24: Parameters of the *Database Query* actor.

To browse the available database tables and specify a query, right-click the *Database Query* actor and select *Open Actor*. A *Query Builder* window opens (Figure 6.26) Use the *Query Builder* to view the data tables and specify query conditions. The specified query will automatically populate the *Database Query* actor's `query` parameter.

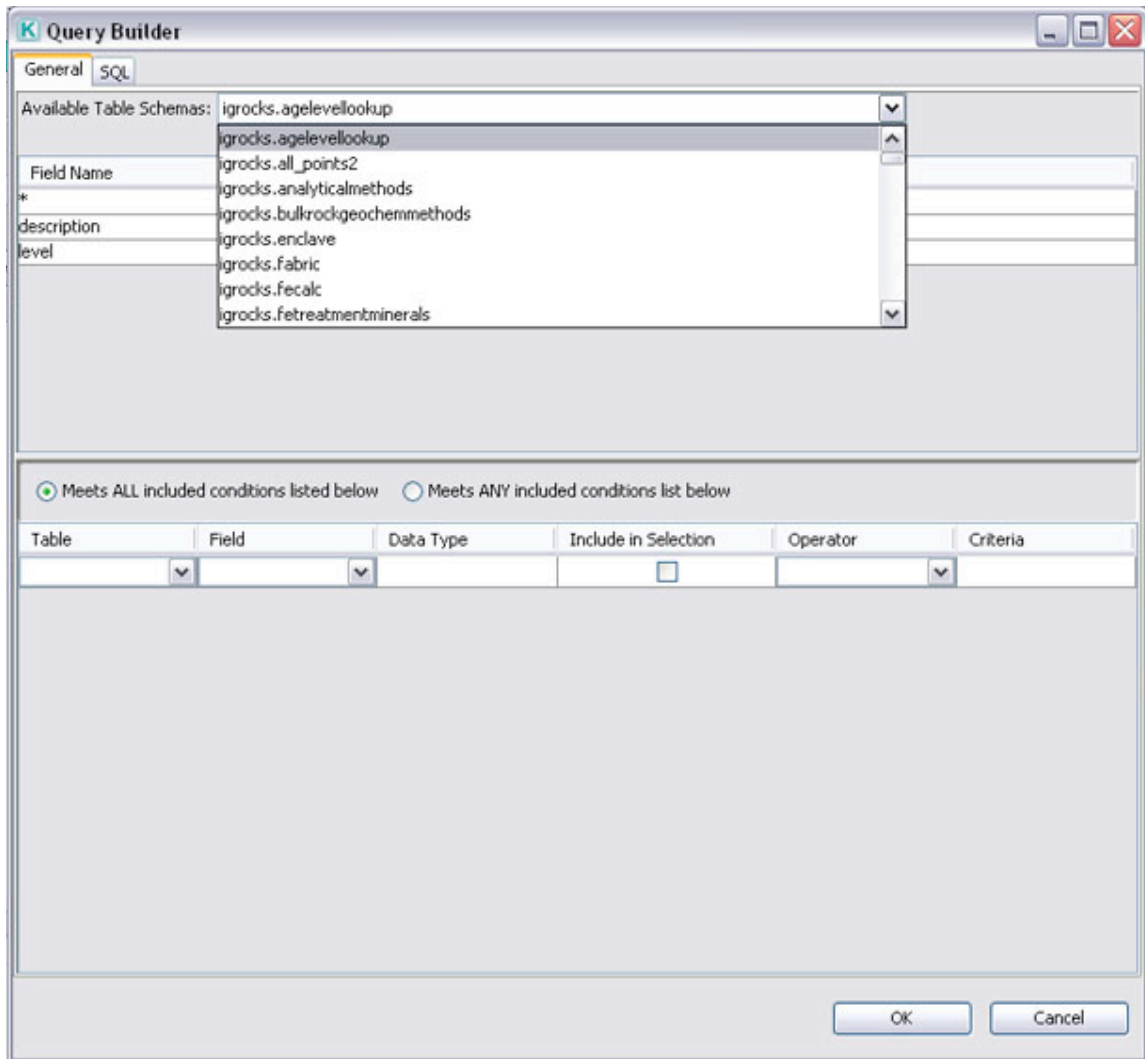

Figure 6.25: Browse database tables using the Query Builder.

6.7 Using Spatial and Image Data

Kepler has a number of actors designed to work with image and spatial data. From a simple jpg image to a high-resolution map of North America, Kepler can process, manipulate, and display a wide variety of data types.

Actors used to process and display image and spatial data are easily recognized by the map icon (spatial data) or the mountain icon (image data) that represents them on the Workflow canvas. A list of useful actors are noted in *Table 6.4*





	GIS/Spatial Display	GIS/Spatial Display actors display geospatial data. Actors: ESRI Shape File Displayer, GML Displayer
	GIS/Spatial Processing	GIS/Spatial Processing actors are used to map and manipulate geospatial data. Actors: Add Grids, Convex Hull, CV Hull to Raster, GDAL Format Translator, GDAL Warp and Projection, Grass Buffer, Grass Hull, Grass Raster, Grid Rescaler, Merge Grids, Rescaler, Interpolate, GridReset, ShowLocations
	Image Processing	Image Processing actors are used to manipulate and convert image files. Actors: ASC To Raw, Convert Image To String, IJMacro, Image Contrast, Image Converter, Image Rotate, Sting To Image Converter, SVG Concatenate, SVG To Polygon Converter
	Image Display	Image Display actors display image files. Actors: Image Display, ImageJ

Table 6.4: Useful image and spatial data actors.

6.7.1 Working with Images

Displaying a locally stored image via a Kepler workflow can be accomplished with one of several useful actors: *ImageJ* or *Image Display*.

The *ImageJ* actor reads an image file name and opens and displays the image along with a toolbar of image-processing options, which can be used to process the image (*Figure 6.27*). The name of the image file can be specified in the actor parameters or via the actor's input port. The actor uses the ImageJ application to open and work with images. ImageJ can be used to display and process a wide variety of images (tiffs, gifs, jpegs, etc.) For more information about ImageJ, see <http://rsb.info.nih.gov/ij/> and Chapter 8 of the User Manual.

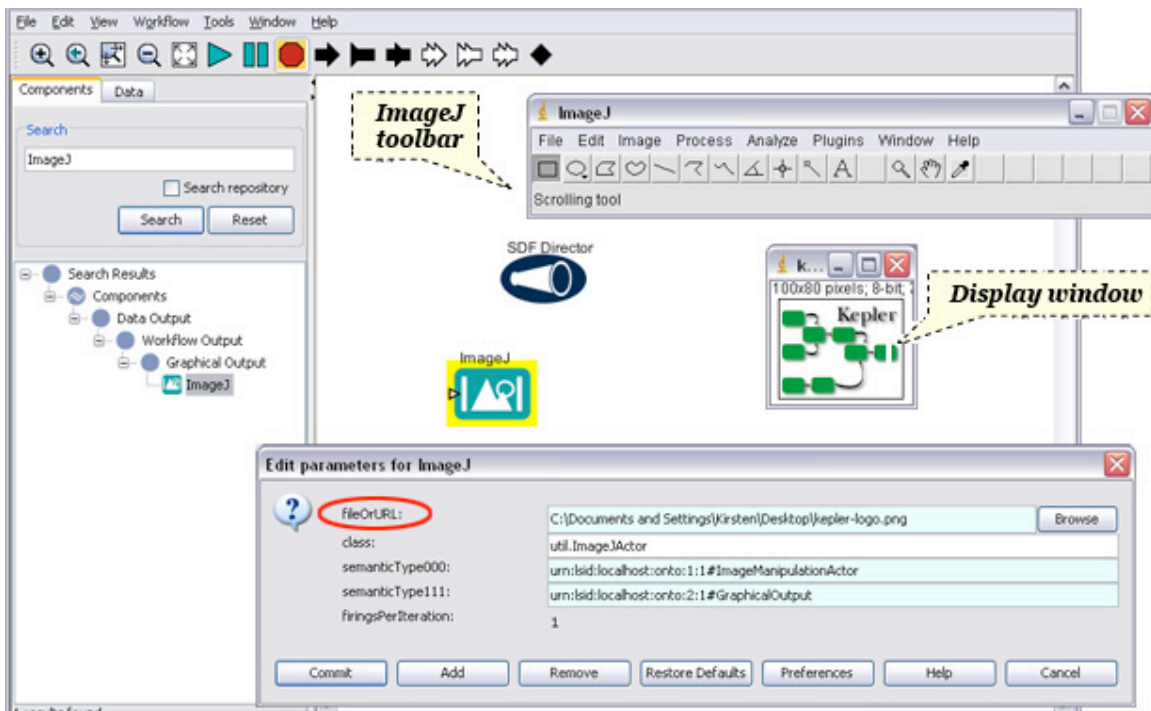

Figure 6.26: Opening an image with the *ImageJ* actor. Specify the path of the image to open in the *ImageJ* parameters or via the actor's input port.

The *Image Display* actor reads an image token and displays the image on the screen. Image tokens can be generated from image URLs using the *Image Reader* or the *Convert URL To Image* actors. These actors read an image path (e.g., `C:\pictures\signature.jpg`), and output the image as an image token, which can be displayed and/or manipulated by other Kepler actors, such as *Image Rotate* or *Convert Image To String* (Figure 6.28).

If the *Image Display* actor receives a sequence of images that are all the same size, it will continually update the display with the new data. If the size of the input image changes, the actor generates a new picture display.

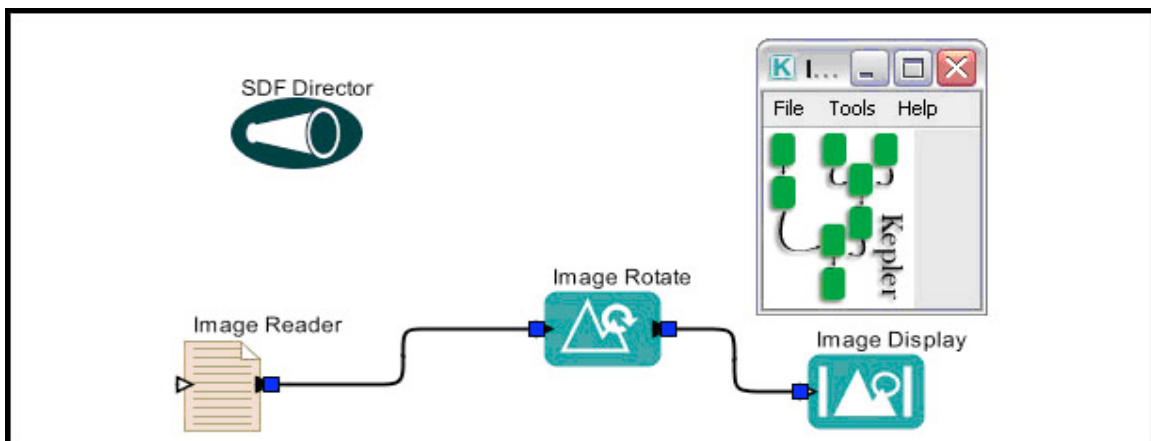

Figure 6.27: An *Image Reader* actor "translates" an image path into an image token, which can be manipulated by the *Image Rotate* actor and then displayed by the *Image Display* actor.

The workflow in *Figure 6.27* uses an *Image Reader* actor to "translate" an image path into an image token, which can be manipulated by the *Image Rotate* actor and then displayed by the *Image Display* actor. The standard Kepler component library contains several actors that can be used to process image tokens; the *IJMacro* actor provides access to an even wider variety of processing tools.

The workflow in *Figure 6.28* uses an ImageJ macro to open an ASCII Grid file, a Geographic Information System (GIS) format that neither the *ImageJ* or *Image Display* actors support. This file format includes GIS information such as the longitude and latitude and number of rows and columns of data at the start of the file, followed by pixel data values in an ascii format. The *IJMacro* actor ignores the GIS information and displays the pixel data as an image. The macro code is pasted into the `macroString` parameter, and the image to process is either specified with a parameter or passed via the input port.

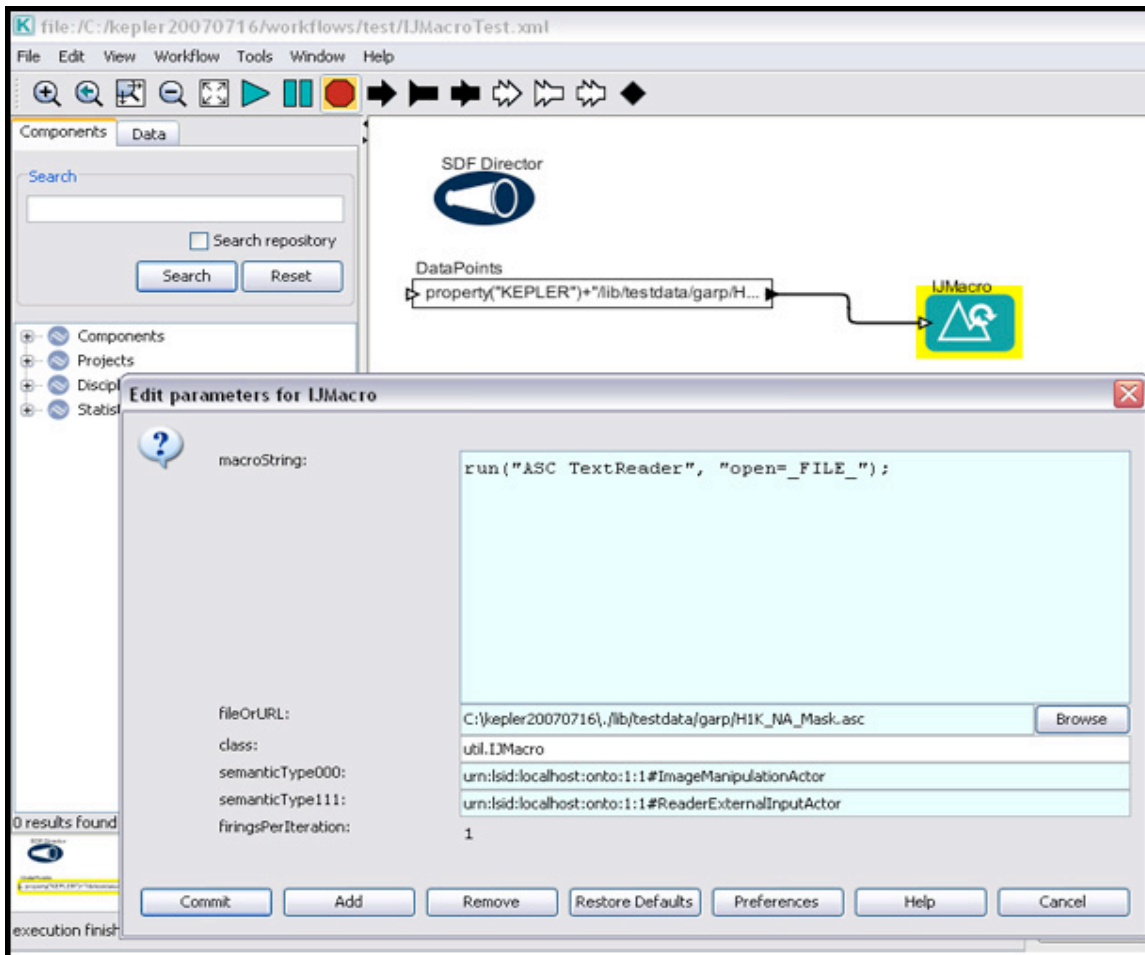

Figure 6.28: The *IJMacro* actor can be customized to execute any ImageJ macros. See <http://rsb.info.nih.gov/ij/> for more information about macros.

The *IJMacro* actor can also be used with an *RExpression* actor to display a PDF file (Figure 6.29).

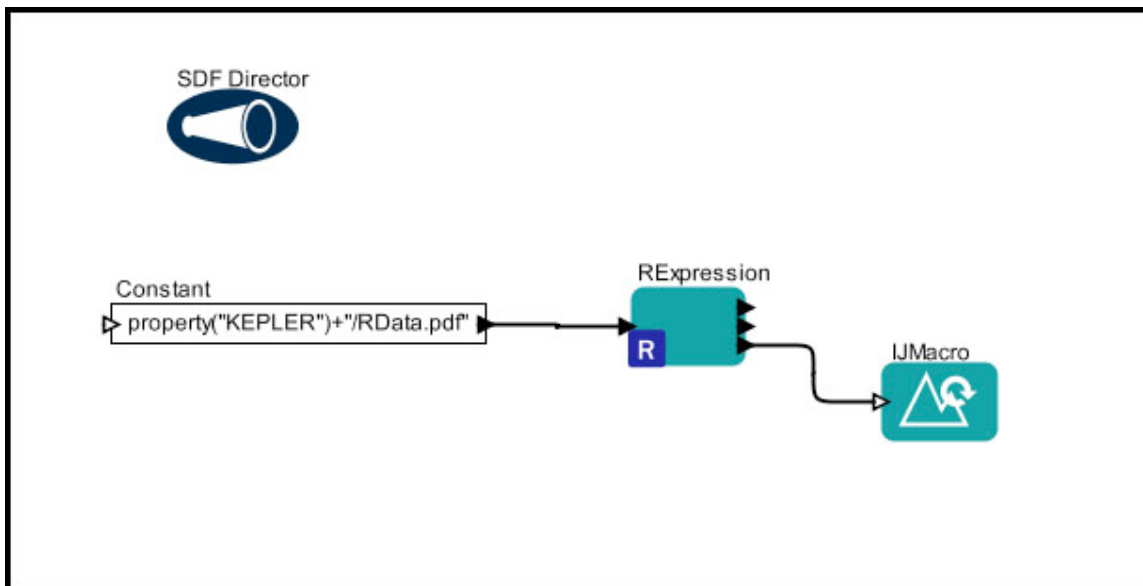

Figure 6.29: Using the *IJMacro* actor to display a PDF file.

In the above workflow, the R function or script used by the *RExpression* actor is:

```
fn <- pdf_file
pdf(file=fn,width=6,height=6)
plot(x <- sort(rnorm(47)), type = "s", main = "plot(x,
type = \"s\")")
dev.off()
```

This R script creates an image in a PDF file format.

The *IJMacro* string is:

```
call("ij.IJ.runPlugIn", "ij.plugin.BrowserLauncher", "fi
le://_FILE_");
```

This script calls the *BrowserLauncher* which, in turn, launches a PDF viewer to display the PDF generated by the *RExpression* script.

See <http://rsb.info.nih.gov/ij/macros/> for a library of macros that can be used with the *IJMacro* actor (you can even use the actor to run a game of Pong!)

6.7.2 Working with Spatial Data

Spatial data comes in a variety of forms and formats—from ESRI Shape files, which contain a set of vector coordinates that represent non-topological geographic data, to ASCII grids (such as the ones used for IPCC climate change data), to GeoTiff, DTED, USGSDEM, and others. Some geospatial data in automated systems are described with Geography Markup Language (GML), an XML-based encoding for geographic information. Geospatial data may also be described using EML. Fortunately, Kepler has a number of actors that can help open, display, and translate the variety of these formats so that they can be compared, added, or otherwise manipulated. As with tabular data, spatial data sets that contain metadata are far easier to work with. We will look at some examples of both EML and non-EML spatial data sets in this section.

Spatial data files—depending on their extent and resolution—can be very large and may require notable time to download and process. Most Kepler actors first check to see if a data set has already been downloaded or if a requested transformation has already been performed before initiating the download or transformation process. If the spatial data file already exists in its desired form, the actors will access the data from the Kepler cache rather than reprocessing the information.

The Ecological Niche Modeling workflows that are shipped with Kepler in the outreach/resources/demos/ENM directory, contain a number of useful examples of spatial data actors and manipulations. Many of these use the Geospatial Data Abstraction Library (GDAL), an open source library of functions for reading and writing geospatial data formats. For example, the GDAL_h1K_NS.xml workflow (*Figure 6.30*) converts two Lambert Azimuthal Equal Area coordinate system projections (one of North America and one of South America) to a format that uses a latitude/longitude system, and then changes the file format from GEOTiff to ASC raster grid. The converted files are rescaled and then stitched together (“added”) to form a single map of the entire Western Hemisphere. The actors in the workflow can be used to convert a wide variety of spatial data files and formats.

Note that the data sets, Hydro1k North American –DEM and Hydro 1k South America-DEM, are described by EML metadata, and can be downloaded from the EarthGrid and output by the *EML 2 Dataset* actor discussed earlier in the chapter.

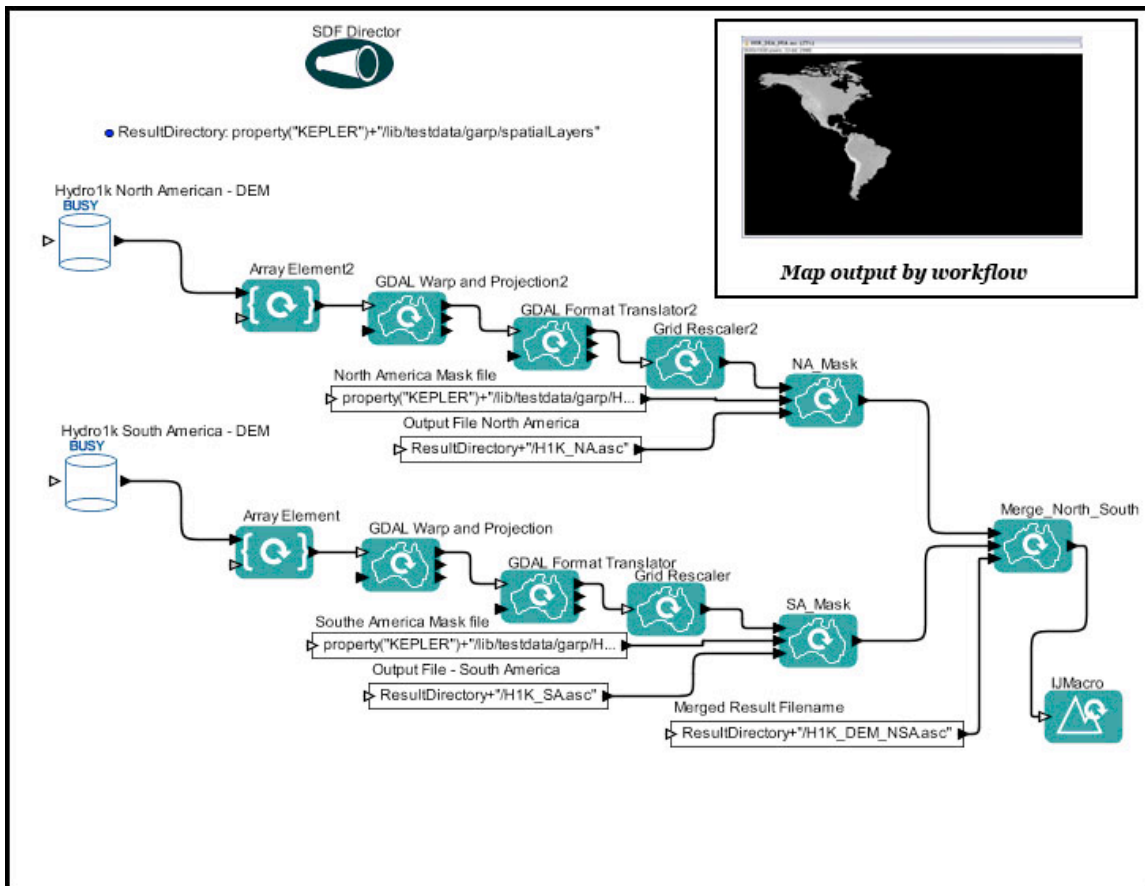

Figure 6.30: The GDAL-h1K_NS.xml workflow. The first time the workflow is opened, the data source actors (*Hydro1k North America DEM* and *Hydro1k South America DEM*) will show a "Busy" status as they download data from a remote server. The initial download may take as long as 30 minutes. Once data is stored in the local cache, the data are more immediately available. Because of the high resolution of the data, this workflow requires 30-45 minutes to execute once the data are downloaded.

The *GDAL Warp And Projection* actor "stretches" or "warps" geospatial projections from one cartographic projection to another (in the GDAL-h1k_NS workflow, the actor converts Lambert Azimuthal Equal Area coordinate system projections to a format that uses a latitude/longitude system). The actor uses GDAL to perform this operation. GDAL is a translator library for raster geospatial data formats. For more information about GDAL, see <http://www.gdal.org/index.html>.

The *GDAL Warp And Projection* actor's `inputParams` and `outputParams` parameters specify the format for the coordinate system (*Figure 6.31*). The parameter values must be of a form used by the GDAL Warp utility. See the `-s_srs` and `-t_srs` parameters of the GDAL Warp utility for more information about accepted forms: <http://www.remotesensing.org/gdal/gdalwarp.html>.

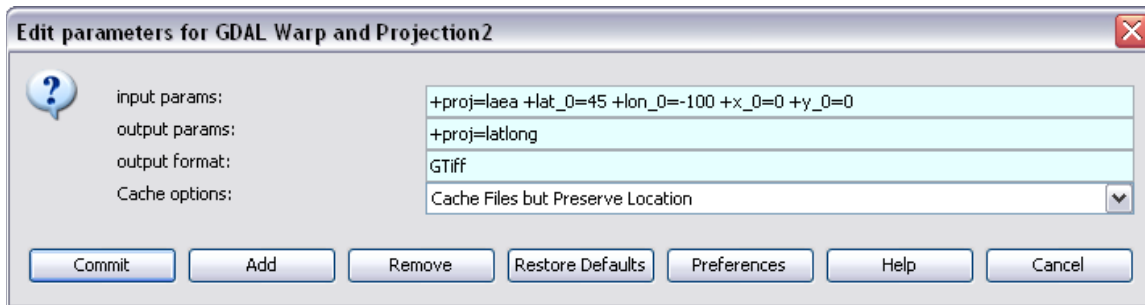

Figure 6.31: The parameters of the *GDALWarpAndProjection* actor. `inputParams` and `outputParams` must be specified in a format used by the GDAL Warp utility.

The *GDAL Format Translator* actor also uses the Geospatial Data Abstraction Library to convert the file format of spatial data (in the GDAL-h1k_NS workflow, the actor converts a GEOTiff to ASC raster grid). The output type, format, and cache options are specified with the actor's parameters (*Figure 6.32*). The `Cache options` specify whether the output should be copied to the cache ("Copy files to cache"), copied to the cache as well as the directory where the input raster is stored ("Cache files but preserve location"), or not cached ("No caching"). If "No caching" is selected, the actor will not cache the translated file and will ignore all previously stored cache items. Select this option to force the actor to perform a translation even if the input file was previously translated and cached.

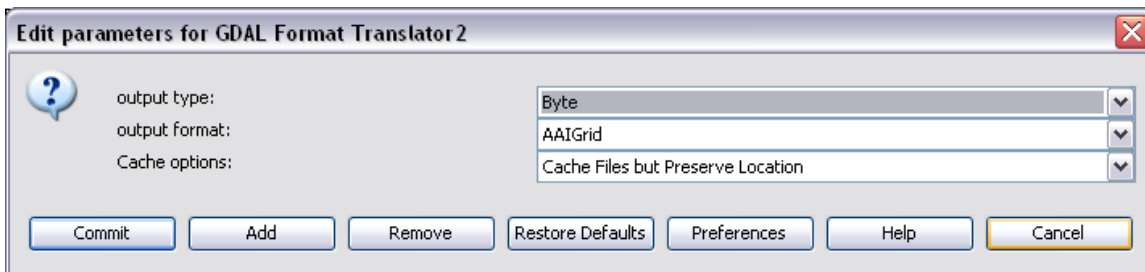

Figure 6.32: The parameters of the *GDALFormatTranslator* actor.

Also of interest are the *Grid Rescaler* actor and the *Merge Grids* actors. The *Grid Rescaler* actor ensures that spatial data files have a consistent resolution and extent. *Grid Rescaler* parameters are used to set the x and y values for the lower left corner of the output grid, the cell size, and the number of desired rows and columns (*Figure 6.33*). Either the "Nearest neighbor" or "Inverse distance" weighted algorithms can be used to calculate output cell values. If the "Use Existing File" checkbox is selected, the actor will check to see if a file with the output file name already exists. If so, the actor skips all actions except for returning the existing file name (i.e., the actor does not "re-translate" the source data). Selecting the "use Existing File" parameter can help avoid lengthy rescaling calculations that have already been completed in prior runs. If the checkbox is not selected, any existing output file with the same name will simply be overwritten. Note also the 'use disk storage' checkbox. If checked, disk files are used for calculations, allowing the processing of very large data grids. If unchecked, all data is placed in memory (RAM), Under this option, calculations are much faster, but a workflow may require more memory than is usually available.

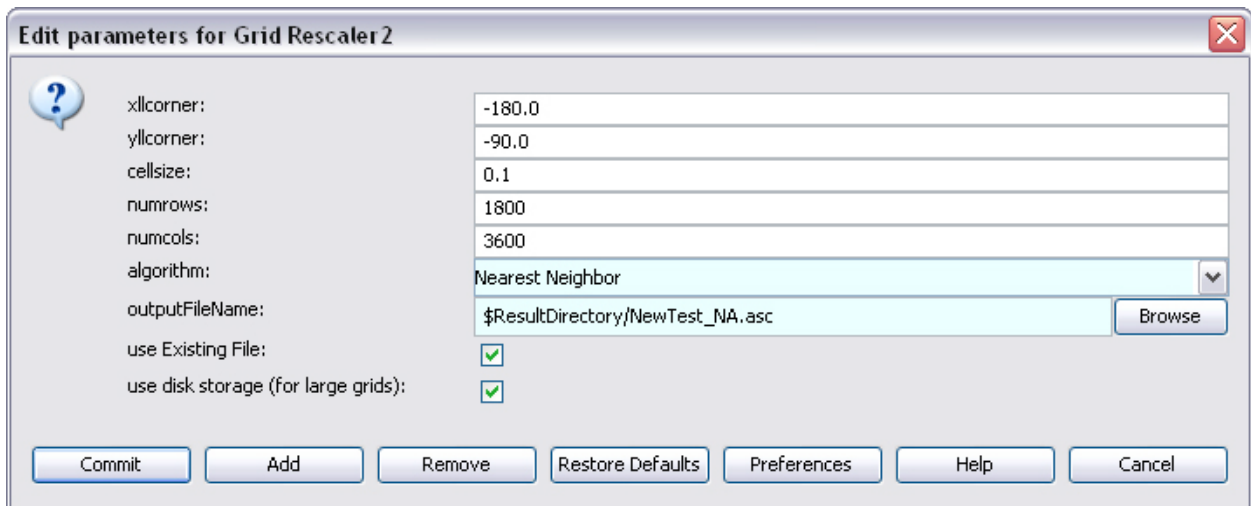

Figure 6.33: Parameters of the *Grid Rescaler2* actor. Note that the "use Existing File" parameter has been selected, instructing the actor to return the file name of an existing output file if one exists.

Merge Grid actors are used to combine two geospatial image files. The actor merges files according to a specified merge-operation (e.g., average, add, subtract, mask, or `not_mask`), and outputs the name of the merged file. The actor can be used to combine several regions into a large region--combining a grid covering North America with one for South America to create a raster grid for the western hemisphere, for example, or to "mask" certain areas of the map that are not relevant for an analyses.

For more information about working with geographic information, see Chapter 8.

6.8 Using Gene and Protein Sequence Data

Some data, such as genetic and protein sequences, are stored in sequence databases, where each sequence is identified by a unique accession number used as a reference. Accessing this type of data from a Kepler workflow involves "passing" the reference for the desired sequence or sequences to the database and parsing the XML format in which the data are stored to extract the information.

The workflow in *Figure 6.34* demonstrates the use of the remote genomics data service to retrieve a genetic sequence. The sequence is then displayed in three different ways, first in its native format (XML), second as a sequence element that has been extracted from the XML format, and third as an HTML document that might be used for display on a Web site. Both of the latter two operations are performed using a composite actor that hides some of the complexity of the underlying operation.

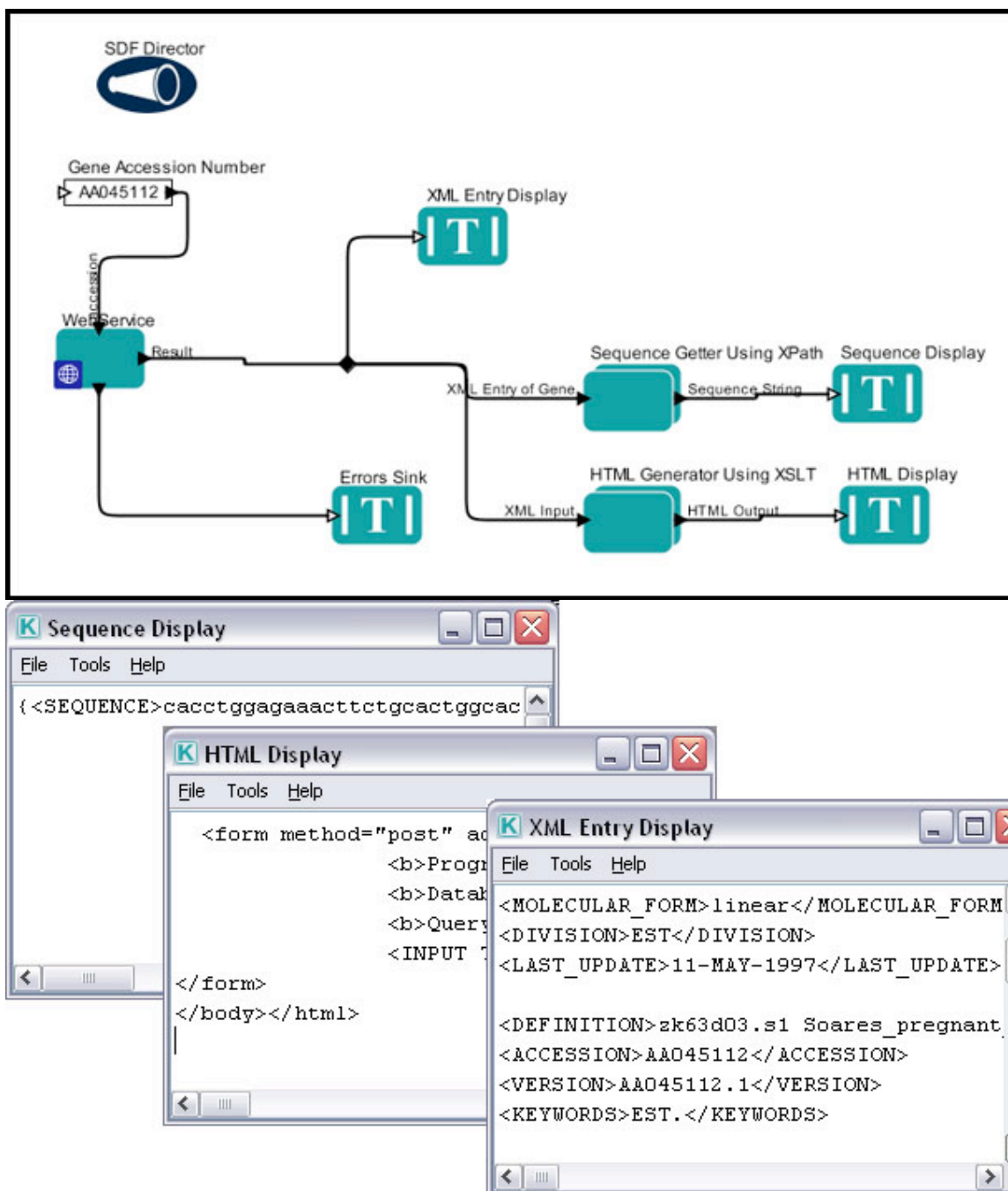

Figure 6.34: Accessing genetic sequence data using a Web Service. The workflow outputs the XML format in which the data is stored, the gene sequence, and an HTML document that might be used for display on a Web site.

The workflow in *Figure 6.34* can be found in the `demos/getting-started` directory, and step-by-step instructions for using and recreating it are included in the Getting Started Guide. For more information about using Web Services, see Chapter 7.

7. Using Remote Computing Resources: The Cluster, Grid and Web Services

Grid computing has emerged as a dominant Internet computing model in the past decade. The word grid was chosen by analogy with the electric power grid, which provides pervasive access to power (Foster & Kesselman 1999), and captures the early grid vision of providing unlimited access to computational power. Sharing is conditional and secured yet dynamic, and includes peer-to-peer access, where individual nodes are capable of acting as both client and server. Data grids enable sharing of data and information resources, while computational grids support data-intensive computing. A service is a component within the model that provides a particular function through a simple remote invocation mechanism. Through the introduction of Web and Grid services, many new resources for different scientific domains are becoming available.^{22,23}

Grid technologies have captured attention because of their capability of providing interactive collaboration between widely dispersed individuals and institutions, global data management services, and sharing of computational resources (Foster *et al.* 2001). The Grid provides mechanisms for harnessing computational resources, databases, high speed networks and scientific instruments, allowing users to build innovative *virtual applications*. Such virtual applications are synthesized by combining different components on multiple computational resources.²⁴ A very common scenario is the following: a user needs to copy (or *stage*) a set of files from one resource (e.g., the local environment) to a remote resource, run a computational experiment on that remote resource, and then fetch the results back to the local environment or copy them to another resource/database.²⁵

Kepler has a number of actors that allow scientists to access remote resources in many useful ways—from the *Web Service* actor, which can execute a remotely stored application, to the suite of SRB actors that facilitate remote data storage, search, and access, to the Globus actors that allow users to send a job to a host for remote processing. In this chapter, we will look at a number of examples of scientific workflows that use various types of grid actors to take advantage of the increased processing, storage capacity, and resources provided.

²² Foster, I. and C. Kesselman (1999). *The Grid, Blueprint for a New Computing Infrastructure*. Morgan Kaufmann Publishers, Inc.

²³ Foster, I., C. Kesselman and S. Tuecke (2001). *The anatomy of the Grid: enabling scalable virtual organizations*. International Journal Supercomputer Applications, 15, 200-222.

²⁴ Abramson, David, Jagan Kommoneni, and Ilkay Altintas. *Flexible IO Services in the Kepler Grid Workflow System*. First International Conference on e-Science and Grid Computing (e-Science'05) pp. 255-262.

²⁵ I. Altintas, A. Birnbaum, K.K. Baldrige, W. Sudholdt, M. Miller, C. Amoreira, Y. Potier, B. Ludaescher. *A Framework for the Design and Reuse of Grid Workflows*. in Proceedings of Scientific Applications of Grid Computing: First International Workshop, SAG 2004, in series Lecture Notes in Computer Science, pp. 119-132. Springer-Verlag GmbH, 2005. ISBN 3-540-25810-8.

Notes: Globus actors introduced in sub-section 7.1.3 and 7.3.2 are not included in default installation of Kepler 2.0. These actors may also be updated according to new Globus Toolkit versions. The detailed documentation on the up-to-date status of these actors and how to add these actors into Kepler 2.0 can be found at <https://kepler-project.org/developers/interest-groups/distributed/technical-documentation/enable-globus-actors-in-kepler-2.0>.

7.1 Data Movement and Management

Access and management of remote data are basic functions in distributed Grid computing. There are several methods for moving data from one location to another, e.g., GridFTP, SRB put/get, *scp*, and others. GridFTP is a secure data transfer protocol optimized for wide-area networks. The SDSC Storage Resource Broker (SRB) is a client-server middleware that provides a uniform interface for connecting to heterogeneous data resources over a network and for accessing replicated data sets, e.g., based on metadata attributes. *scp* is a shell command that allows users to copy files between systems quickly and securely, without the need for expertise in Grid systems. Such a tool can be as helpful in some workflows as any of the other file transfer mechanisms, even for data that will be used by a Grid job.²⁶

In this section, we will look at an example of each of these methods for moving data around on the grid.

7.1.1 Saving and Sharing Data on the EarthGrid

The EarthGrid is a distributed network providing scientists access to ecological, biodiversity, and environmental data and analytic resources. The grid can be used to store data, or to model or analyze it via remote EarthGrid services.

To search the EarthGrid for data sets, type a query into the Search field under Kepler's Data tab. Kepler will automatically download the dataset and output it in the specified format when the data set is dragged onto the Workflow canvas. For more information about downloading EarthGrid data sets, please see Chapter 6.

To upload data to the EarthGrid, use the *EcogridWriter* actor, which writes a data file and the EML metadata describing that data file to a remote grid repository. Ecological Metadata Language (EML) is a standard set of terms and definitions used to describe ecological data²⁷. For example, EML metadata might contain information about a data set's units of measurement, date of collection, location, etc. Although an EML schema document can be quite complex, several easy to use tools have been created specifically to help users create EML: Morpho, available from <http://knb.ecoinformatics.org/software>.

²⁶ <http://users.sdsc.edu/~ludaesch/Paper/sag04-kepler.pdf>

²⁷ EML specification, <http://knb.ecoinformatics.org/software/eml/eml-2.1.0/index.html>

The workflow in *Figure 7.1* is used to write a data file (build.xml) to the EarthGrid. The name of the data file is passed to a *MetadataSource* actor, which integrates EML metadata with a data file and then sends the package to the *EcoGridWriter*.

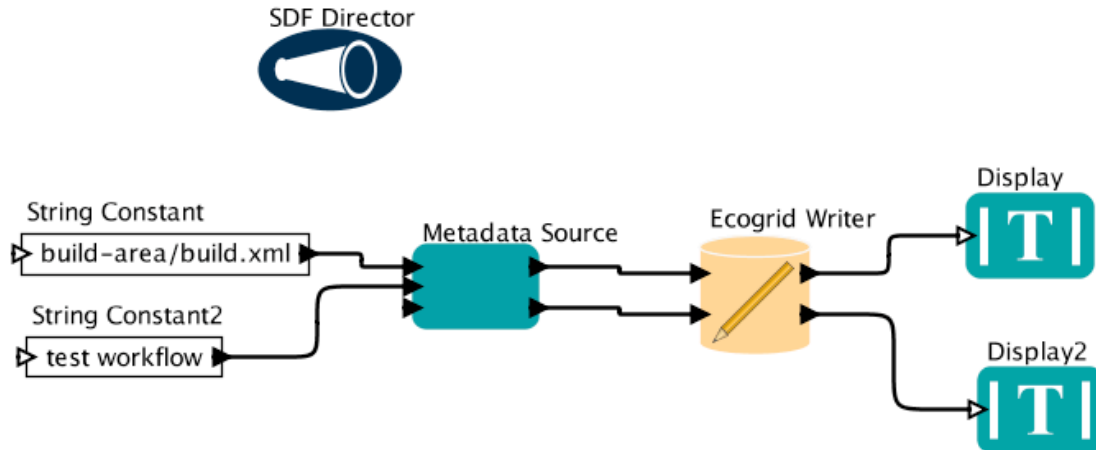

Figure 7.1: Writing a data file to the EarthGrid

In addition to the name of the data file, the *MetadataSource* actor can receive up to two optional strings through its `parameter1In` and `parameter2In` ports. These values, if specified, will replace the substrings `'_PARAM1_'` and `'_PARAM2_'` in the metadata, allowing things like the package title or id to be dynamically changed in a workflow. The EML metadata is pasted into the *MetadataSource* actor's parameters (*Figure 7.2*).

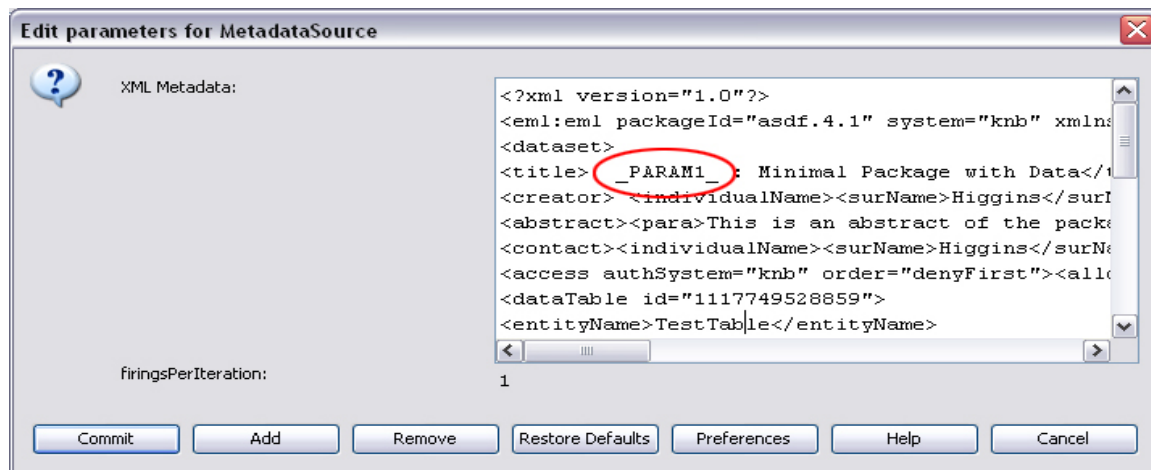

Figure 7.2: EML metadata is pasted into the *MetadataSource* actor's XML Metadata parameter. The text `_PARAM1_` will be replaced with the value passed to the actor via the `parameter1In` port ("Kepler Workflow Title").

The *EcoGridWriter* actor connects to the EarthGrid using a user's credentials, which are input via the actor's parameters (*Figure 7.3*). You must register with KNB in order to

upload data. To register, please go to <http://ldap.ecoinformatics.org/cgi-bin/ldapweb.cgi?cfg=knb>. Type your user name after uid in the `userName` parameter, and your organization after the o and specify your password for the `passWord` parameter beneath.

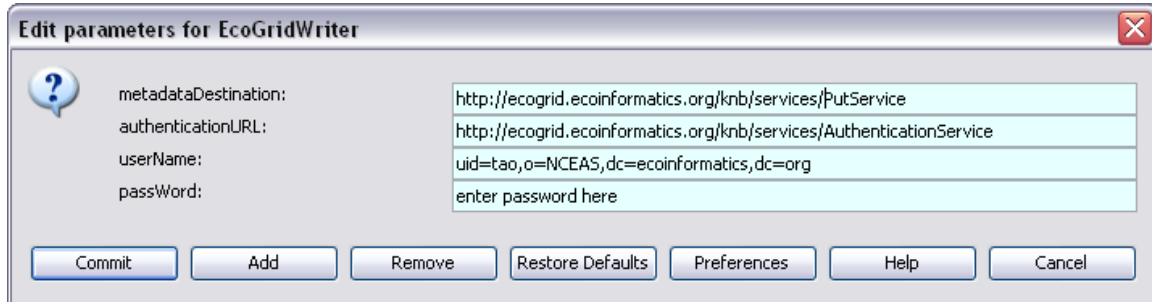

Figure 7.3: Enter username and password to access the EarthGrid

The *EcoGridWriter* actor outputs the doc ID of the metadata and data file (e.g., doc.1190394793046.1 and doc.1190394793078.1), which can be used to reference the data in the future. Once a data set is uploaded, it can be accessed by you or your colleagues via Kepler's data tab. Simply search for the data set by its title, or a portion of the title (*Figure 7.4*).

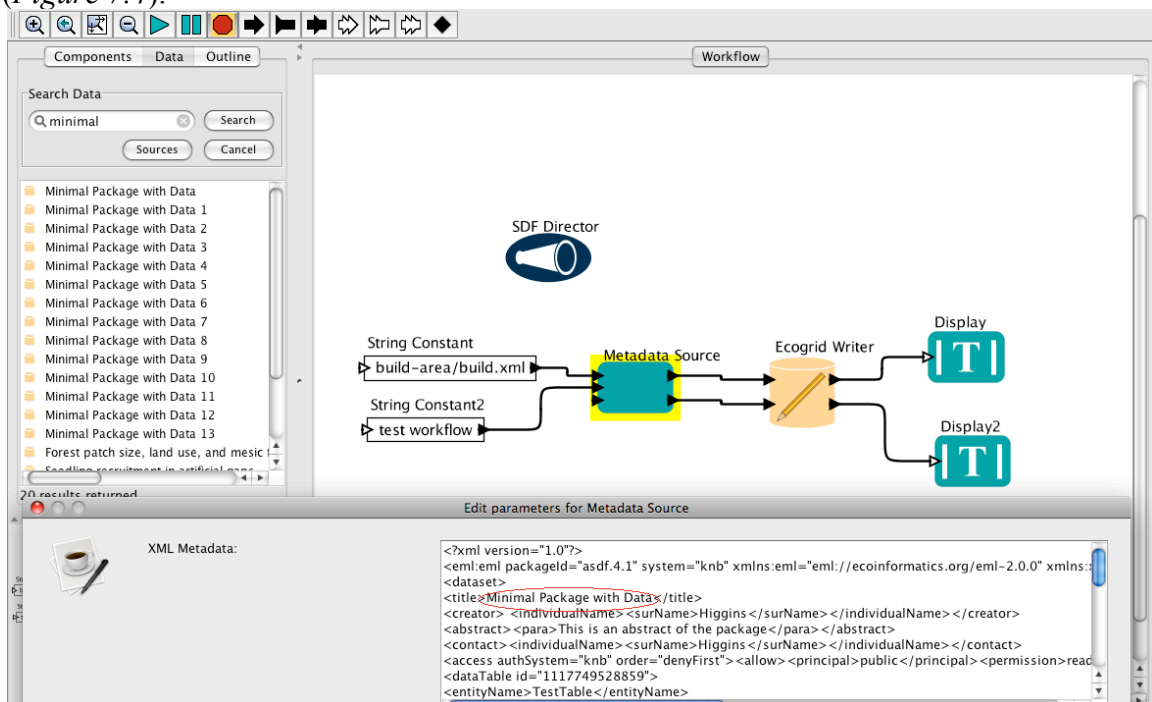

Figure 7.4: Searching for a dataset uploaded to the EarthGrid. In this case, the title of the dataset (specified in the metadata) is "Minimal Package with Data."

7.1.2. Secure Copy (scp)

Sometimes the easiest way to move data from one place to another is with a simple `scp` ("secure copy") command. You can use the *ExternalExecution* actor to call a local `scp`

program, or use the *SSHFileCopier* actor to securely perform the file transfer (Figure 7.5). Note: Windows users may need to install 3rd party software in order to use scp.

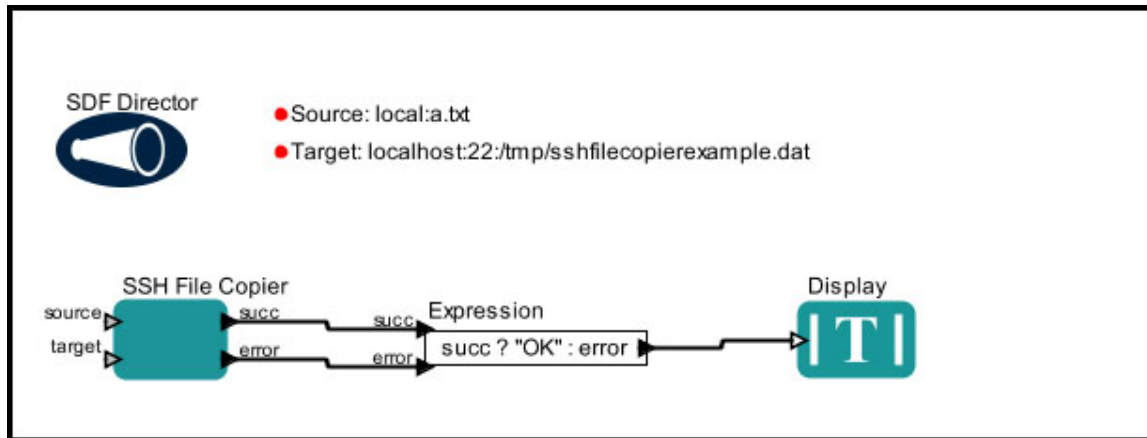

Figure 7.5: Using the *SSHFileCopier* actor to securely copy files.

The *SSHFileCopier* can be used to copy files and directories to or from a path. Either the source or target can be a remote path in the form `[[user@]host[:port]:]path` (e.g., `john@farpc:/tmp/foo.txt` or `john@farpc:2222:/tmp/foo.txt`). The other path must be a local path in the form "local:path" or simply "path" (`local:foo.txt` or `foo.txt`). Both the source and target are specified in the *SSHFileCopier* actor's parameters (Figure 7.6)

Local paths are either relative to the user's home directory (when specified `local:path`) or the current directory (when specified simply by a path).

To copy a directory, you must check the *SSHFileCopier*'s `recursive` parameter (Figure 7.6). If the target path is empty, it is replaced with "."

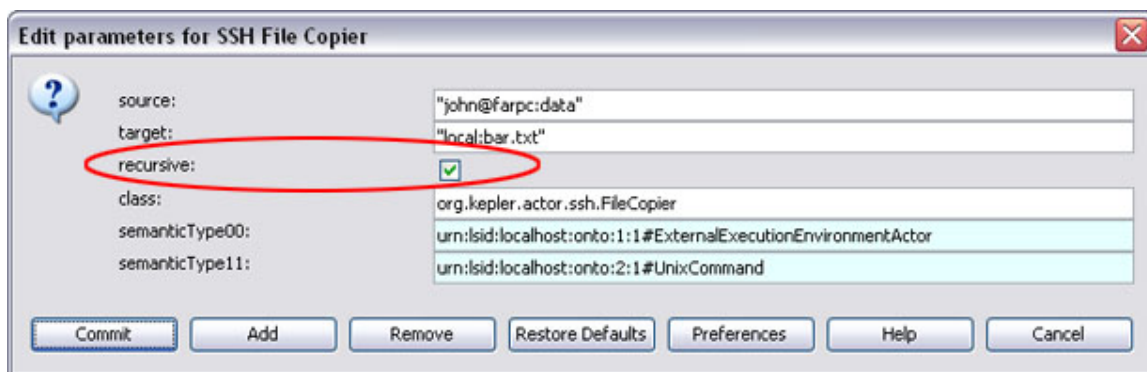

Figure 7.6: Check the recursive parameter if copying a directory.

An actor, called *GenericFileCopier*, is to copy files/directories between a local and remote machine or between two remote machines, using scp, sftp, bbcp or srmlite protocol. The actor uses the SSH protocol to connect to remote hosts. As shown in Figure 7.7, the workflow will copy file from windows machine to remote Linux machine with setting the protocol parameter as 'scp'.

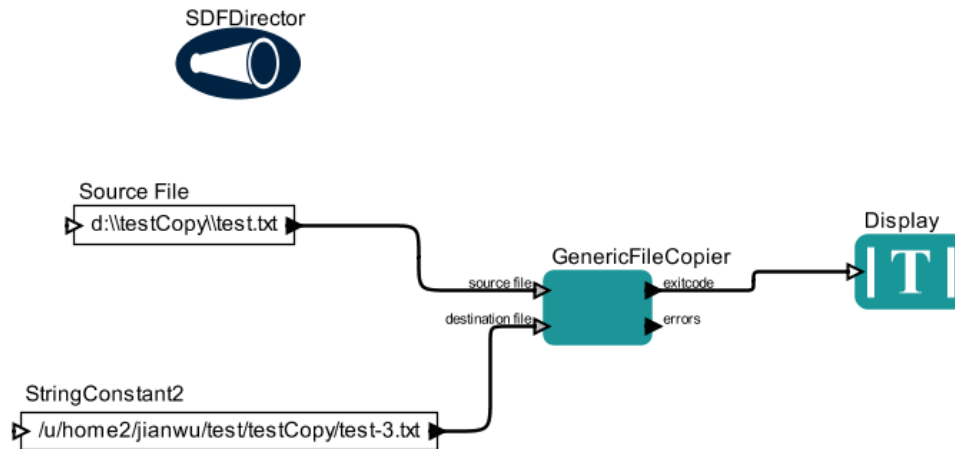

Figure 7.7: Using the *GenericFileCopier* actor to securely copy files.

7.1.3 GridFTP

A leading Grid software is the Globus Toolkit developed by the [Globus Alliance](#), which addresses the common problems that arise when building distributed-system services and applications: security, information infrastructure, resource management, data management, communication, fault detection, and portability. The Toolkit's core services, interfaces and protocols allow users to access remote resources as if they were located within their own machine room while simultaneously preserving local control over who can use resources and when.²⁸

GridFTP is a high-performance, secure, reliable data transfer protocol optimized for high-bandwidth wide-area networks. It is developed by the [Globus Alliance](#) and is based upon the Internet FTP protocol. GridFTP uses basic Grid security on both control (command) and data channels. Other features include multiple data channels for parallel transfers, partial file transfers, third-party (direct server-to-server) transfers, reusable data channels, and command pipelining. For more information, please see the Globus website, http://www.globus.org/grid_software/data/gridftp.php.

The Kepler component library contains several actors that can be used for GridFTP: *FileFetcher*, *FileStager*, *GridFTP*, *UpdatedGridFTP* and *GridFTPCopy*. The *FileFetcher* and *FileStager* actors work much like the Get and Put operations of the *FTPClient* actor, only these actors upload or download a set of files between the local system and a remote Globus host. The *GridFTP* and *UpdatedGridFTP* actors are used to fetch and stage files from and to any Globus host (i.e., not necessarily the local system).

In order to access the Globus machine, the *FileFetcher* and *FileStager* actors must use a proxy certificate provided by the *GlobusProxy* actor (Figure 7.8). A certificate allows the

²⁸ I. Foster. *Globus Toolkit Version 4: Software for Service-Oriented Systems*. IFIP International Conference on Network and Parallel Computing, Springer-Verlag LNCS 3779, pp 2-13, 2006.

actors to access the Grid. To generate a certificate, users must have a Globus user certificate and key. These credentials are issued by a trusted Grid authority, called a Certificate Authority (CA) and are stored on your local system (usually as "usercert.pem" and "userkey.pem"). The *GlobusProxy* actor references these credentials with its parameters (as well as an optional passphrase used to decrypt the key file) and uses them to create a proxy certificate, which is used by all downstream Globus actors.

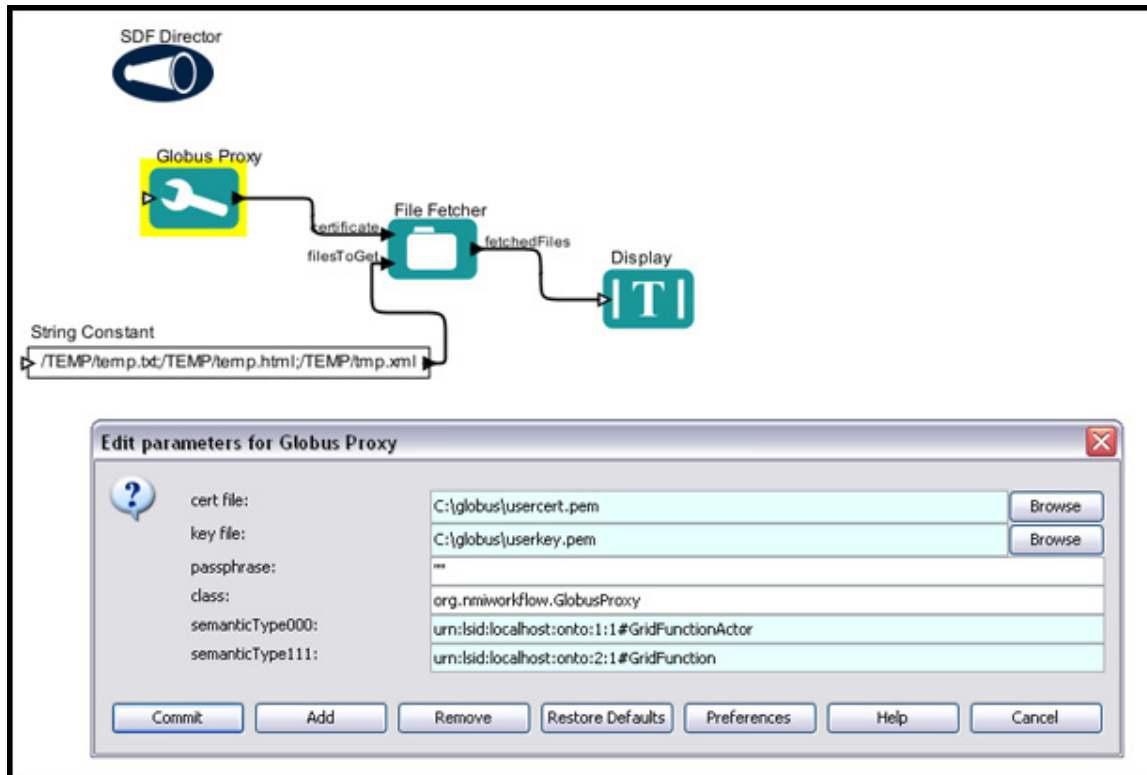

Figure 7.8: The *FileFetcher* actor uses a proxy certificate provided by the *GlobusProxy* actor to fetch files from a Globus server.

In the workflow in *Figure 7.8*, the files to fetch are specified via the *FileFetcher* actor's *filesToGet* port. A *StringConstant* actor specifies the names of three files. Multiple files are separated by a semicolon ";"

The *FileFetcher* actor stores the fetched files in the location specified by its *DestinationDirectoryPath* parameter and outputs the file paths of the fetched files once the operation is complete.

The *GridFTP* and *UpdatedGridFTP* actors can also be used to fetch and stage files to a Globus server, only the files to fetch are specified as parameters (*Figure 7.9*) and the actors can be used to move files between any two Globus hosts. The *Full path to source file* parameter specifies the name of the file to fetch, and the *Full path to destination file* parameter specifies the location in which to put the file. In addition, the *Source hostname* and *Destination hostname* parameters specify the names of the Globus hosts to fetch from and save to, respectively. The

GridFTP and *UpdatedGridFTP* actors also require a certificate generated by the *GlobusProxy* actor. The certificate must be provided via the actor's input port.

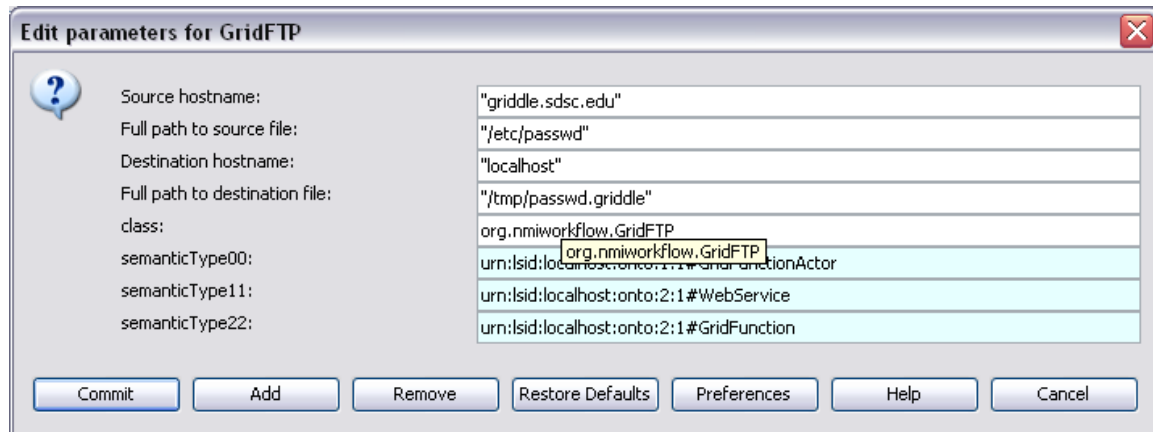

Figure 7.9: The parameters of the *GridFTP* actor.

The parameters in *Figure 7.9* specify that a file (`/etc/passwd`) from the remote Globus host "griddle.sdsc.edu" be fetched and stored on the local system. Note that files can be fetched and placed on any Globus host—one could, for example, fetch files from one remote host and place them on another remote host.

The *GridFTPCopy* actor can also be used to fetch and stage files to a Globus server, only the files to fetch are specified as parameters (*Figure 7.10*) and the actors can be used to move files between any two Globus hosts. The difference between this actor with the above actors is that the credential needs to be given by *MyProxy* actor (the detailed *MyProxy* actor can be found at section 7.3.2.1). The Full path to source file parameter specifies the name of the file to fetch, and the Full path to destination file parameter specifies the location in which to put the file. In addition, the Source Host and Destination Host parameters specify the names of the Globus hosts to fetch from and save to, respectively. The output of the actor is the full path to destination file.

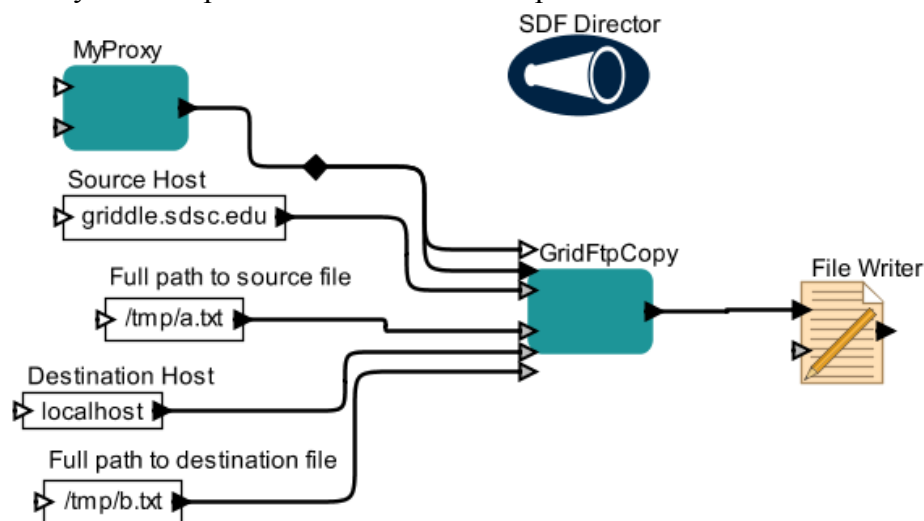

Figure 7.10: The *GridFTPCopy* actor uses a proxy certificate provided by the *MyProxy* actor to fetch files from a Globus server.

7.1.4 Storage Resource Broker (SRB)

The SDSC Storage Resource Broker (SRB) is a Grid storage management system providing data access, transfer, and search functionality, as well as persistent archiving (usually for files). Every user has a home directory (or "collection") where the user can read, write, or create-sub collections; users grant permission to their home collection to other users. In addition, project-level collections can be shared by users and groups. SRB collections use a "logical name space" that maps logical paths consisting of collections (directories) and individual data objects (files) to physical files stored on different devices. Users see and interact with the logical paths, and the physical location is handled by the SRB system and administrators. Files and datasets have associated metadata, which determine where the data are physically located and who has access to the data, as well as user-defined metadata, which contains information about the data. For more information about SRB and its integration with Kepler, see http://www.sdsc.edu/srb/index.php/Main_Page and <http://www.sdsc.edu/srb/index.php/Kepler>.

To get data from an SRB system, use the *SRBGet*, *SRBStreamGet*, or *SRBGetMetadata* actors. The *SRBGet* actor fetches data files from an SRB system, the *SRBStreamGet* actor reads a file stored on an SRB system and outputs its contents as a series of bytes, and the *SRBGetMetadata* actor retrieves and outputs (as a string) user-defined metadata for a SRB dataset or collection. To upload data to an SRB system, use the *SRBSPut* or *SRBStreamPut* actor.

Users must have a valid SRB account in order to connect to the SRB system and use the SRB actors. To obtain an account, contact your local SRB system administrator. If you do not have a local administrator, applications can be made to srb@sdsc.edu. To use these actors, users usually also need make sure that both the SRB host server and resource server, which are specified at the *srbHost* and *srbDefaultResource* attribute of the *SRBConnect* actor, are running. One way to test these servers is using SRB client commands <http://www.sdsc.edu/srb/index.php/Scommands>.

All workflows using SRB actors require an *SRBConnect* actor, which connects to a SDSC Storage Resource Broker (SRB), where users can upload, download, or query data. The *SRBConnect* actor connects to an SRB file system and returns a reference to the system. This connection reference can be propagated to all actors accessing the SRB workspace, allowing the actors to access the SRB system. The actor requires the user to specify account information in the connection parameters (*Figure 7.11*).

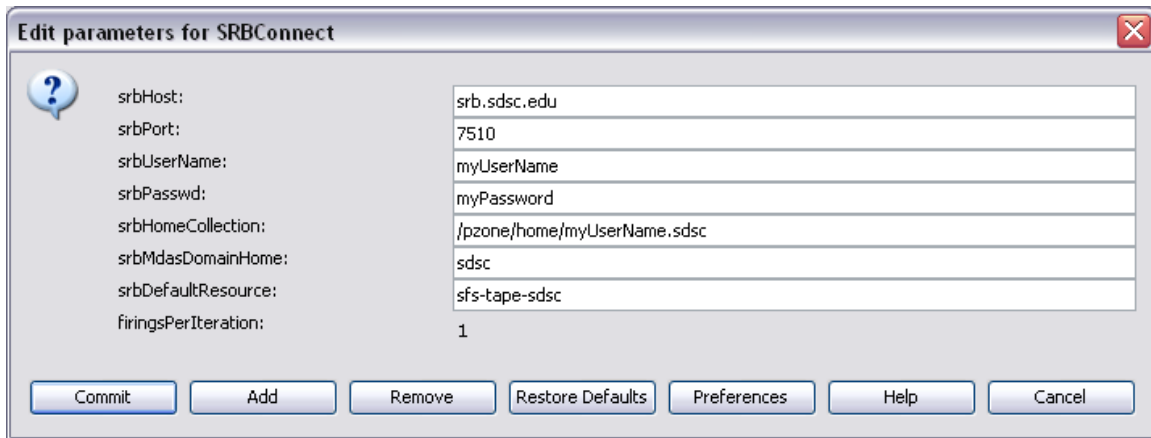

Figure 7.11: Example of *SRBConnect* actor's parameters and settings.

The `srbHost`, `srbPort`, `srbUserName`, `srbPasswd`, `srbDomainHome`, and `srbDefaultResource` parameters specify user account settings, which are emailed to users when the SRB account is first set up. If you need this account information, please contact your local SRB system administrator. The `srbHomeCollection` parameter specifies the path to the home collection. Each SRB-registered user has a home collection, where the user can read, write, create-sub collections, and grant access permissions. In general, the SRB home collection is specified in the following format: `/home/<username>.<domain>`.

The workflow in *Figure 7.12* uses an SRB connection generated by an *SRBConnect* actor to copy a file from an SRB file system to a local directory. If successful, the *SRBSGet* actor outputs the status (i.e., "success") via its `exitCode` port. The file path of the fetched file is output by the `fetchFiles` port.

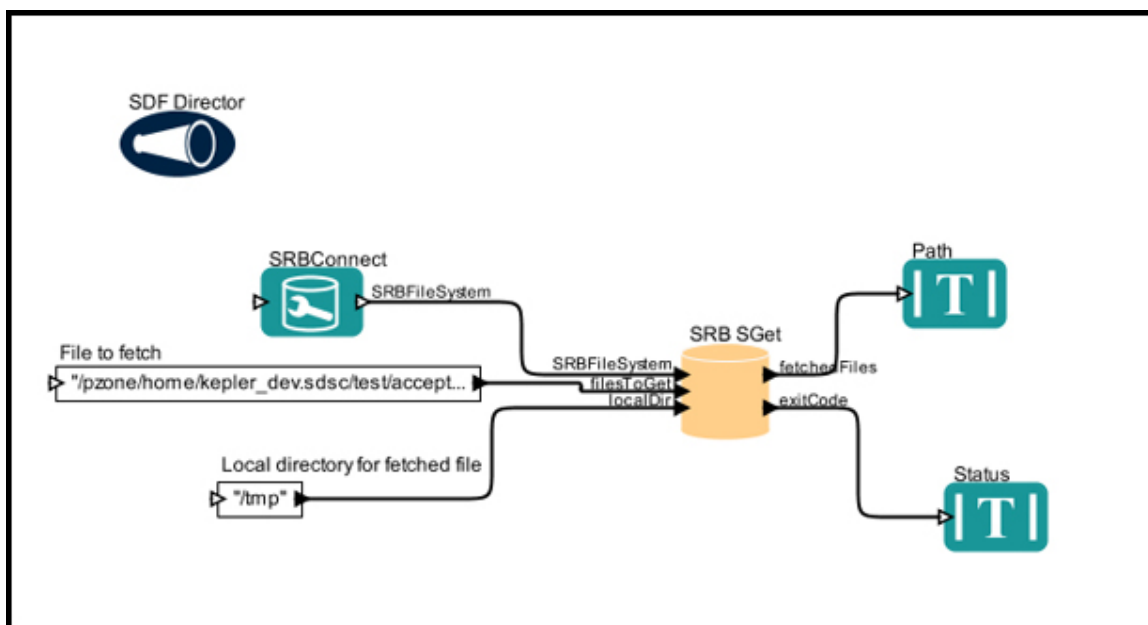

Figure 7.12: A workflow that copies a file stored on an SRB host to the local system. The path to the file to fetch is specified by a *StringConstant* actor labeled "File to fetch".

The *SRBStreamGet* actor works similarly to the *SRBGet* actor, only it outputs the SRB file as a sequence of bytes. To view the user-defined metadata associated with a data file stored on an SRB host, use the *SRBGetMetadata* actor. Metadata describes the data and might contain information about unit systems used by the data, for example, or the extent of the geographic area from which it was collected.

To write data to an SRB host, use the *SRBSPut* or *SRBStreamPut* actor (Figure 7.13).

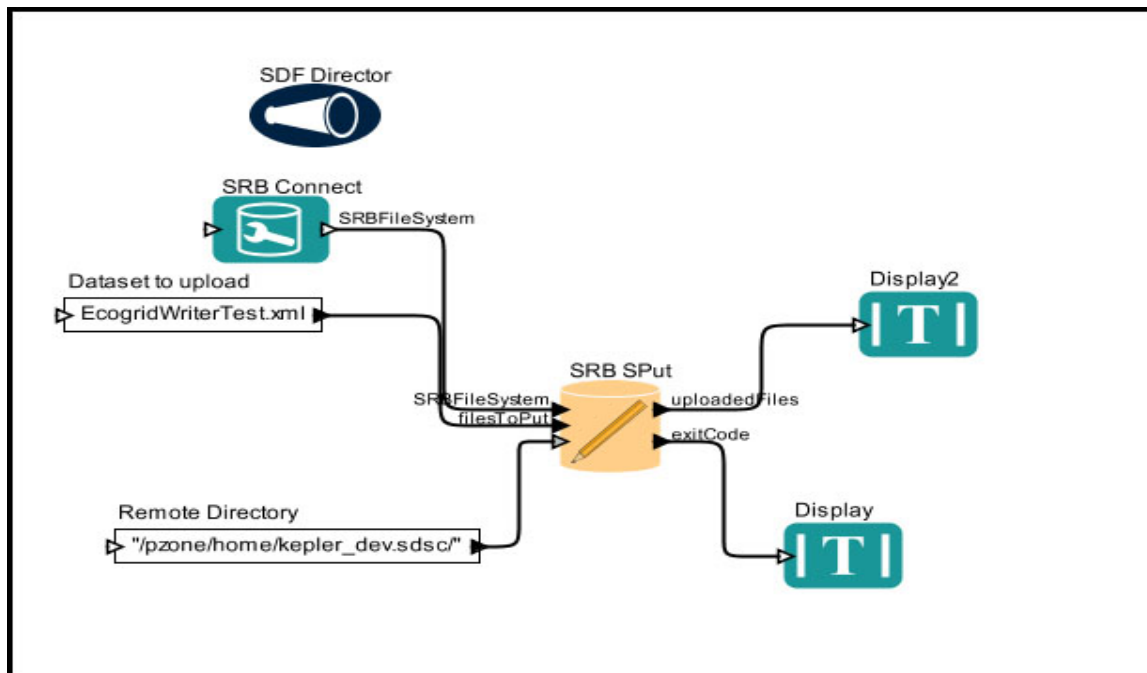

Figure 7.13: Using the *SRBSPut* actor.

In the above workflow, the *SRBConnect* actor is used to create a connection to the SRB server. You must have an SRB account. To request an account, or if you require help with an existing account, please see the [SRB website](#).

The name of the dataset to upload to the remote server as well as the directory in which to place it are specified with constant actors (*Dataset to upload* and *Remote Directory*, in the above workflow). Once the dataset has been uploaded, the *SRBSPut* actor will output the new remote file path as well as the status (e.g., "Success").

The suite of SRB actors also includes components designed to help manage SRB systems and execute commands such as registered Web services. The *SProxy* and *SRBProxyCommands* actors execute a proxy command on a remote SRB system and output the command result along with an exit status. Only a predefined set of SRB commands can be executed via the *SProxy* actor: list directory, copy or move a directory or file, remove, replicate, create or remove a directory, change permissions (to execute a broader range of commands, use the *SRBProxyCommands* actor). The *SProxy* actor executes the command specified by its parameters (Figure 7.14). Parameters qualified by

parenthetical comments only apply to specific commands, e.g., `SlS` (for list directory) or `Srm` (for remove).

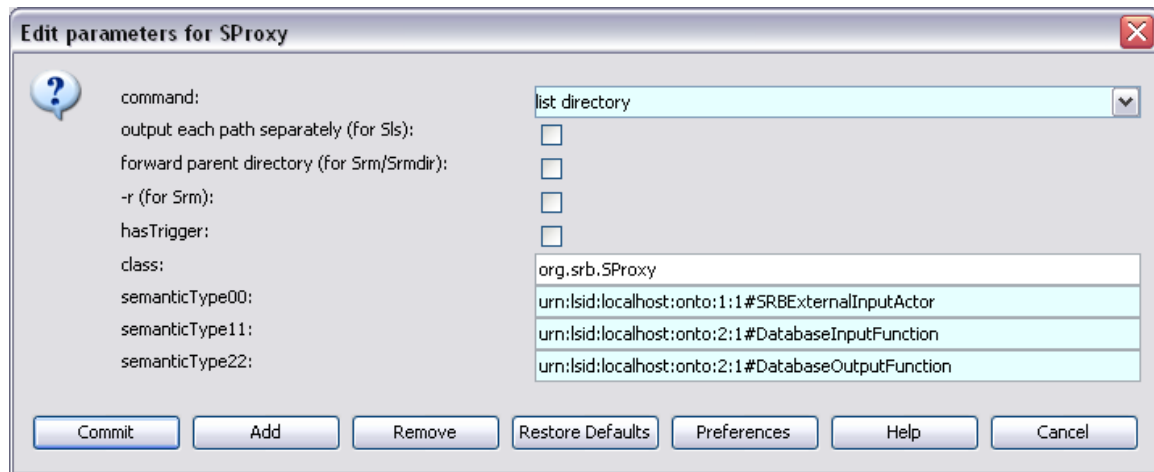

Figure 7.14: The parameters of the *SProxy* actor.

Sproxy actor commands include:

List directory: List the contents of a remote directory. The path to the directory must be input as a string (e.g., `/data/2007/`). By default, contained file paths are output as an array. To output each file separately, select the `output each path separately (for SlS)` parameter. When this parameter is selected, one file path will be output with each iteration.

Copy/Move: Copy or move files to a new path. The actor outputs the new file paths and recursively copies/moves directories. The path to the original file or directory must be input as a string (e.g., `/data/2007/`). In addition, the new path must be specified via the `newPath` port. To reveal this port, right-click the *SProxy* actor and select `Configure Ports` (Figure 7.15). Check the `Show Name` checkbox beside the `newPath` port. The actor outputs an array of the new file paths.

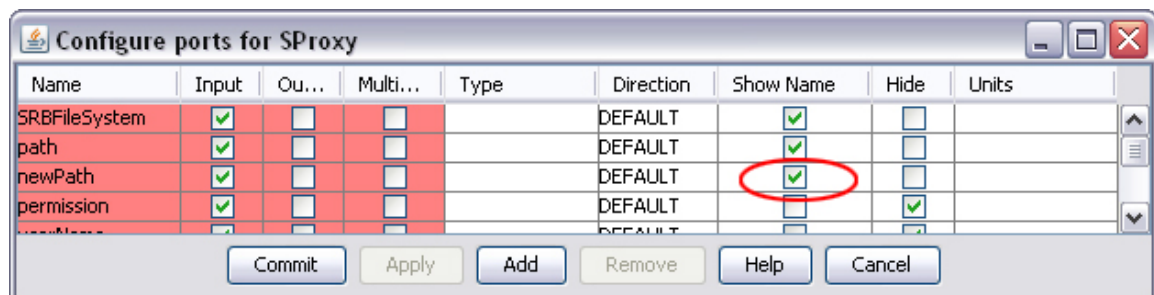

Figure 7.15: To reveal the `newPath` port, check the `Show Name` box beside the port.

Remove/Remove directory: Remove files/directories. To remove directories recursively, select the `-r` (for `Srm`) parameter. Select `forward parent directory (for Srm/Srmdir)` to output an array of the removed file and

directory paths. The path to the original file or directory must be input as a string (e.g., /data/2007/).

Create directory: Create a new directory. The name of the new directory must be input as a string (e.g., /data/2007/). The actor outputs the new directory path.

Replicate: Replicate a file/directory to a new resource. Replication is the process of making a replica, or copy, of something. Replication in SRB does not distinguish between the original and the copy. Therefore it is possible to delete the original and continue working with the copy (also called Migration). Replication in SRB serves a number of purposes: disaster protection and recovery, migration to new storage technologies, and load balancing.²⁹ The path to the original file or directory must be input as a string (e.g., /data/2007/). In addition, the new path must be specified via the `newPath` port. To reveal this port, right-click the *SProxy* actor and select Configure Ports (*Figure 7.15*). Check the Show Name checkbox beside the `newPath` port. The actor outputs an array of the new file paths. The actor outputs the path of the new resource.

Change mode: Change the permissions of a file or a directory. Access permissions allowed are write (w), read (r), all (a), annotate (t), none (n), give curator (c) permission or change owner (o).³⁰ The path to the file or directory must be input as a string (e.g., /data/2007/). In addition, a new permission string (e.g., rw), user name (of the user being granted permissions) and `mdasDomain` (of the person granting the permissions) must be specified via ports. The `mdasDomain` (metadata domain) contains password information (e.g., ~.srb/.MdasAuth). To reveal the relevant actor port, right-click the *SProxy* actor and select Configure Ports (*Figure 7.15*).

The workflow in *Figure 7.16* uses an *SProxy* actor to list the contents of the `kepler_dev` home directory on an SRB system. An *SRBConnect* actor is used to connect to this system and output a reference to it. The *SProxy* actor reads the SRB reference as well as the name of the directory to list ("`/pzone/home/kepler_dev.sdsc/`"), and outputs an array of contained files and directories.

²⁹ Nirvana website, <http://www.nirvanastorage.com/index.php?module=htmlpages&func=display&pid=32>

³⁰ SRB Manual, <http://www.sdsc.edu/srb/index.php/Schmod>

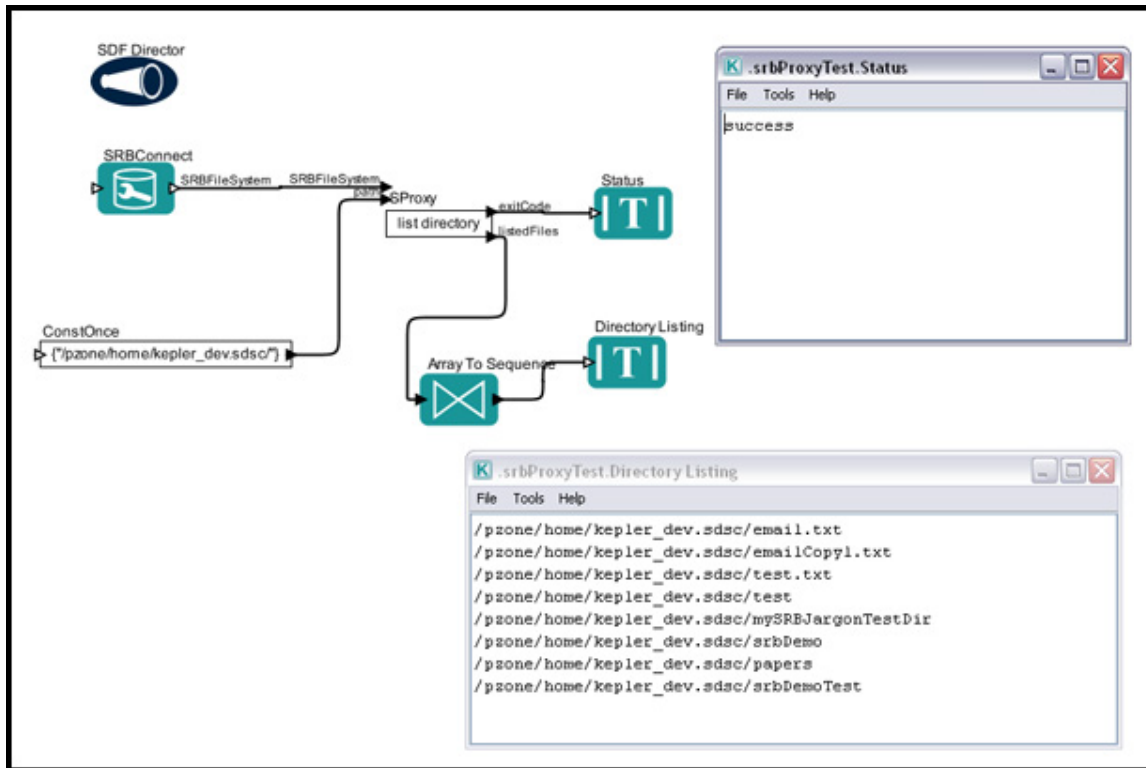

Figure 7.16: Using *SProxy* actor to pass a command to an SRB system.

The *SRBProxyCommands* works much like the *SProxy* actor, only it can be used to execute any command that is available on the server side. The actor requires an SRB connection reference, a command to execute, and command arguments. Multiple arguments should be separated by a space. In addition, the name of an output file can also be specified via either an input port or the actor's parameters.

For more information and examples of Kepler and SRB, please see the Kepler/SRB user documentation, <https://code.kepler-project.org/code/kepler-docs/trunk/legacy-documents/user/KeplerSRBUserManual.pdf>.

7.1.5 Integrated Rule-Oriented Data System (iRODS)

iRODS™, is a data grid software system developed by the **Data Intensive Cyber Environments (DICE) group** (developers of the **SRB**, the Storage Resource Broker), and collaborators. The iRODS system is based on expertise gained through nearly a decade of applying the SRB technology in support of Data Grids, Digital Libraries, Persistent Archives, and Real-time Data Systems. iRODS management policies (sets of assertions these communities make about their digital collections) are characterized in iRODS Rules and state information. At the iRODS core, a Rule Engine interprets the Rules to decide how the system is to respond to various requests and conditions. iRODS is open source under a BSD license. For more information about iRODS and its integration with Kepler, see <https://www.irods.org/> and <https://www.irods.org/index.php/Kepler>.

The *DataGridFileTransfer* actor has functionality similar to the SRB/IRODS commands, namely Sget, Sput, iget, and iput. *DataGridFileTransfer* allows users to copy one or more objects from one local/remote file system to another local/remote file system. The following actor expects as input a reference to local or remote file systems support by the Jargon API³¹. This reference connection is created from the source and destination URL values. Currently available file system URLs are, file:///myDir/myfile.txt, irods://username:password@myhost.org:1247/myDir/myfile.txt, srb://username.domain:password@myhost.org:5544/myDir/myfile.txt, or ftp and http urls.

The workflow in *Figure 7.17* uses an *DataGridFileTransfer* actor to transfer a local file to a directory at one iRODS server. The *SProxy* actor reads the file from sourceURL and transfer it to destinationDirectoryURL. Its outputs is an array of transferred files, and exitCode.

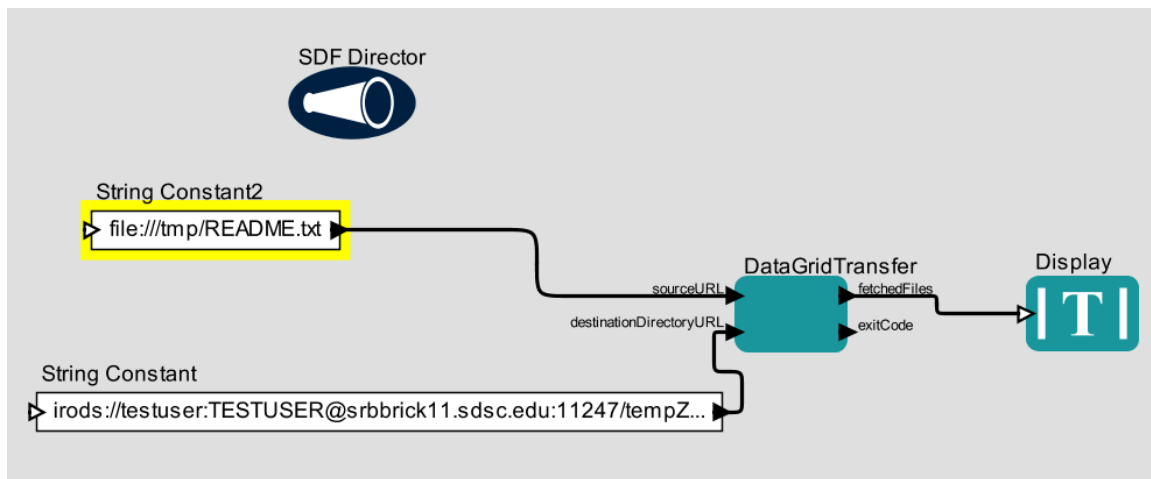

Figure 7.17: Using a *DataGridFileTransfer* actor to transfer files between different file system.

7.2 Remote Service Execution

Kepler has several actors that can invoke different types of services for use in workflows—from Web Services, to REST services, to SoapLab services. In this section, we will look at a few examples of various remote services and how they are invoked from a workflow.

7.2.1 Using Web Services

The *WebService* actor executes a Web service-- a computer program that runs on a remote host and communicates using a standardized protocol. The actor invokes the Web service and broadcasts the response through its output ports.

³¹ <https://www.irods.org/index.php/Jargon>

Each Web service is described by a Web Service Description Language ([WSDL](#)) file. WSDL is a format for describing network services--from simple eBay watcher services to complex distributed applications. The WSDL file defines the methods that the service can execute, as well as the type of data the service requires as input. Public WSDL files are typically available on the Web site of the organization that publishes the service. Check the WSDL description (you can open the WSDL URL in a browser to view it) to see if the service uses complex types (you can recognize complex types by the `<complexType name=xx>` tag used to declare them in the WSDL file). If the service uses complex types, you must use Kepler's *WSWithComplexTypes* actor; otherwise, use the *WebService* actor.

The *WebService* actor accepts the URL of a WSDL file and the name of an operation defined by that file (such as "getXMLEntry"). Available operations will automatically populate a drop-down menu for `methodName` parameter once the URL of a WSDL file has been specified and committed in the `wSDLUrl` parameter and the parameters.

(Figure 7.18).

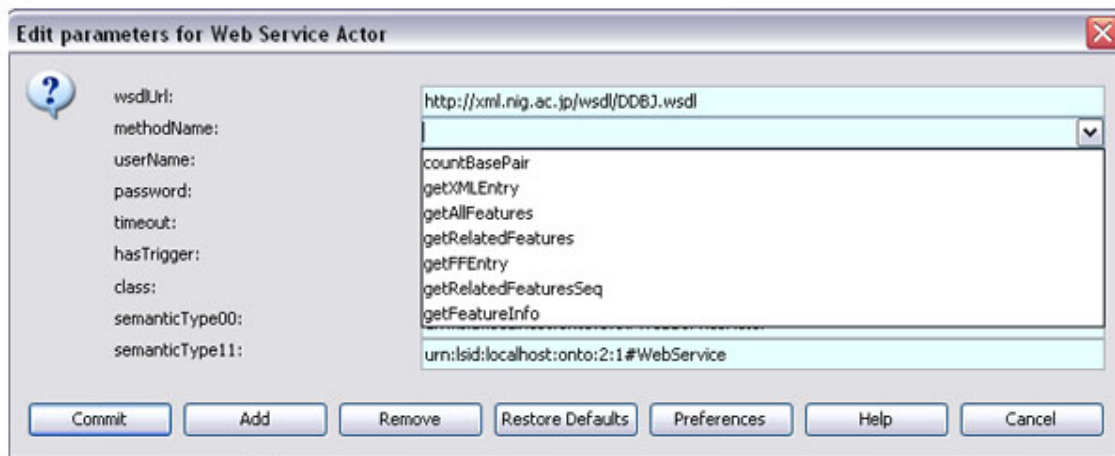

Figure 7.18: The parameters of the *Web Service* actor. Method names will automatically populate the drop-down menu once a `wSDLUrl` has been committed.

Once the user has selected and committed a WSDL and operation, the actor automatically configures itself to perform that operation by creating the necessary input and output ports.

The Web Services and Data Transformation workflow (found in the `$kepler/demos/getting-started` directory) uses the *WebService* actor to access a genomics database and return a genetic sequence from it, which is queried using a remote genomics data service. The name of the returned genetic sequence (i.e., the gene accession number) is passed to the *WebService* actor by a *StringConstant* actor named "Gene Accession Number" (Figure 7.19).

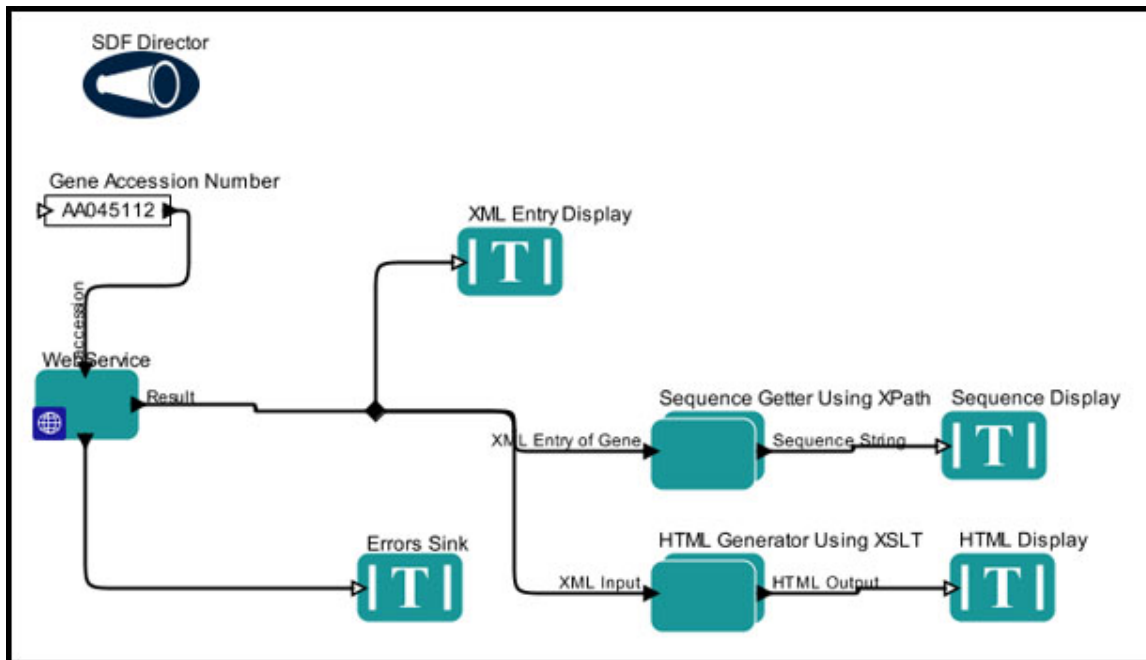

Figure 7.19: Using the *Web Service* actor to access a service and return a genetic sequence.

The *Web Service* actor outputs the gene sequence obtained from the remote server so that it can be displayed in multiple formats using three different textual *Display* actors: one for XML (the format in which the results are returned by default), one for a sequence of elements extracted from the XML, and one for an HTML document that can be displayed on a website. A Relation is used to “branch” the data output by the *Web Service* actor so that it can be shared by all of the necessary components.

The workflow uses two composite actors: *Sequence Getter Using XPath* and *HTML Generator Using XSLT* to process the returned XML data and convert it into a sequence of elements and an HTML file, respectively. These actors have been created for use with this workflow using existing Kepler actors. *Sequence Getter Using XPath* and *HTML Generator Using XSLT* do not appear in the Components tab. To see the “insides” of the composite actors, right-click the actor icon on the Workflow canvas and select Open Actor from the menu.

The resulting workflow and output are shown below (*Figure 7.20*).

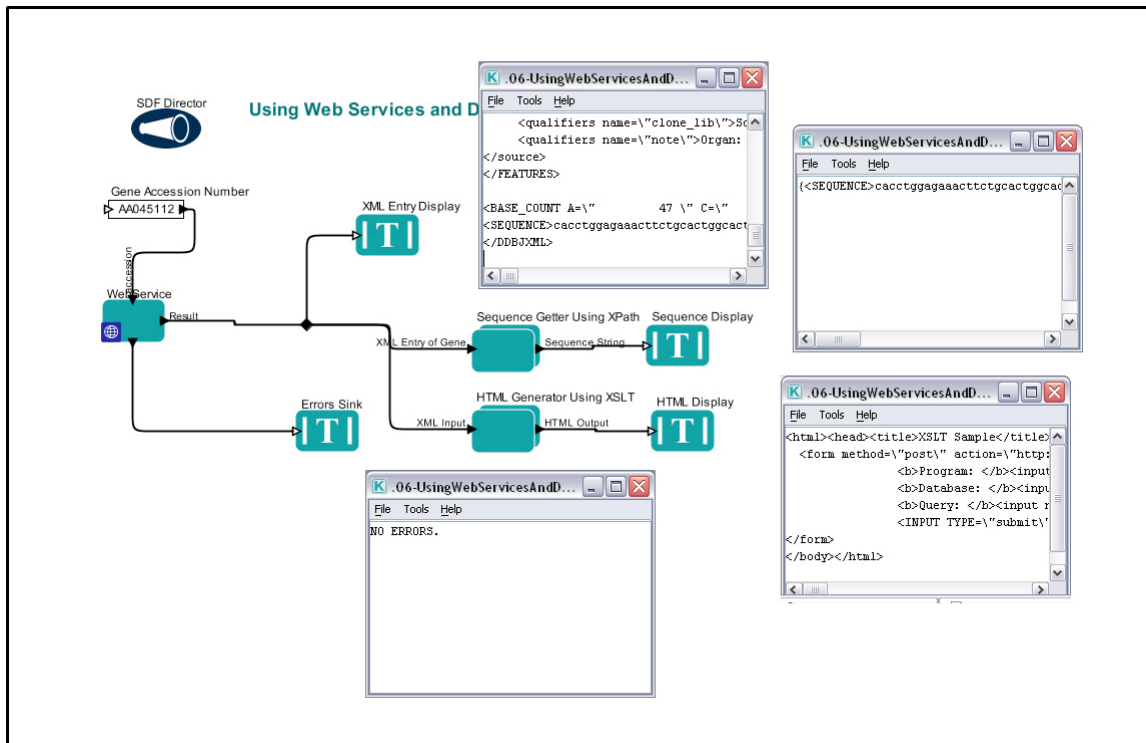

Figure 7.20: The Web Services workflow and its output.

The *WSWithComplexTypes* actor is similar to the *WebServices* actor, only it has several additional parameters: *inputMechanism* and *outputMechanism*, and, as we mentioned earlier, this actor should be used when the WSDL definition contains complex types. The *WSWithComplexTypes* actor automatically specializes its ports to reflect the input and output parameters of the Web service operation. For simple Web service types, e.g., string, int, double, etc., the ports are set to the matching Kepler types. For complex Web service types, the ports are set to XMLTOKEN. When the actor fires, it reads each input port, invokes the Web service operation with the input data, and outputs the response to the output ports.

The workflow in *Figure 7.21* uses the *WSWithComplexTypes* actor to return an array of organisms that are supported by ProThesaurus ("Protein Thesaurus", which implements a Biological Name and Mark-up Service for protein names and identifiers³²) Web service.

³² <http://services.bio.ifi.lmu.de:1046/prothesaurus/>

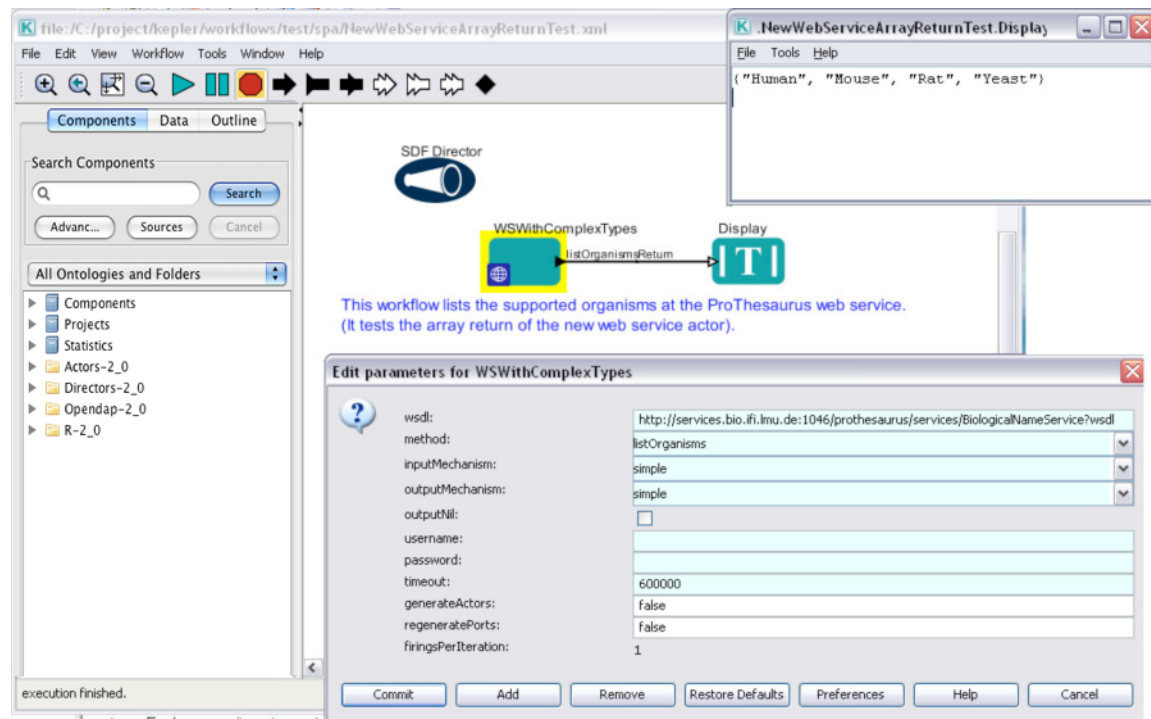

Figure 7.21: Using the *WSWithComplexTypes* actor to return supported organisms at the ProThesaurus Web service.

The URL of the WSDL defining the service is specified in the actor's `wsdl` parameter, and a method is selected (in this case, `listOrganisms`) from the drop-down menu that is populated when the Web service WSDL is committed. In addition, the `inputMechanism` and `outputMechanism` parameters are set to `simple`, the default. When these parameters are set to `simple`, the actor will behave as previously described, setting simple-types to their Kepler type equivalent, and complex-types to XMLTOKEN in the workflow.

Set the `inputMechanism` and `outputMechanism` parameters to `composite` to automatically create a composite actor that contains the *XMLAssembler* or *XMLDisassembler* actors needed to build any required complex Web service type (Figure 7.22). The *WSWithComplexTypes* >parameters actor in Figure 7.18 was automatically created and connected to the *WSWithComplexTypes* actor; this composite actor will accept and combine all the simple input types (e.g., strings representing the method, organism, etc) into the XML format required by the Web service. Changing the `inputMechanism` parameter back to `simple` deletes the connected composite actors. (If you have made changes to the composite actors and don't want them lost, disconnect them from *WSWithComplexTypes* before changing the mechanism to `simple`).

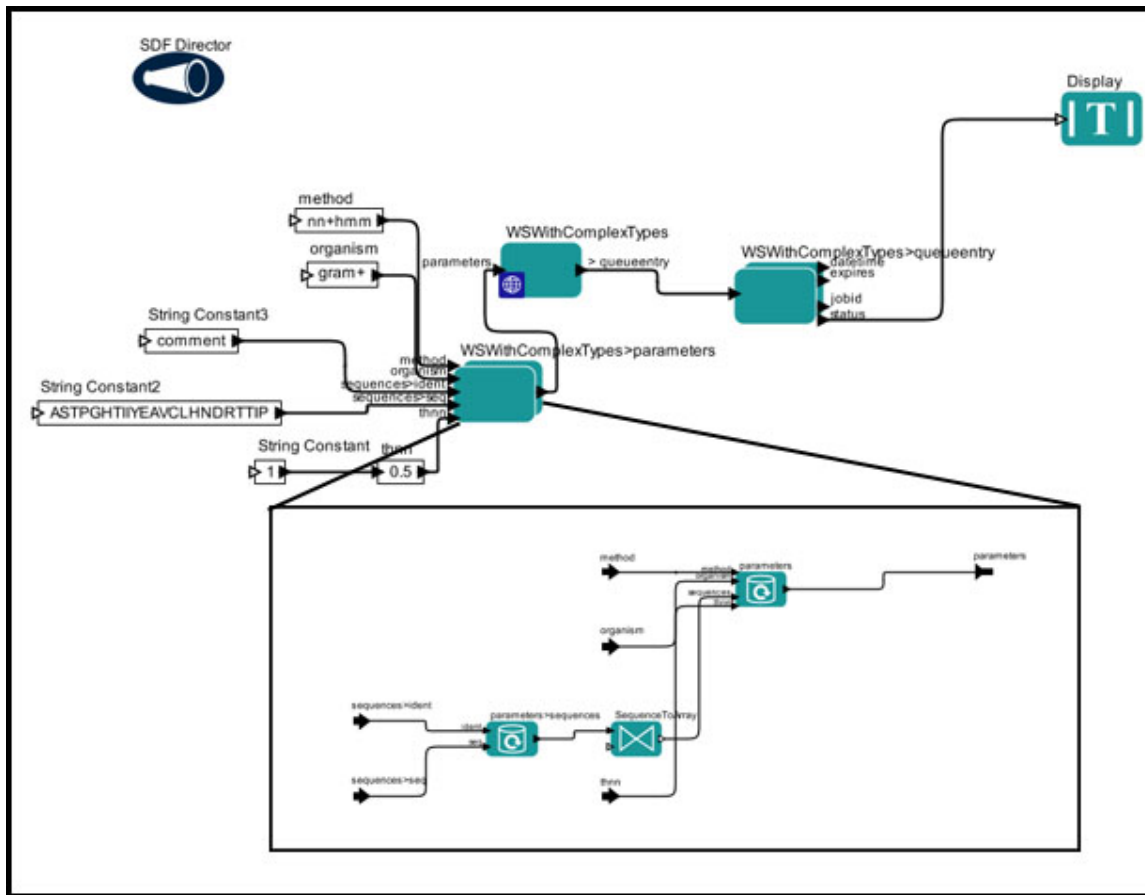

Figure 7.22: Set the `inputMechanism` and `outputMechanism` parameters to composite to automatically create a composite actor that contains the `XMLAssembler` or `XMLDisassembler` actors needed to build any required complex Web service type.

7.2.2 Using REST Services

A RESTful web service (also called a RESTful web API) is a simple web service implemented using HTTP and the principles of REST³³. The `RESTService` actor executes a REST service. The actor invokes the REST service and broadcasts the response through its output port.

The workflow in *Figure 7.23* calls a REST service at the Amazon web site, and the configuration information of the actor is shown in *Figure 7.24*. To The actor will the REST service: <http://developer.amazonwebservices.com/connect/entry.jspa>. To invoke the service, users should know from service provider that: 1) service Url; 2) it accept 'Get' or 'Post' invocation, and 3) the parameters for the service (externalID and ref are two parameters in the example). Since the service offers 'Get' method, so the `methodType` parameters in the *Figure 7.23* is set as 'Get'. The workflow passes two parameters name/value pairs and they are separated by ',' (without quotes) delimiter that

³³ Wikipedia, http://en.wikipedia.org/wiki/Representational_State_Transfer#RESTful_web_services

is also defined as a parameter in the dialog box. Its value could be changed to something else especially when user has a parameter value that contains ‘,’ (without quotes).

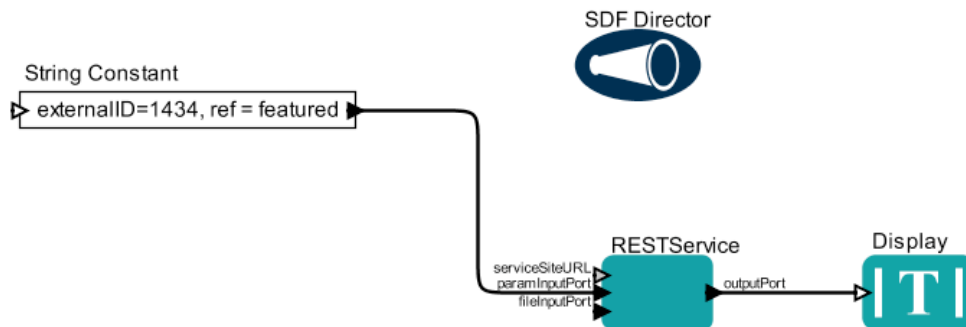

Figure 7.23: Using RESTService actor to call a REST service in Amazon web site.

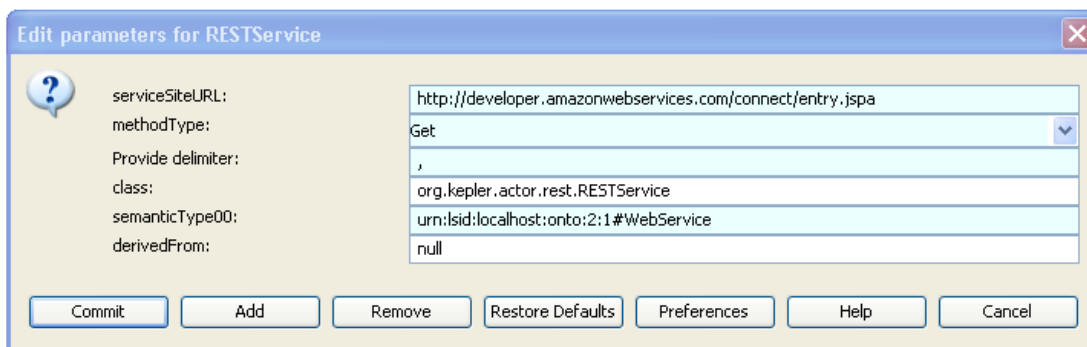

Figure 7.24: The parameters of the *RESTService* actor.

7.2.2 Using Soaplab Services

Soaplab is a set of Web Services providing programmatic access to command-line tools available on remote computers. Because such tools usually analyze data, Soaplab is often referred to as an Analysis (Web) Service. Soaplab services are defined by an API that is the same for all analysis tools, regardless of the operating system where they run, the manner in which they consume and produce data (e.g., from/to files or from/to standard streams), and the precise syntax of the underlying command line tools.³⁴

Kepler's Soaplab actors can access any derived Web service that is described by Web Service Description Language (WSDL) and is registered with the European Bioinformatics Institute (EBI). For a complete list of EBI-registered WSDLs, see <http://www.ebi.ac.uk/soaplab/services>.

³⁴ Senger, Martin, Peter Rice, and Tom Oinn. Soaplab –a unified Sesame door to analysis tools. Proc UK e-Science programme All Hands Conference, 2003 - nesc.ac.uk

The workflow in *Figure 7.25* uses a Soaplab service called `segret` to return a protein sequence from the [EMBL Nucleotide Sequence Database](#), a nucleotide sequence resource.

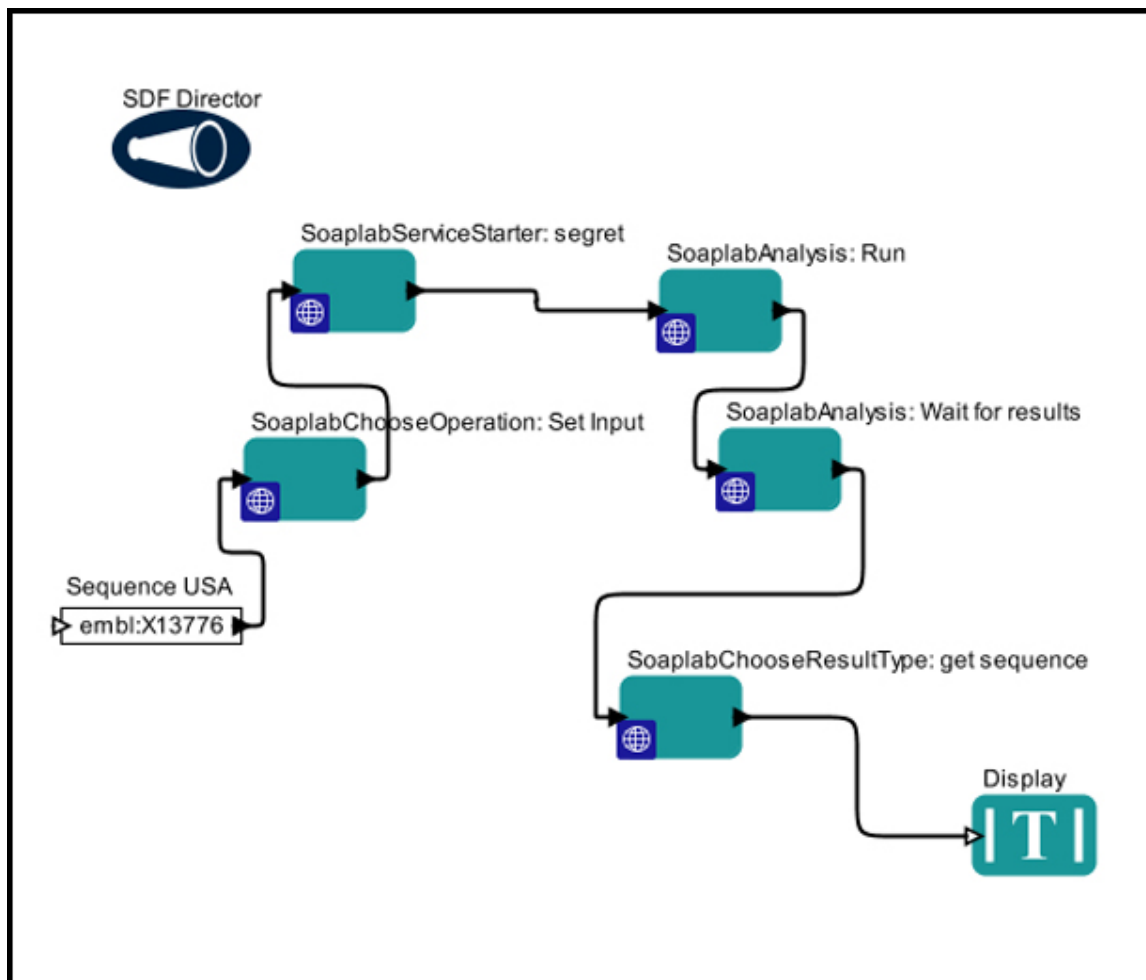

Figure 7.25: Using Soaplab actors to lookup a protein sequence from the EMBL Nucleotide Sequence Database.

A *StringConstant* actor (called "Sequence USA") is used to pass the input—in this example, a Uniform Sequence Address (USA)—to the Soaplab service. USAs are a very flexible way of specifying one or more sequences from a variety of sources (files, databases, etc). The format used in the workflow consists of a database name followed by an accession number, which is a unique identifier given to a biological polymer sequence (DNA, protein) when it is submitted to a sequence database³⁵. For more information about USAs, please see <http://emboss.sourceforge.net/docs/themes/UniformSequenceAddress.html#usa>.

³⁵ Wikipedia, http://en.wikipedia.org/wiki/Accession_number

The *SoaplabChooseOperation* actor receives the USA and "prepares" the input for the Soaplab service. The actor requires the WSDL of the Soaplab service, which is specified via parameters (Figure 7.26)

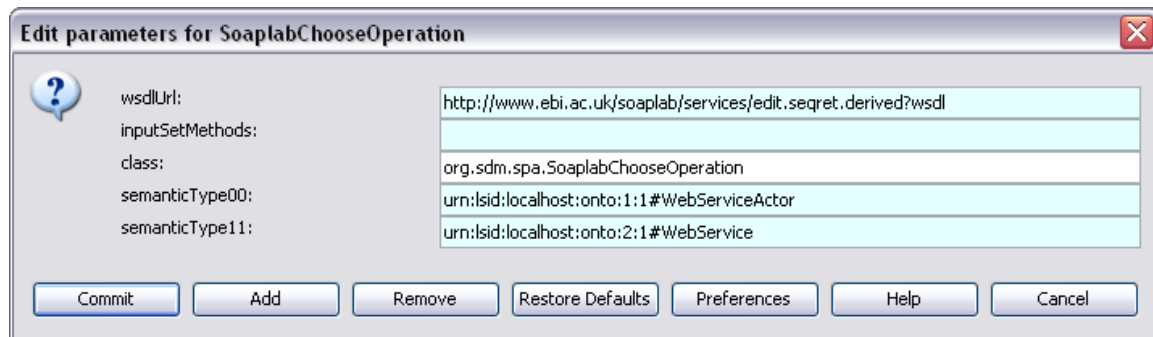

Figure 7.26: The parameters of the *SoaplabChooseOperation* actor.

Once a `wsdlUrl` has been specified and the setting has been committed, the *SoaplabChooseOperation* actor will automatically populate the `inputSetMethods` parameter with a drop-down menu of available "set methods", which are used to identify the input (Figure 7.27) so that the Soaplab service can recognize and use it.

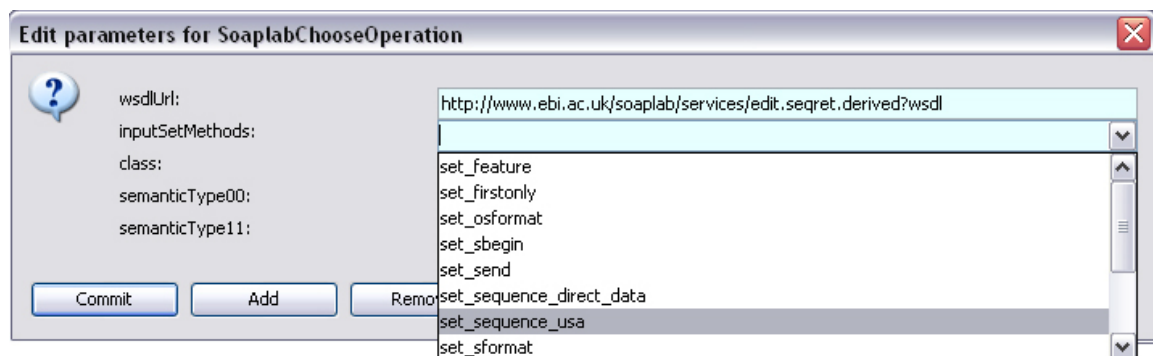

Figure 7.27: A drop-down menu of input "set methods" that is automatically generated by the *SoaplabChooseOperation* actor after a WSDL URL has been specified and committed.

The example workflow uses the `set_sequence_usa` set method to specify that the input is a USA. If the input were a fasta formatted sequence instead (an actual protein sequence described in a text-based format), use the `set_sequence_direct_data` menu item; other set methods describe additional types of input that the service accepts: an output sequence format (`set_osformat`) or the last position to use in the sequence (`set_send`), for example. For more information about the types of input that can be set and passed to the seqret service, see

<http://emboss.sourceforge.net/apps/release/4.1/emboss/apps/seqret.html>.

The WSDL of the Soaplab service must also be specified in the parameters of the *SoaplabServiceStarter* actor, which starts the Soaplab service. The actor starts the service by creating an empty job used to execute the process before the workflow is even run.

The two *SoaplabAnalysis* actors perform standard Soaplab operations: `run` and `waitFor`. Non-standard operations can be specified and performed as well, provided they are defined in the service's WSDL file. See the documentation for individual Soaplab services for more information about defined operations.

The *SoaplabChooseResultType* actor "grabs" the desired service output using "get methods". The actor generates a list of relevant methods once the WSDL of the service has been specified and committed (Figure 7.28). In this case, the `get_outseq` method is used to return the protein sequence. By default, sequences are returned in fasta format.

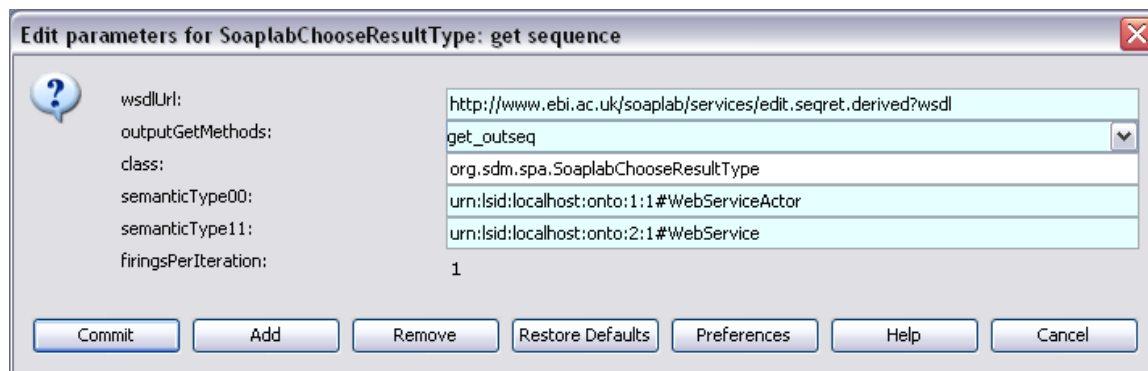

Figure 7.28: Parameters of the *SoaplabChooseResultType* actor. `outputGetMethods` are used to "grab" the desired results output by the service.

If the service executes successfully, the retrieved sequence is displayed by the *Display* actor (Figure 7.29).

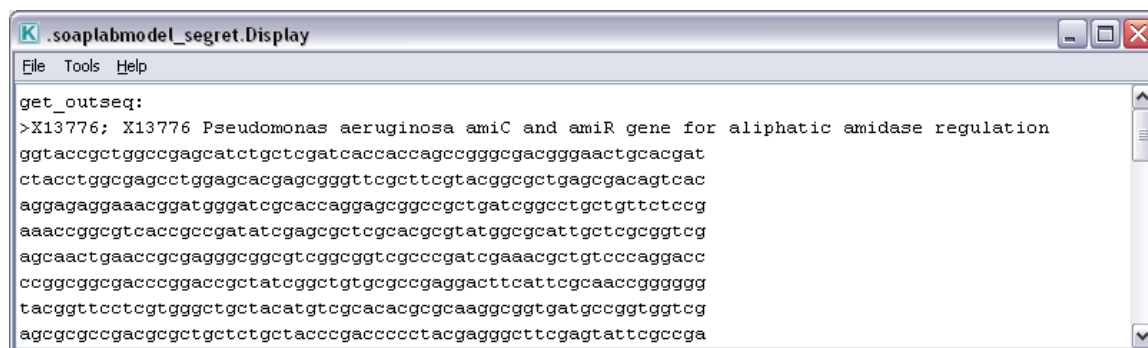

Figure 7.29: The protein sequence output by the Soaplab workflow.

7.2.3 Using Opal Services

Opal³⁶ is a toolkit for wrapping scientific applications as Web services, providing features such as scheduling, standards-based Grid security and data management in an easy-to-use and configurable manner. Opal toolkit is provided by National Biomedical Computation Resource, University of California, San Diego.

³⁶ <http://www.nbcr.net/software/opal/>

Kepler's Opal Client actors can access any Web services that are generated by Opal toolkit. For the list of Web services deployed at opal project, see <http://ws.nbc.net/opal2/services>.

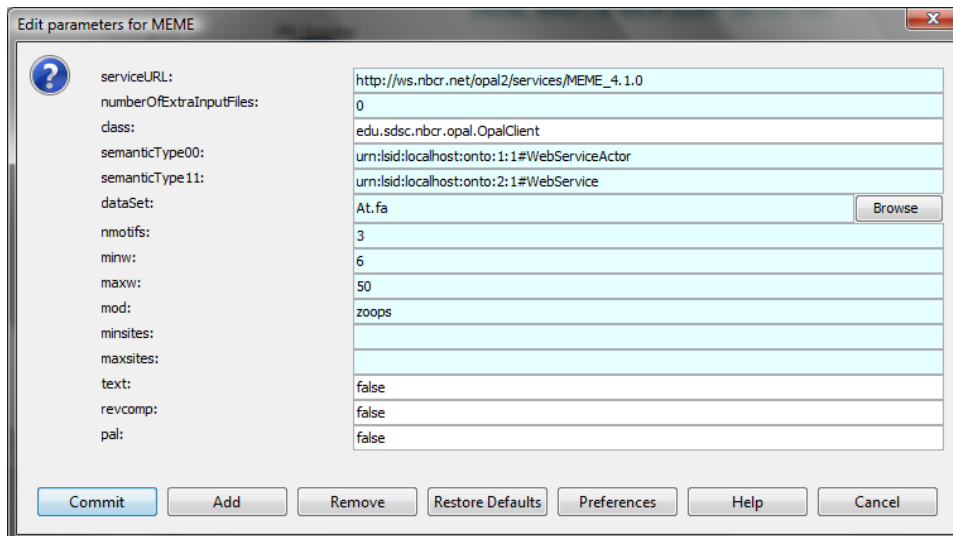

Figure 7.30: An Opal Client actor where other parameters are dependent on serviceURL parameter value.

An Opal Client actor is shown at *Figure 7.30*, which has service URL and other parameters to run the service. Other parameters are dependent on serviceURL parameter value. So users need to firstly fill in the value of serviceURL parameter, and then click *Commit* button. After this step, users can double-click the actor again to get other parameter options.

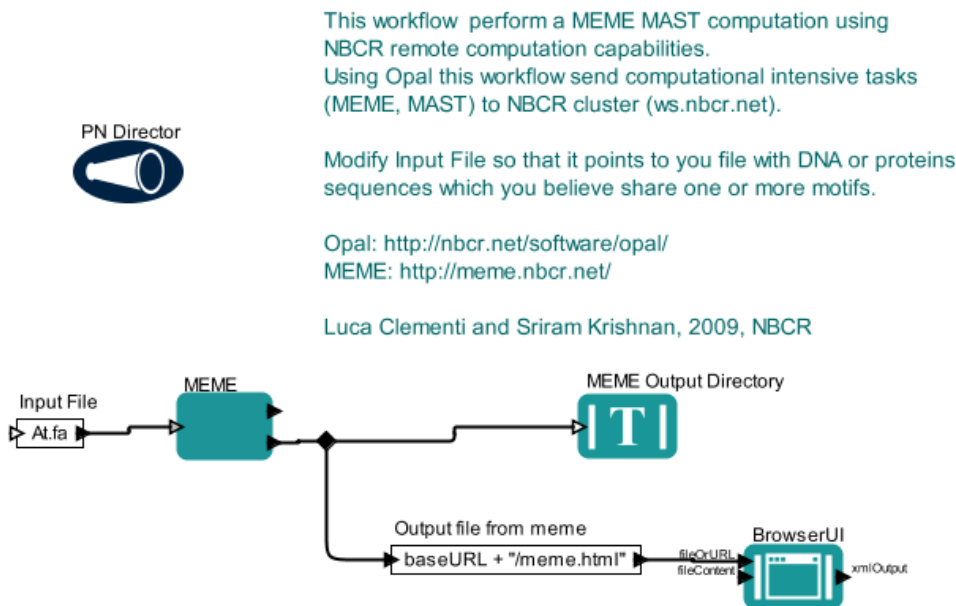

Figure 7.31: A sample workflow using configured Opal Client Actor, called MEME, to access MEME Web service generated by Opal toolkit.

A sample workflow using the above configured Opal Client Actor, called MEME, to access MEME Web service generated by Opal toolkit is demonstrated at *Figure 7.31*. The file connected to the input of MEME actor, called At.fa, will be automatically transferred to the server side and get executed. The base URL containing the working directory of the running jobs MEME Web service is obtained from the baseUrl output port of MEME for downstream processing.

7.3 Job Submission

Job submission is a common and efficient way to utilize distributed computing resources, such as Cluster, Grid. Kepler has two set of actors that can submit jobs to two typical distributed resources: Cluster and Grid. Each set has some actors which can be used for different job operations: create, submit, status check. In this section, we will look at a few examples of these actors and how they are combined from a workflow to realize the whole lifecycle of job submission.

7.3.1 Cluster Job Submission

A computer cluster is a group of linked computers, working together closely so that in many respects they form a single computer.

The Kepler component library contains several actors that can be used for different Cluster job operations: *JobCreator*, *JobFileFetcher*, *JobGetDirectory*, *JobGetRealJobID*, *JobManager*, *JobRemover*, *JobStatus*, *JobSubmitter*. The current supported job scheduler includes Condor, Fork, LoadLeveler, NCCS, PBS and SGE.

As shown in *Figure 7.32 – 7.35*, a common logic for cluster job operations include three main steps: select job manager according to its type by the *JobManager* actor, submit job to a cluster by the *JobCreator* and *JobSubmitter* actor, check cluster status by the *JobStatus* actor within a loop.

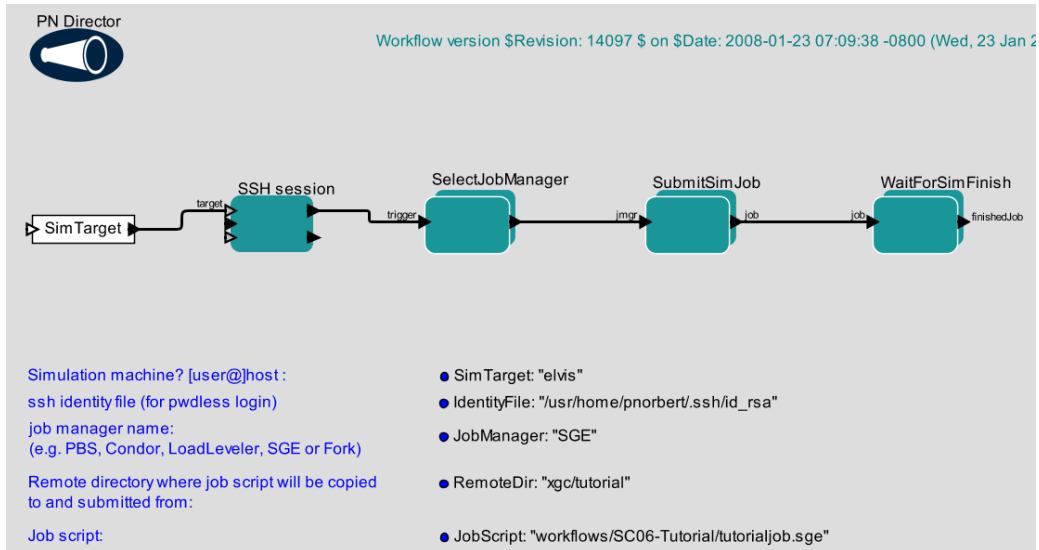

Figure 7.32: An example workflow for cluster job operations, whose sub-workflow in SelectJobManager, SubmitSimJob and WaitForSimFinish are shown in Figure 7.33, 7.34 and 7.35 respectively.

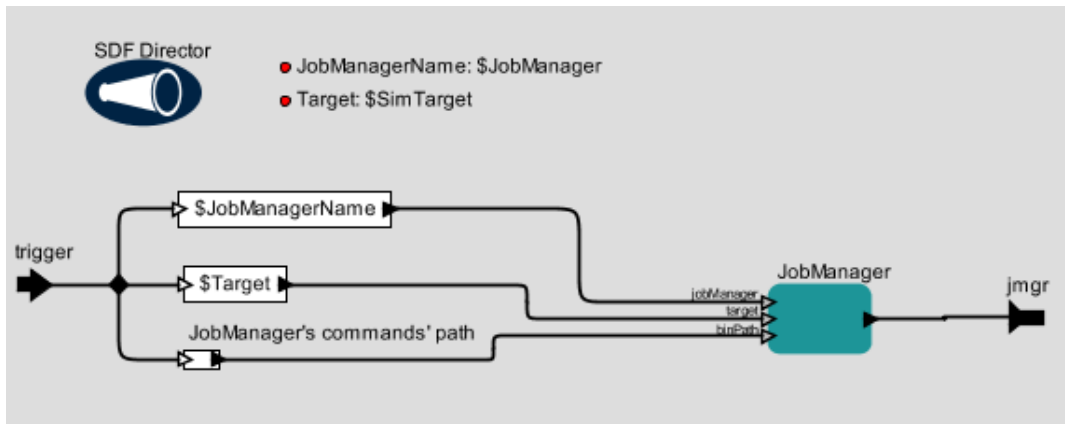

Figure 7.33: The content of SelectJobManager composite actor in Figure 7.32.

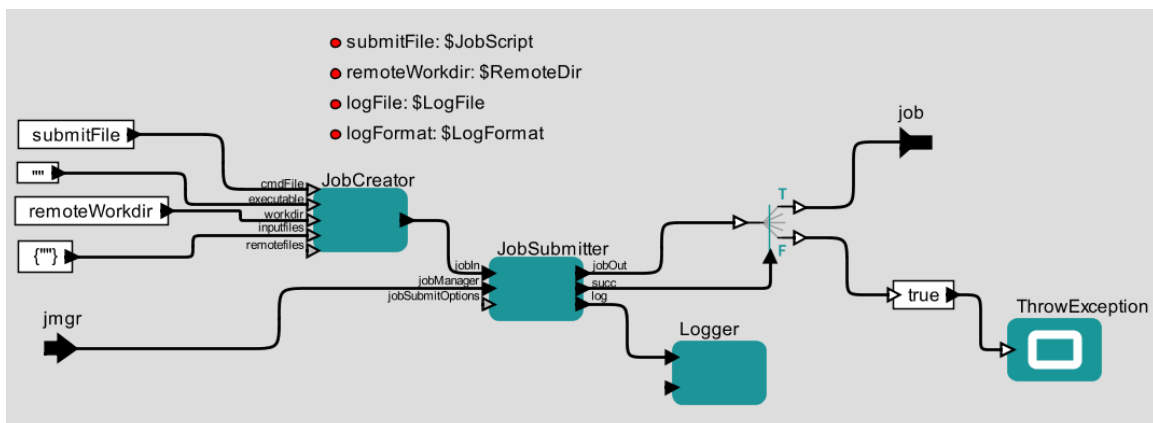

Figure 7.34: The content of SubmitSimJob composite actor in Figure 7.32.

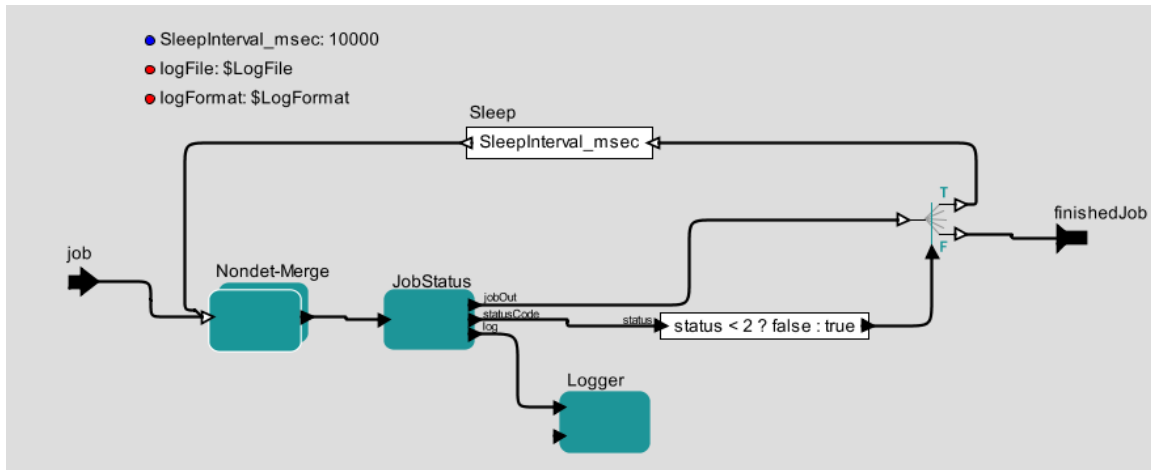

Figure 7.35: The content of WaitForSimFinish composite actor in Figure 7.32.

Besides the above set of actors, another actor called *GenericJobLauncher* is a generic actor that can create, submit and manage a job on a remote machine accessible through SSH. The user may choose to wait till the job has attained a specific status in the queue - for example till it is 'Running', 'Complete', 'Not in Queue' and etc. A sample workflow is shown in Figure 7.36. If the 'Wait Until Status' parameter of *GenericJobLauncher* actor is set as 'Not in Queue', the workflow will keep running until the job is done at the target cluster.

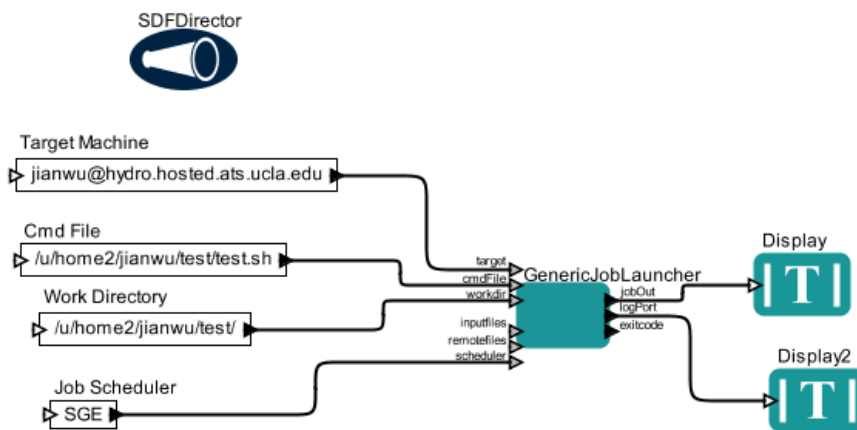

Figure 7.36: An example workflow for cluster job submission using *GenericJobLauncher* actor.

7.3.2 Grid Job Submission

With Grid infrastructure, users are able to locate, submit, monitor and cancel remote jobs on Grid-based compute resources. A Grid job is an executable or command that runs on a (typically remote) Grid resource. Currently, Kepler mainly supports job submission to Grid resources built by Globus Toolkit³⁷. To support job submission to Grid resources

³⁷ <http://www.globus.org/toolkit/>

built by other Grid toolkits, such as Campus Grid Toolkit³⁸ and gLite³⁹, the corresponding actors need to be implemented.

To initiate, monitor, manage, schedule, and/or coordinate remote computations, Globus toolkits, supports the Grid Resource Allocation and Management (GRAM) interface. Usually two different GRAM implementations, namely Pre-WS GRAM and WS GRAM, are provided by the different versions Globus Toolkit, e.g. GT4⁴⁰.

Kepler provides two sets of actors to support these two implementations respectively. We will first introduce how to get proxy certificates, which is the security prerequisite to invoke Globus actors. Then the two sets of actors to submit Globus jobs using Pre-WS GRAM and WS GRAM will be introduced.

7.3.2.1 Kepler Globus Actors for Proxy Certificate

To use Globus services, end users need two X.509 certificates. The first one is user certificate, which is issued by a certification authority (CA) and is used to identify users. This certificate will typically be valid for a year or more and will be stored in a file in the individual's home directory. The second certificate is proxy-certificate, which is to support the temporary delegation of the user's privileges to user grid services. Proxy certificates typically have a much shorter lifetime than end-user certificates (usually 12 hours). Several ways are provided by Globus Toolkit, which is listed at <http://globus.org/toolkit/docs/latest-stable/security/>.

The *GlobusProxy* actor uses Globus certificate and key file to create a proxy certificate. These files are issued by a trusted Grid authority, called a Certificate Authority (CA) and are stored on your local system (usually as "usercert.pem" and "userkey.pem"). The *GlobusProxy* actor references these credentials with its parameters (*Figure 7.37*) and uses them to create a proxy certificate, which is used by downstream Globus actors.

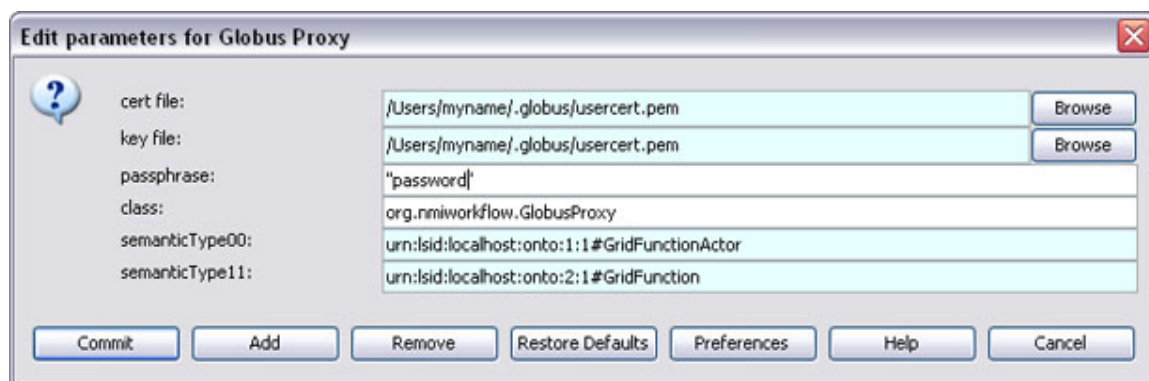

Figure 7.37: Setting the parameters of the GlobusProxy actor.

³⁸ <http://www.omii.ac.uk/wiki/CGT>

³⁹ <http://glite.web.cern.ch/glite/>

⁴⁰ <http://www.globus.org/toolkit/docs/4.0/execution/>

The *MyProxy* actor is to create a Globus proxy certificate by ‘MyProxy user account’ or ‘MyProxy X509 Credential file’ way. For ‘MyProxy user account’ way, users need to specify host info (URL and port) and user info (username and password). For MyProxy Credential way, which is shown in *Figure 7.38*, users need to specify the file path, is /tmp/x509up_u<uid> typically. More information about MyProxy can be found at <http://grid.ncsa.uiuc.edu/myproxy/> and <http://globus.org/toolkit/docs/latest-stable/security/myproxy/>.

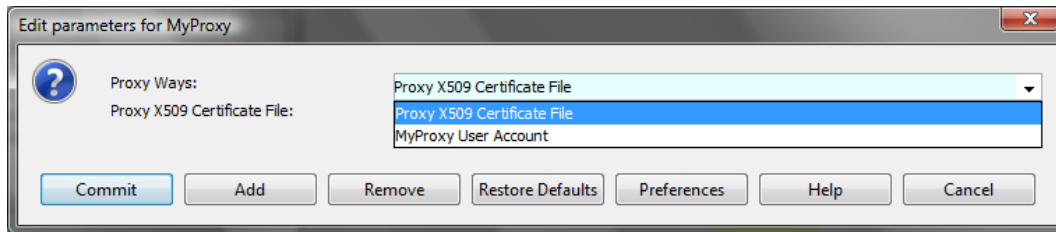

Figure 7.38: Setting the parameters of the MyProxy actor.

7.3.2.2 Kepler Globus Actors for Pre-WS GRAM

Pre-WS GRAM is the GRAM implementation first introduced in GT2. In Pre-WS GRAM, the jobs to be submitted can be described using the Resource Specification Language (RSL), a common interchange language to describe resources. For more information about using and creating RSL strings, please see the Globus online documentation, http://www.globus.org/toolkit/docs/2.4/gram/rsl_spec1.html, or <http://programaticus.com/an/globus/RSL.html>.

The *GlobusJob* actor accepts the certificate generated by the *GlobusProxy* actor via an input port. To use the actor to execute a job on a remote Globus host, specify the name of a Globus server (e.g., "griddle.sdsc.edu") and a Resource Specification Language (RSL) string, which defines the commands to perform. A full RSL string must be specified (*Figure 7.39*).

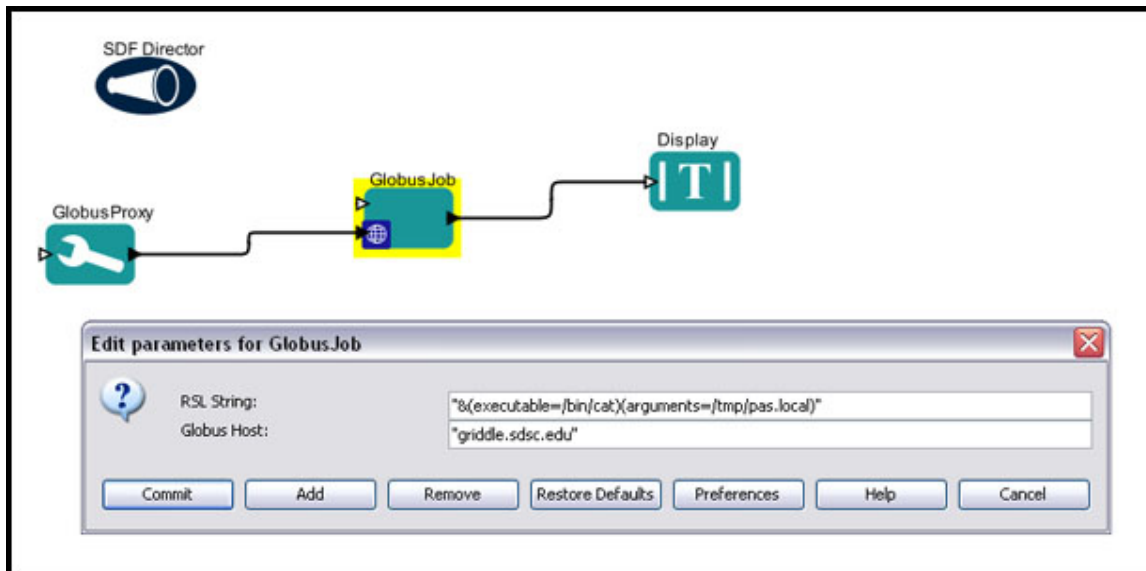

Figure 7.39: Using the *GlobusJob* actor to execute a command on a remote Globus server by Pre-WS GRAM way.

The workflow in *Figure 7.39* uses actors to connect to a Globus host named `griddle.sdsc.edu`. The *GlobusJob* actor passes a specified RSL String `"&(executable=/bin/cat)(arguments=/tmp/pas.local)"` to the server, where it is executed. In the above example, the host is instructed to print the file `pas.local` from the `tmp` directory. The *GlobusJob* actor then outputs the printed file as a string.

The same workflow functionality could be achieved without using an RSL string by using the *ParameterizedGlobusJob* actor instead of the *GlobusJob* actor. Instead of passing an RSL string to a Globus host, the *ParameterizedGlobusJob* actor passes a command (specified as an executable path) and command arguments (input via a port). The workflow in *Figure 7.40* has the same output as the workflow in *Figure 7.39*.

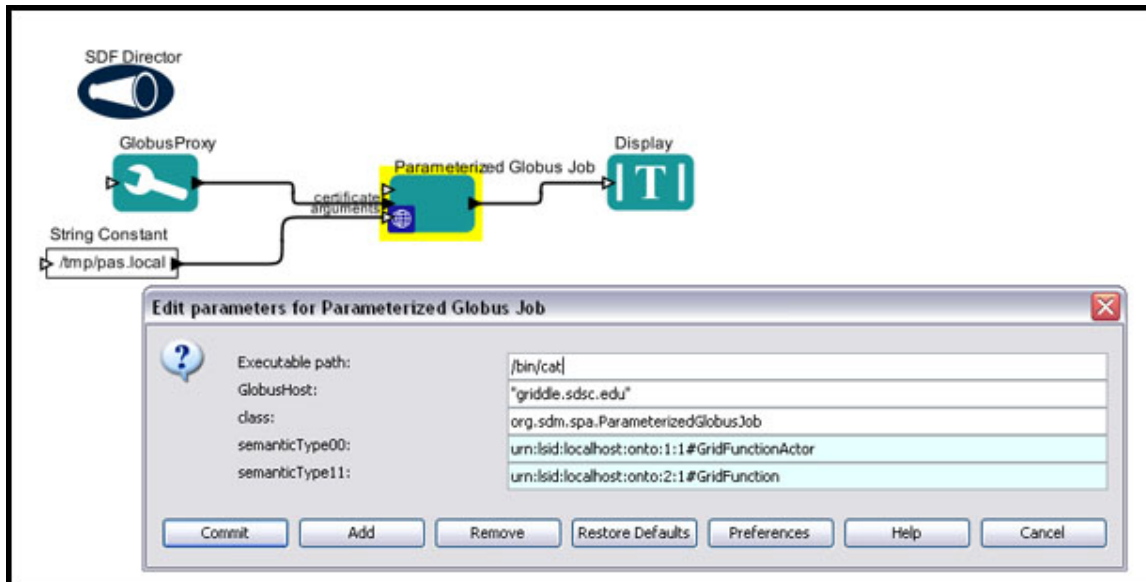

Figure 7.40: Using the *ParameterizedGlobusJob* actor.

The name of the Globus host and the remote executable (`/bin/cat`) is specified in the *ParameterizedGlobusJob* actor's parameters. Arguments, in this case the path to the file to open and output (`/tmp/pas.local`), is passed via the actor's input port.

7.3.2.2 Kepler Globus Actors for WS GRAM

WS GRAM builds on Web services technologies and is the recommended system for most users due to its superior scalability and its support for WS-Security mechanisms. In WS GRAM, the jobs to be submitted can be described by the Job Description Schema, an xml language to describe resources. For more information about using and creating the Job Description Schema, please see the Globus online documentation, http://www.globus.org/toolkit/docs/4.2/4.2.1/execution/gram4/schemas/gram_job_description.html.

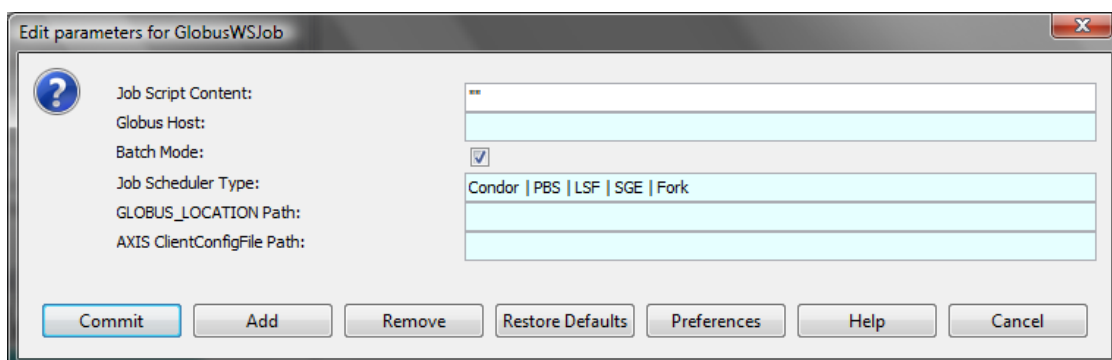

Figure 7.41: Setting the parameters of the *GlobusWSJob* actor.

The *GlobusWSJob* actor accepts the certificate generated by the *MyProxy* actor via an input port. To use the actor to execute a job on a remote Globus host, specify the name of

a Globus server (e.g., "griddle.sdsc.edu") and a Job Description string, which can be gotten from a Job Description file or defined by *GlobusJobDescriptionGenerator* actor. The parameter configuration dialogue is shown in *Figure 7.41*, where users can specify whether the job will be executed in batch mode, job scheduler type of the Globus Host (which is Fork, SGE, PBS, LSF or Condor), the GLOBUS_LOCATION and AXIS ClientConfigFile Path of the client machine.

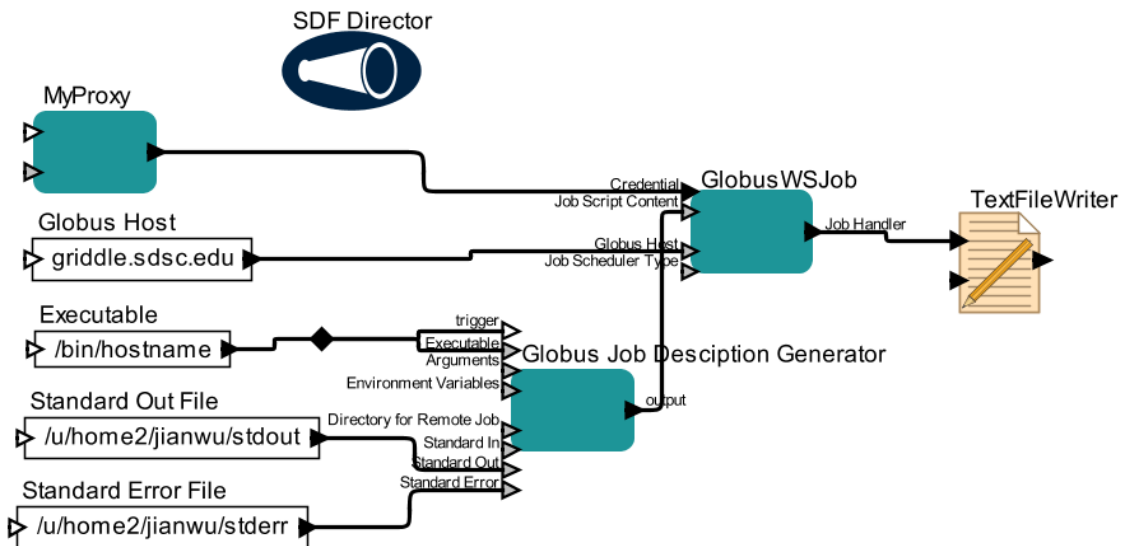

Figure 7.42: Using the *GlobusWSJob* actor to execute a command on a remote Globus server by WS GRAM way.

The workflow in *Figure 7.42* uses actors to connect to a Globus host named `griddle.sdsc.edu`. Using *GlobusJobDescriptionGenerator* actor, this workflow defines the executable, out file and error file information for the job to be submitted. The *GlobusWSJob* actor uses the defined job description and submits to the specified Globus host, where the job is executed. The output of the *GlobusWSJob* actor is the job handler of the submit job which can be used to check status or other operations.

The workflow in *Figure 7.43* uses *GlobusWSJobStatus* actor to check the current status of a job by its jobhandler. A typical jobhandler is like <https://griddle.sdsc.edu:8443/wsrp/services/ManagedExecutableJobService?7b431d30-62a7-11de-bf68-da862a69e457>. The string description of the status, which is "UnSubmitted", "Active", "Done", "Failed" or "Expired", can be gotten from the 'Job Status' output of the *GlobusWSJobStatus* actor. Using the logic similar in *Figure 7.32*, it is easy to construct a workflow which submit a job and monitor its execution until it is done or get exception by composing the above actors for Globus WS GRAM execution.

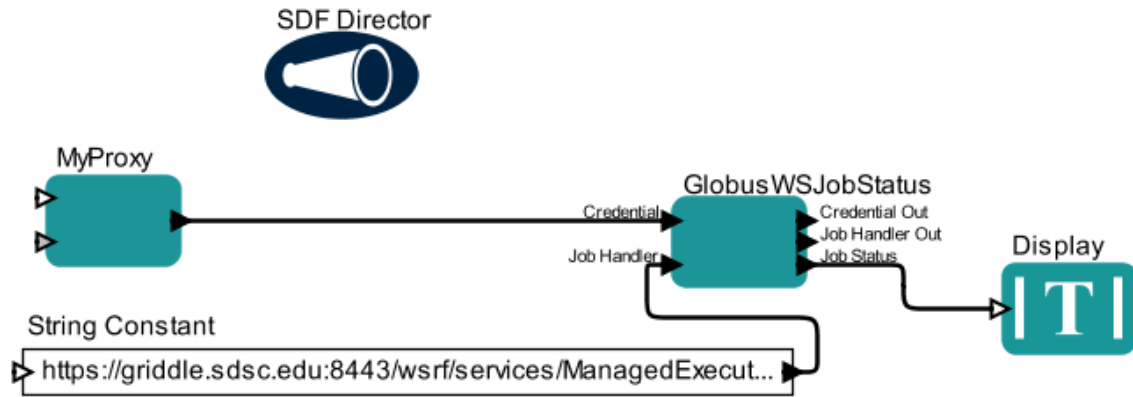

Figure 7.43: Using the *GlobusWSJobStatus* actor to get the status of a Globus job by its job handler.

8. Mathematical, Data Analysis, and Visualization Packages

The Kepler library contains a number of useful actors that interface with commonly used applications and integrate their functionality into workflows. Without ever leaving the Workflow canvas, workflow designers can access the powerful statistical and data processing environments of R and/or MATLAB, the image processing features of ImageJ, and the convenient expression language built into Kepler itself.

8.1 Expressions and the Expression Actor

The Kepler expression language provides a convenient infrastructure for specifying algebraic expressions textually and for evaluating them. In this section, we will look at several examples of how the expression language and the *Expression* actor are used—from specifying the values of parameters to performing calculations with the *Expression* actor. For a complete reference on the Expression language, please see the [Ptolemy user documentation](#).

Expressions can contain variables, constants—either a symbolic name such as PI or NaN or a literal (an integer, string, float, etc)—operators (+, -, *, etc), and functions (either built-in ones such as sin() and cos(), or user-defined functions). The following are examples of expressions:

1	An integer
PI/2	A symbolic constant divided by a literal
sin(PI/2)	A function performed on a symbolic constant divided by a literal
{1,2,4,5,6}	An array
"ImAString"	A string
CWD	The current working directory. CWD is a built-in string-valued constant

Expressions are often used as the values of parameters, port parameters, string parameters and inside the *Expression* actor, which evaluates a specified expression and outputs the value.

For more information about expressions and the expression language, please see the [Ptolemy documentation](#).

8.1.1 The Expressions Language

The Kepler Expression language, which provides a means of specifying and evaluating algebraic expression textually, is identical to the Ptolemy Expression language. The language can be used to represent constants and literals, variables, operators, arrays, matrices, records, methods and functions, and we'll look at examples of each in this section. The material in this section is based on the Ptolemy documentation. For additional information, please see [Chapter 3](#) of the Ptolemy User Manual.

To begin experimenting with expressions, select Tools > Expression Evaluator from the Toolbar. A command-shell styled window opens (*Figure 8.1*). Expressions will be evaluated on return. To scroll back to previous commands, click the up arrow (or Control-P). To scroll forward, click the down arrow (or Control-N).

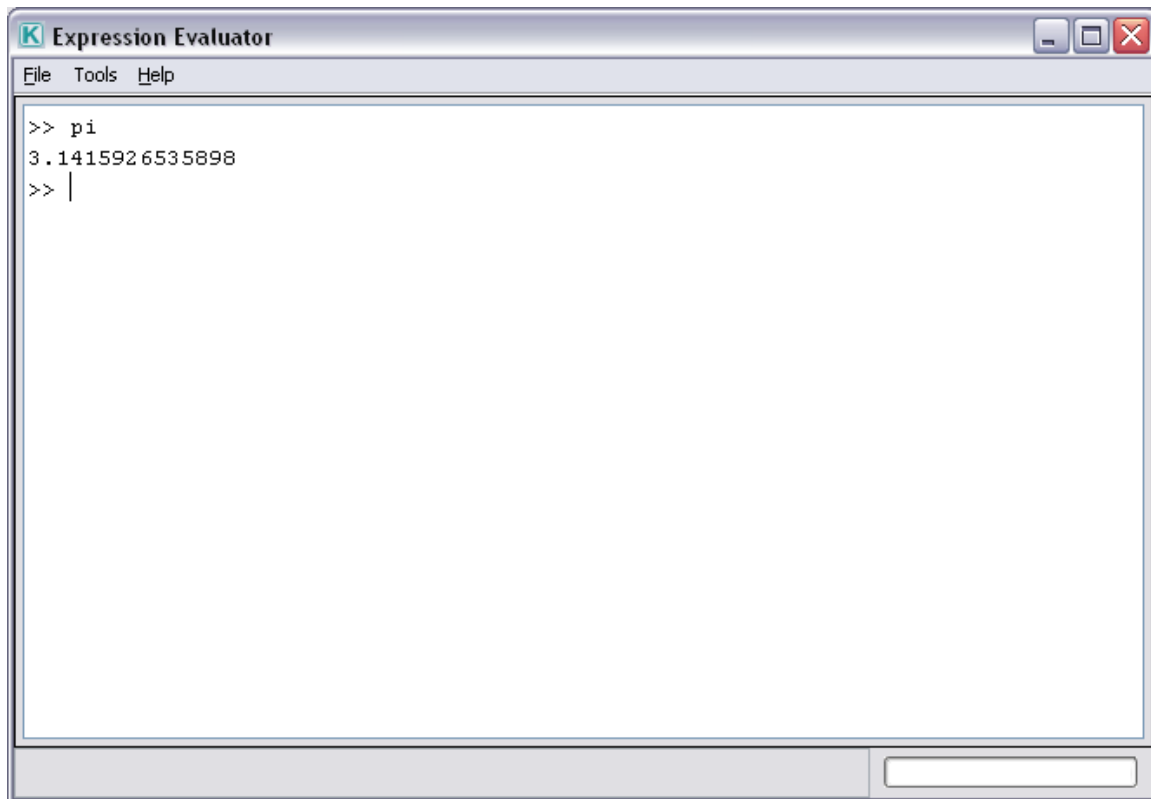

Figure 8.1: The Expression Evaluator. In this example, the system returns the value of the expression pi.

8.1.1.1 Constants and Literals

The simplest expression is a constant, either a literal (a number or string) or a symbolic name (e.g., PI). Please see *Table 8.1* for a list of supported symbolic names. Numerical constants can be integers (e.g., 1 or 73), doubles (e.g., 33.2 or 1.5), longs (e.g., 12L), unsigned bytes (e.g., 5ub), or complex numbers (e.g., 2+3i). Anything between double quotes is interpreted as a string ("hello" or "777"). In addition, Kepler has several globally defined string constants, noted in *Table 8.2*.

Numbers of type `int`, `long`, or `unsignedByte` can be specified in decimal, octal, or hexadecimal. Numbers with a leading “0” are octal numbers. Numbers with a leading “0x” are hexadecimal numbers. For example, “012” and “0xA” are both equal to the integer 10.

Symbolic Name	Meaning
<code>E</code> or <code>e</code>	$E = 2.718281828459$
<code>false</code>	False
<code>i</code> or <code>j</code>	Imaginary number with value equal to the square root of -1.
<code>Infinity</code>	Infinity. The result of dividing 1.0/0.0.
<code>MaxDouble</code>	Maximum double (i.e., 1.7976931348623E308). Numerical values with decimal points, such as “10.0” or “3.14159” are of type <code>double</code>
<code>MaxFloat</code>	$\text{MaxFloat} = 3.4028234663853E38$
<code>MaxInt</code>	Maximum integer (i.e., 2147483647)
<code>MaxLong</code>	Maximum long (i.e., 9223372036854775807L). Numerical values without decimal points followed by the character “l” (el) or “L” are of type <code>long</code> .
<code>MaxShort</code>	$\text{MaxShort} = 32767$
<code>MaxUnsignedByte</code>	Maximum unsigned byte (i.e., 255ub). Unsigned integers followed by “ub” or “UB” are of type <code>unsignedByte</code> (e.g., 5ub)
<code>MinDouble</code>	Minimum double (i.e., 4.9E-324). Numerical values with decimal points, such as “10.0” or “3.14159” are of type <code>double</code> .
<code>MinFloat</code>	$\text{MinFloat} = 1.4012984643248E-45$
<code>MinInt</code>	Minimum integer (i.e., -2147483648)
<code>MinLong</code>	Minimum long (i.e., -9223372036854775808L). Numerical values without decimal points followed by the character “l” (el) or “L” are of type <code>long</code> .
<code>MinShort</code>	$\text{MinShort} = -32768$
<code>MinUnsignedByte</code>	Minimum unsigned byte (i.e., 0ub). Unsigned integers followed by “ub” or “UB” are of type <code>unsignedByte</code> (e.g., 5ub)
<code>NaN</code>	“not a number,” e.g., the result of dividing 0.0/0.0
<code>NegativeInfinity</code>	Negative infinity.
<code>PI</code> or <code>pi</code>	$\text{PI} = 3.1415926535898$
<code>PositiveInfinity</code>	Infinity. The result of dividing 1.0/0.0.
<code>true</code>	True

Table 8.1: Supported symbolic constants and their meaning

To see the list of globally defined constants, open Kepler's Expression Evaluator and type `constants()` at the command prompt. Kepler will return a list of defined constants and their values (*Figure 8.2*)

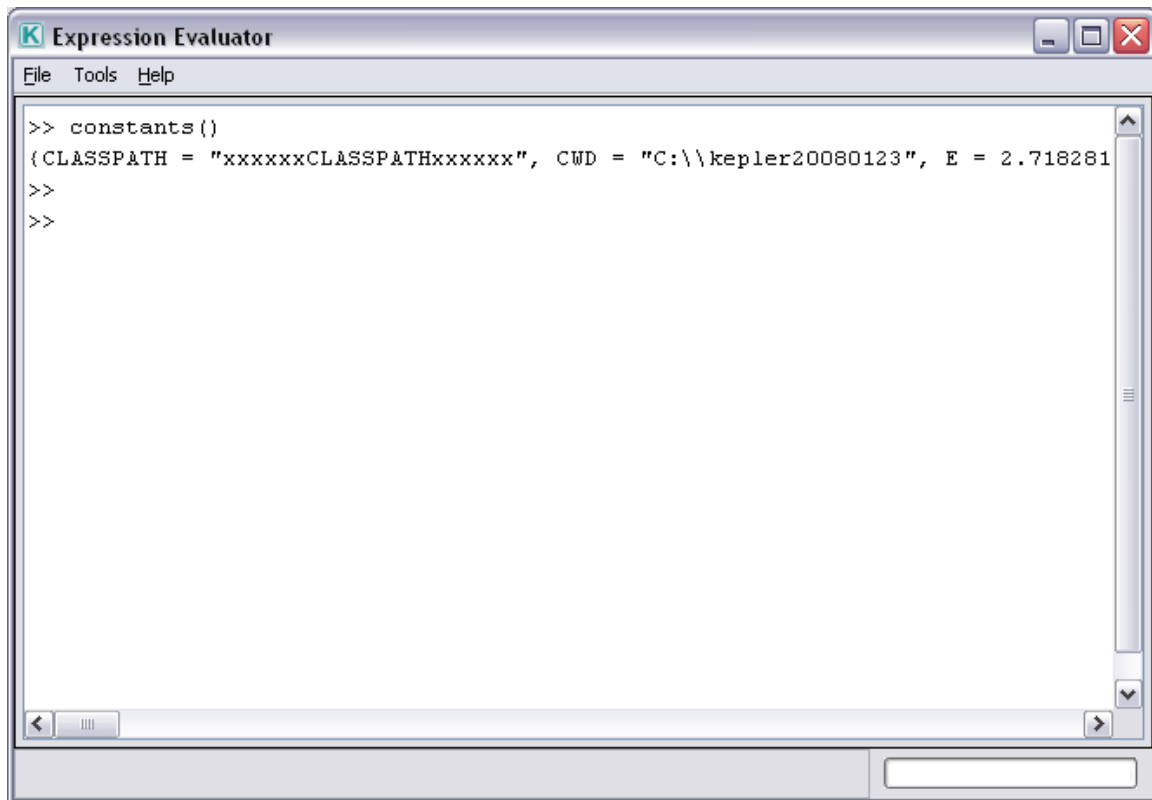

Figure 8.2: Use the `constants()` function to return globally defined constants and their values.

Predefined Strings	Meaning
PTII	The directory in which Ptolemy II is installed (e.g., <code>c:\tmp</code>)
HOME	The user home directory (e.g., <code>c:\Documents and Settings\you</code>)
CWD	The current working directory (e.g., <code>c:\ptII</code>)
TMPDIR	The temporary directory (e.g., <code>c:\Documents and Settings\you\Local Settings\Temp</code>)
KEPLER	The directory in which Kepler is installed (e.g., <code>c:\kepler</code>)

Table 8.2: Predefined String Values in Kepler

8.1.1.2 Variables

Expressions can contain variables—either built-in constants such as `PI` or assignments that have been made previously. For example, the following expression uses a variable named "x", which is multiplied by the value 2.

```
2*x
```

Kepler can only evaluate the above expression (or any expression that uses variables for that matter) if the variable is defined. Variables must be defined at the same level of hierarchy or above (if working with nested workflows). For example, in *Figure 8.3*, the variable `x` is defined as 4. Kepler can evaluate the expression `2*x` (i.e., 8) because it knows the value of `x`. Kepler cannot evaluate the expression `2*y`, however, as the `y` variable is not defined.

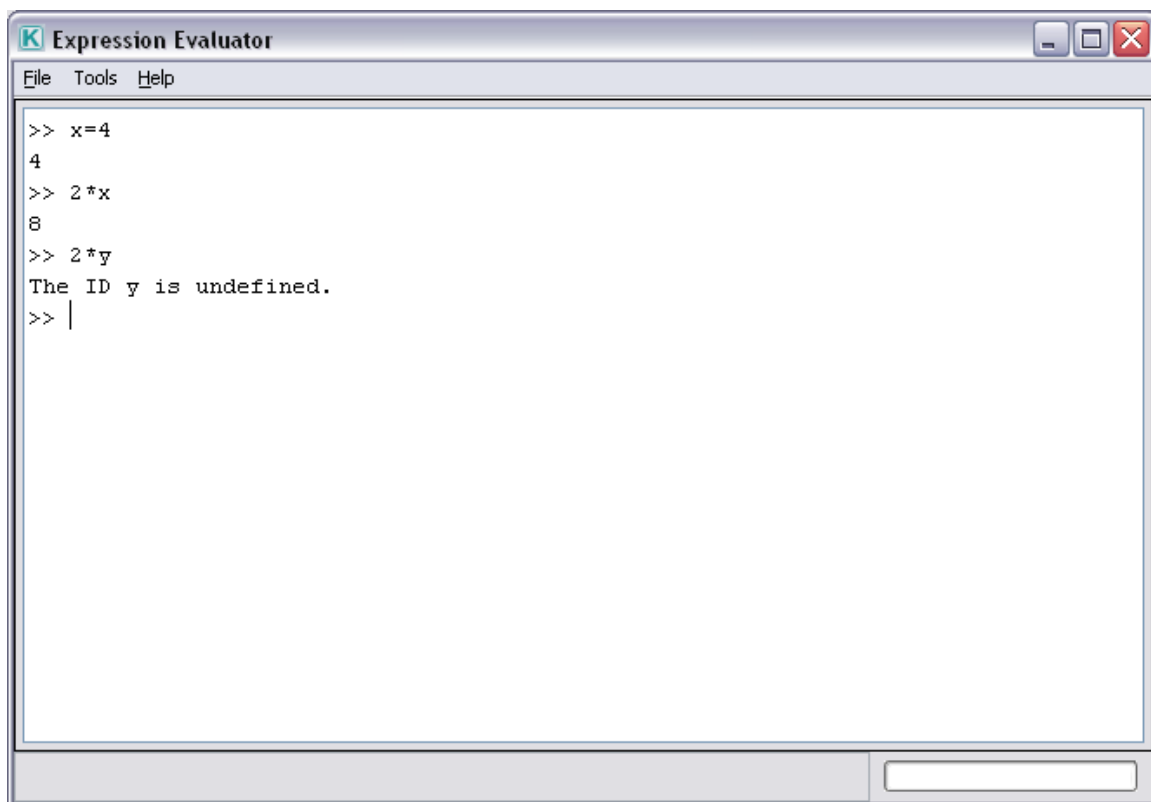

Figure 8.3: Defining a variable. In this example, `x` is defined as 4. `y` is not defined and Kepler cannot evaluate the expression.

Variables are often defined on the Workflow canvas or using parameters. For more information, please see Section 8.1.3.

8.1.1.3 Operators

The Kepler Expression language supports a number of arithmetic, relational, bitwise, and logical Boolean operators (*Table 8.3*). When an operator involves two distinct types, the expression language decides which type to use to implement the operation. If one of the

two types can be converted without loss into the other, then it will be. For instance, *int* can be converted losslessly to *double*, so `1.0/2` will result in 2 being first converted to 2.0, so the result will be 0.5. If the types cannot be converted, an error message will be generated (e.g., "Error evaluating expression "2.0/2L" in `.Expression.evaluator` Because: divide method not supported between `ptolemy.data.DoubleToken '2.0'` and `ptolemy.data.LongToken '2L'` because the types are incomparable.")

Operator	Meaning
Arithmetic Operators	Arithmetic operators operate on most data types, including arrays, records, and matrices
+	The + operator is an addition operation.
-	The - operator is a subtraction operation.
*	The * operator is a multiplication operation.
/	The / operator is a division operation.
^	The ^ operator computes "to the power of" or exponentiation where the exponent can only be an <i>int</i> or an <i>unsignedByte</i> .
%	The % operation is a <i>modulo</i> or <i>remainder</i> operation. The result is the remainder after division. The sign of the result is the same as that of the dividend (the left argument). E.g., <code>3.0%2.0</code> is <code>1.0</code> .
Relational Operators	Relational operators check the values when possible, irrespective of type (e.g., <code>1 == 1.0</code> returns <i>true</i>). If you wish to check for equality of both type and value, use the <code>equals()</code> method.
<	The < operator is LESS THAN
<=	The <+ operator is LESS THAN OR EQUAL
>	The > operator is GREATER THAN
>=	The >= operator is GREATER THAN OR EQUAL
==	The == operator is EQUAL
!=	The != operator is NOT EQUAL
Bitwise Operators	Bitwise operators operate on type <code>boolean</code> , <code>unsignedByte</code> , <code>int</code> and <code>long</code> (but not <code>fixedpoint</code> , <code>double</code> or <code>complex</code>).
&	The & operator is bitwise AND.
	The operator is bitwise OR.
#	The # operator is bitwise XOR (exclusive or, after MATLAB)

~	The ~ operator is bitwise NOT
Logical Boolean Operators	Logical Boolean operators operate on type boolean and return type boolean.
&&	The && operator is logical AND. The difference between logical && and logical & is that & evaluates all the operands regardless of whether their value is now irrelevant. For example, the expression "false && x" will evaluate to <i>false</i> irrespective of whether x is defined. On the other hand, "false & x" will throw an exception.
	The operator is logical OR. The difference between logical and logical is that evaluates all the operands regardless of whether their value is now irrelevant.
!	The ! operator is logical NOT
&	The & operator is logical AND. The difference between logical && and logical & is that & evaluates all the operands regardless of whether their value is now irrelevant. For example, the expression "false && x" will evaluate to <i>false</i> irrespective of whether x is defined. On the other hand, "false & x" will throw an exception.
	The operator is logical OR. The difference between logical and logical is that evaluates all the operands regardless of whether their value is now irrelevant.
	<p>Boolean-valued expressions can be used to give conditional values. The syntax for this is</p> <pre>boolean ? value1 : value2</pre> <p>If the Boolean is true, the value of the expression is <code>value1</code>; otherwise, it is <code>value2</code>.</p>
"Shift" Operators	Shift operators operate on type unsignedByte, int, and long.
<<	The << operator performs an arithmetic left shift.
>>	The >> operator performs an arithmetic right shift.
>>>	The >>> operator performs a logical right shift, which does not preserve the sign.

Table 8.3: Arithmetic, Relational, Bitwise, and Logical Boolean Operators in the Kepler Expression language

8.1.1.4 Arrays

An array is an ordered list of elements. It is specified with curly brackets (e.g., {1,2,3}). An array can consist of elements of any type. The only constraint is that the elements must all have the same type (see *Table 8.4* for examples). If an array is given with mixed types, the expression evaluator will attempt to losslessly convert the elements to a common type. For example, {1, 2.3} has value {1.0, 2.3} (type double). The common type might be *scalar*, which is a union type (a type that can contain multiple distinct types) e.g., (1, 2.3, true) is an array with three elements of scalar type.

Example Arrays	
{1, 2, 3}	An array of type int. The type is denoted {int}
{"x", "y", "z"}	An array of type string. The type is denoted {string}
{2*pi, 3*pi}	An array where the elements are given by expressions
{{1, 2}, {3, 4, 5}}	An array of arrays of integers (a "nested array").
{1, 2.3, true}	An array of scalar type. Scalar is a type that can contain multiple distinct types.

Table 8.4: Examples of arrays

Each element in an array has an index, which is used to access it, and a length, which is equal to the number of elements in the array. The first element has an index of 0, the second 1, etc. To access the second item in the array {1.0, 2.3} (i.e., 2.3) type the following command into the Expression Evaluator:

```
>> {1.0, 2.3}(1)
```

Arithmetic and Logical operators can also be used with arrays. See *Table 8.5* for illustrations.

Example	Result
Arithmetic Operations	Arithmetic operations on arrays are carried out element-by-element. Addition, subtraction, multiplication, division, and modulo of arrays by scalars is also supported. Arrays of length 1 are equivalent to scalars.
{1, 2}*{2, 2}	{2, 4}
{1, 2}+{2, 2}	{3, 4}
{1, 2}-{2, 2}	{-1, 0}
{1, 2}^2	{1, 4}
{1, 2}%{2, 2}	{1, 0}
{1.0, 2.0} / 2.0	{0.5, 1.0}

<code>1.0 / {2.0, 4.0}</code>	<code>{0.5, 0.25}</code>
<code>3 * {2, 3}</code>	<code>{6, 9}</code>
<code>12 / {3, 4}</code>	<code>{4, 3}</code>
<code>{1.0, 2.0} / {2.0}</code>	<code>{0.5, 1.0}</code>
<code>{1.0} / {2.0, 4.0}</code>	<code>{0.5, 0.25}</code>
<code>{3} * {2, 3}</code>	<code>{6, 9}</code>
<code>{12} / {3, 4}</code>	<code>{4, 3}</code>
<code>{{1.0, 2.0}, {3.0, 1.0}} / {0.5, 2.0}</code>	<code>{{2.0, 4.0}, {1.5, 0.5}}</code> Note: A significant subtlety arises when using nested arrays. In this division example, the left argument is an array with two elements, and the right argument is also an array with two elements. The divide is thus elementwise. However, each division is the division of an array by a scalar.
Relational Operations on Arrays	As with scalars, testing for equality using the <code>==</code> or <code>!=</code> operators tests the values, independent of type. For other comparisons of arrays, use the <code>compare()</code> function.
<code>{1, 2}=={2, 2}</code>	<code>false</code>
<code>{1, 2}!={2, 2}</code>	<code>true</code>
<code>{1, 2}=={1.0, 2.0}</code>	<code>true</code>
Extracting Elements from an Array	To extract elements from an array use either the <code>subarray()</code> or <code>extract()</code> methods.
<code>{1, 2, 3, 4}.subarray(2, 2)</code>	<code>{3, 4}</code> The first argument is the starting index of the subarray, and the second argument is the length.
<code>{"red","green","blue"}.extract({true,false,true})</code>	<code>{"red", "blue"}</code> The <code>extract()</code> method can take a boolean array of the same length as the original array which indicates which elements to extract.
<code>{"red","green","blue"}.extract({2,0,1,1})</code>	<code>{"blue", "red", "green", "green"}</code> The <code>extract()</code> method can also take an array of integers giving the indices to extract.

Table 8.5: Performing operations on arrays

8.1.1.5 Matrices

Matrices are more specialized than arrays and are intended for data intensive computations. They are specified with square brackets, using commas to separate row elements and semicolons to separate rows. For example, “[1, 2, 3; 4, 5, 5+1]” gives a two by three integer matrix (2 rows and 3 columns). For more examples of matrices, please see *Table 8.6*.

Matrices can contain only certain primitive types: boolean, complex, double, fixedpoint, int, and long. Currently unsignedByte matrices are not supported. If a matrix with mixed types is specified, then the elements will be converted to a common type, if possible. Thus, for example, “[1.0, 1]” is equivalent to “[1.0, 1.0],” but “[1.0, 1L]” is illegal (because there is no common type to which both elements can be converted losslessly).

Example Matrices	Notes
[1, 2, 3]	A row vector
[1; 2; 3]	A column vector
[1:2:9]	A MATLAB-style constructor giving an array of odd numbers from 1 to 9. In the syntax “[p:q:r]”, p is the first element, q is the step between elements, and r is an upper bound on the last element. The value is equivalent to [1, 3, 5, 7, 9].
[1:2:9; 2:2:10]	A MATLAB-style constructor. In the syntax “[p:q:r]”, p is the first element, q is the step between elements, and r is an upper bound on the last element. equivalent to [1, 3, 5, 7, 9; 2, 4, 6, 8, 10]

Table 8.6: Examples of matrices.

Each matrix element can be referenced by its row and column index. Index numbers start with 0. For example, [1,2;3,4](0,0) returns the element at row and column index 0—i.e., 1.

Arithmetic and logical operators can also be used with matrices. See *Table 8.7* for illustrations. Matrix addition and subtraction are element wise, as expected, but the division operator is not supported (you must use the divideElements() function). Multiplication by a matrix inverse can be accomplished using the inverse() function.

Example	Results and notes
Multiplying matrices	

<code>[1, 2; 3, 4]*[2, 2; 2, 2]</code>	<code>[6, 6; 14, 14]</code> If the dimensions of the matrix don't match, then you will get an error message. To do element wise multiplication, use the <code>multiplyElements()</code> function
<code>[3, 0; 0, 3]*3</code>	<code>[9, 0; 0, 9]</code> In this example, a matrix is multiplied by a scalar.
Raising a matrix by an integer	
<code>[3, 0; 0, 3]^3</code>	<code>[27, 0; 0, 27]</code> A matrix can be raised to an <i>int</i> or <i>unsignedByte</i> power, which is equivalent to multiplying it by itself some number of times.
Subtracting and adding matrices	
<code>1-[3, 0; 0, 3]</code>	<code>[-2, 1; 1, -2]</code> In this example, a matrix is subtracted from a scalar.
<code>[1,2;3,5]+[3,5;4,7]</code>	<code>[4, 7; 7, 12]</code> Two matrices are added elementwise. If the dimensions of the matrices don't match, Kepler will generate an error message.
Testing matrices for equality	
<code>[3, 0; 0, 3]!= [3, 0; 0, 6]</code>	<code>True</code> In this example, two matrices are checked for inequality.
<code>[3, 0; 0, 3]== [3, 0; 0, 3]</code>	<code>True</code> In this example, two matrices are checked for equality.
<code>[1, 2]==[1.0, 2.0]</code>	<code>True</code> As with scalars, testing for equality using the <code>==</code> or <code>!=</code> operators tests the values, independent of type.
<code>[1, 2].equals([1.0, 2.0])</code>	<code>False</code> Use the <code>equals()</code> method to perform a type specific test.

Table 8.7: Performing operations on matrices

8.1.1.6 Records

A record token is a composite type containing named fields, where each field has a value. The value of each field can have a distinct type. Records are delimited by curly braces. For example, “`{a=1, b="foo"}`” is a record with two fields, named “a” and “b”, with values 1 (an integer) and “foo” (a string), respectively.

Fields can be accessed using the period operator. For example:

```
{a=1,b=2}.a
```

yields 1. You can optionally write this as if it were a method call:

```
{a=1,b=2}.a()
```

The arithmetic operators +, -, *, /, and % can be applied to records. See *Table 8.8* for examples.

Example	Result and notes
Adding records	
<pre>{foodCost=40, hotelCost=100} + {foodCost=20, taxiCost=20}</pre>	<pre>{foodCost=60}</pre> If the records do not have identical fields, then the operator is applied only to the fields that match, and the result contains only the fields that match.
Merging records	
<pre>merge({a=1, b=2}, {a=3, c=3})</pre>	<pre>{a=1, b=2, c=3}</pre> . Records can be joined using the merge() function. This function takes two arguments, both of which are record tokens. If the two record tokens have common fields, then the field value from the first record is used.
Finding the intersection of two records	
<pre>intersect({a=1, c=2}, {a=3, b=4})</pre>	<pre>{a=1}</pre> Use the intersect() function to form a record that has only the common fields of two specified records, with the values taken from the first record.
Comparing records	
<pre>{a=1, b=2}=={b=2, a=1}</pre>	True When comparing records, the order of the fields is irrelevant.
<pre>{a=1, b=2}=={a=1, b=2}</pre>	true
<pre>{a=1, b=2}!={a=1, c=2}</pre>	True
<pre>{a=1, b=2}=={a=1.0, b=2.0+0.0i}</pre>	True Note that two records are equal only if they have the same field labels and the values match. As with scalars, the values match irrespective of type.
<pre>{a=1, b=2}.equals({a=1.0, b=2.0+0.0i})</pre>	false To perform type-specific equality tests, use the equals() method
<pre>{a=1, b=2}.equals({b=2, a=1})</pre>	true

Table 8.8: Performing operations on records.

8.1.1.7 Methods

Each of the different types of expressions—constants, records, matrices, etc—are represented by tokens, and these tokens have a number of associated methods. For example, array tokens have a `length()` method that is used to return the number of contained elements. A record token has a `length()` method as well. To see what methods are available for each type of token, see the [Ptolemy online documentation](#). Most of the relevant tokens belong to a class derived from `token`, e.g., an integer token is a subclass of the scalar token class, which in turn is a subclass of `token`.

The syntax for using methods with expressions is: `(token).methodName(args)` where `methodName` is the name of the method and `args` is a comma-separated set of arguments. Each argument can itself be an expression. Note that the parentheses around the `token` are not required, but might be useful for clarity. For examples, please see *Table 8.9*.

Example	Result and notes
<code>{1, 2, 3}.length()</code>	3 Using the <code>length()</code> method with an array token
<code>{a=1, b=2, c=3}.length()</code>	3 Using the <code>length()</code> method with a record token
<code>[1, 2; 3, 4; 5, 6].getRowCount()</code>	3 Using the <code>getRowCount()</code> method with a matrix token
<code>[1, 2; 3, 4; 5, 6].getColumnCount()</code>	2 Using the <code>getColumnCount()</code> method with a matrix token
<code>[1, 2; 3, 4; 5, 6].toArray()</code>	{1, 2, 3, 4, 5, 6} Using the <code>toArray()</code> method with a matrix token
<code>[1:1:100].toArray()</code>	The latter function can be particularly useful for creating arrays using MATLAB-style syntax. For example, to obtain an array with the integers from 1 to 100, you can enter:

Table 8.9: Using methods with expression tokens

8.1.1.8 Functions

The expression language supports the definition of functions—sets of instructions that perform a specific task and return the result. Functions are defined using the keyword `function` followed by the arguments to pass to the function and their types, followed by

the function body (i.e., `function(arg1:Type, arg2:Type...) function body`). For example:

```
function(x:double) x*5.0
```

The above function takes a double argument (`x:double`), multiplies it by 5.0, and returns a double. To apply this function to a specified argument, simply type the function into the Expression Evaluator followed by the argument, which is specified in parenthesis:

```
>> (function(x:double) x*5.0) (10.0)
50.0
```

Alternatively, you can assign the function to a variable, and then use the variable name to apply the function. For example,

```
>> f = function(x:double) x*5.0
(function(x:double) (x*5.0))
>> f(10)
50.0
>>
```

Note: when defining a function, the type of an argument can be left unspecified, in which case the expression language will attempt to infer it. The return type is always inferred based on the argument type and the expression.

Functions can be passed as arguments to certain “higher-order functions” that have been defined. For example, the `iterate()` function takes three arguments, a function, an integer representing the length of the array to generate, and an initial value to which to apply the function. For example, to get an array of five elements whose values are multiples of 3, you could use the following:

```
>> iterate(function(x:int) x+3, 5, 0)
{0, 3, 6, 9, 12}
```

The function given as an argument simply adds three to its argument. The result is the specified initial value (0) followed by the result of applying the function once to that initial value, then twice, then three times, etc.

Another useful higher-order function is the `map()` function. The `map()` function takes a function and an array as arguments, and simply applies the function to each element of the array to construct a result array:

```
>> map(function(x:int) x+3, {0, 2, 3})
{3, 5, 6}
```

The `map()` function is often used in workflows that define a parameter whose value is a function. Suppose that the parameter named “f” has the value `function(x:double) x*5.0`. Then the expression “`f(10.0)`” will yield result 50.0, providing the parameter is in scope.

For more information about predefined functions, including tables of supported functions, please see the [Chapter 3, Appendix A of the Ptolemy User Manual](#).

8.1.2 Expressions and Parameters

The value of parameters is an expression, from a simple integer to a more complex combination of operations and constants. For example, consider the following workflow parameter named `DataDirectory`:

- `DataDirectory: property("KEPLER")+"/lib/testdata/"`

The value of the `DataDirectory` parameter is an expression `"property("KEPLER")+"/lib/testdata/"`. `'property("KEPLER")'` returns the path to the directory in which Kepler is installed. `"/lib/testdata"` is the path to the desired sub-directory. Using an expression of this type allows the path to be evaluated properly no matter where the Kepler system is installed in the file system.

8.1.3 Expressions and Port Parameters

A port parameter functions as both a port and a parameter that is used to configure the operation of an actor (for more information about port parameters, see *Chapter 3*). Port-parameters allow users to specify a value for a parameter (e.g., `iterations=4` or `name="mouse"`), and to allow that value to be "updated" via a coupled port. If a value is received via the port component of the port parameter, that value will replace the value specified by the parameter component. For example, the *Sinewave* actor, which is a composite actor found in the standard Kepler component library, has two port parameters, `frequency` and `phase` (*Figure 8.4*):

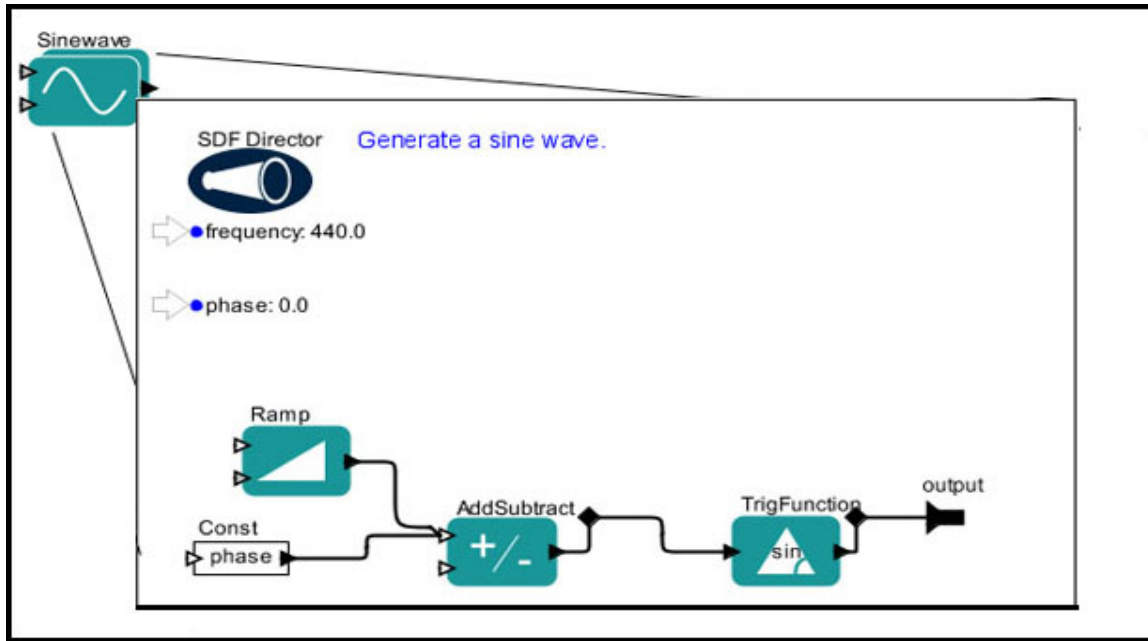

Figure 8.4: Inside the *Sinewave* composite actor, which uses two port parameters.

The port parameters specify the "default" values for these two items. The values specified on the Workflow canvas are also visible in the *Sinewave* actor's parameters, opened when the *Sinewave* actor is double-clicked (*Figure 8.5*).

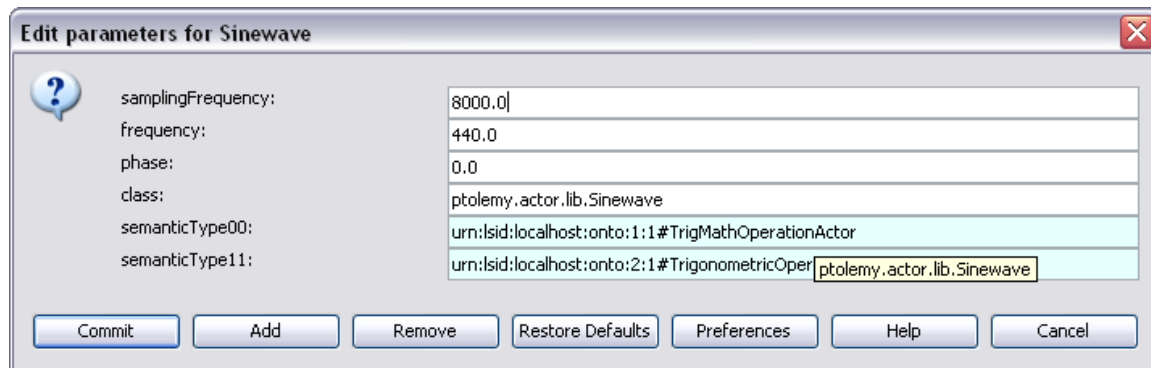

Figure 8.5: The parameters of the *Sinewave* actor. *frequency* and *phase* are port parameters. The parameter value will be overridden if the corresponding port receives a value.

The *Ramp* actor found inside the *Sinewave* composite actor references the port parameter in its parameters (*Figure 8.6*):

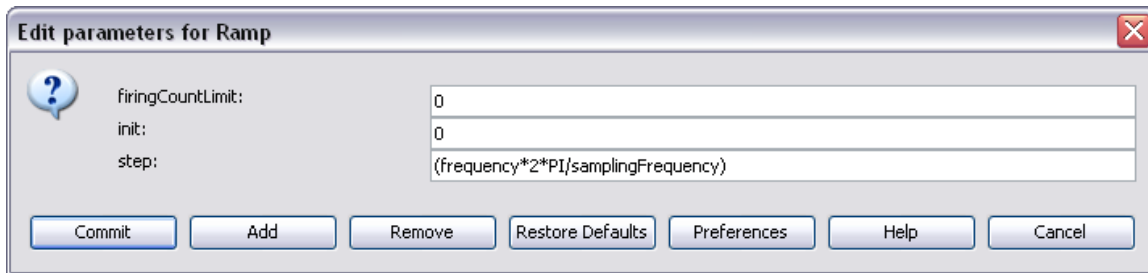

Figure 8.6: The parameters of the Ramp actor found inside the Sinewave composite actor.

Note how the value of the *Ramp* actor's step parameter references the frequency port-parameter by name: $(frequency * 2 * \pi / samplingFrequency)$.

8.1.4 Expressions and String Parameters

Some parameters have values that are always strings of characters. Such parameters support a simple string substitution mechanism where the value of the string can reference other parameters in scope by name using the syntax $\$name$, where $name$ is the name of the parameter in scope.⁴¹ The simple workflow in *Figure 8.7* uses the $\$name$ syntax to reference the value of the salutation parameter.

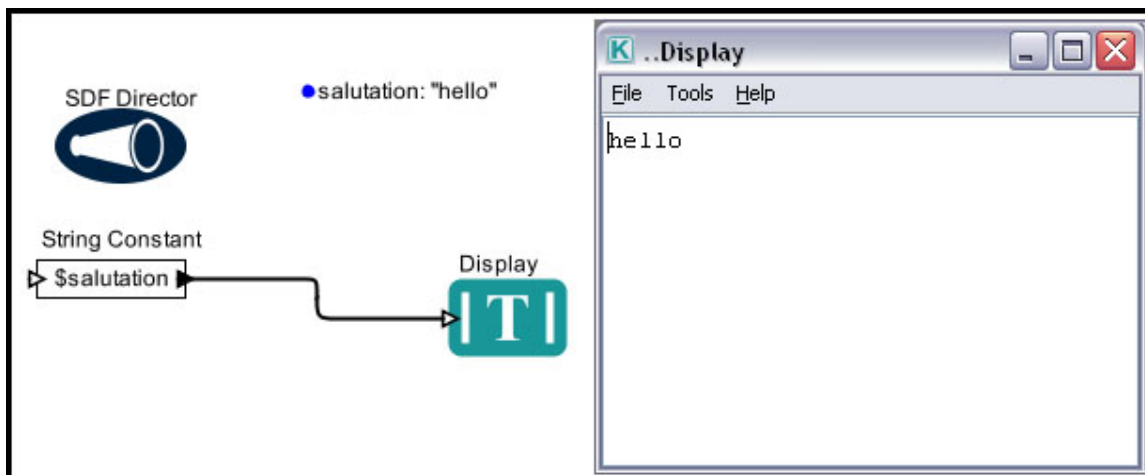

Figure 8.7: Using the $\$name$ syntax to reference a string parameter.

8.1.5 The Expression Actor

The *Expression* actor can be used to evaluate an expression. The simple workflow in *Figure 8.8* is used to evaluate the expression $\pi/2$ and display the result. The expression ($\pi/2$) is specified by the actor parameter in this case.

⁴¹ Ptolemy documentation: <http://www.eecs.berkeley.edu/Pubs/TechRpts/2007/EECS-2007-7.html>

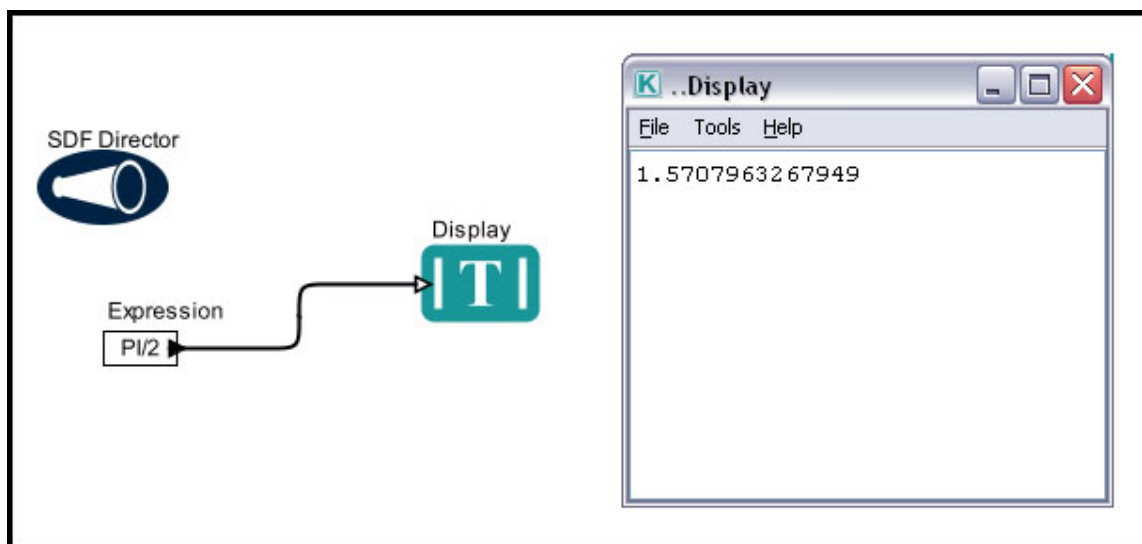

Figure 8.8: The *Expression* actor used to evaluate an expression specified in its parameters.

The *Expression* actor is particularly useful when it comes to evaluating expressions that use variables passed by other actors. Consider the LotkaVolterraPredatorPrey workflow displayed in *Figure 8.9*. This workflow is used to solve two coupled differential equations that model the relationship between predator and prey populations. Note: The workflow can be found in the KeplerData/workflows/module/outreach-2.X.Y/demos/getting-started/demos/getting-started/ directory, and full documentation and step-by-step instructions for creating and using it can be found in the Getting Started Guide. The important thing to note at the moment are the two *Expression* actors used in the workflow (named $dn1/dt$ and $dn2/dt$)

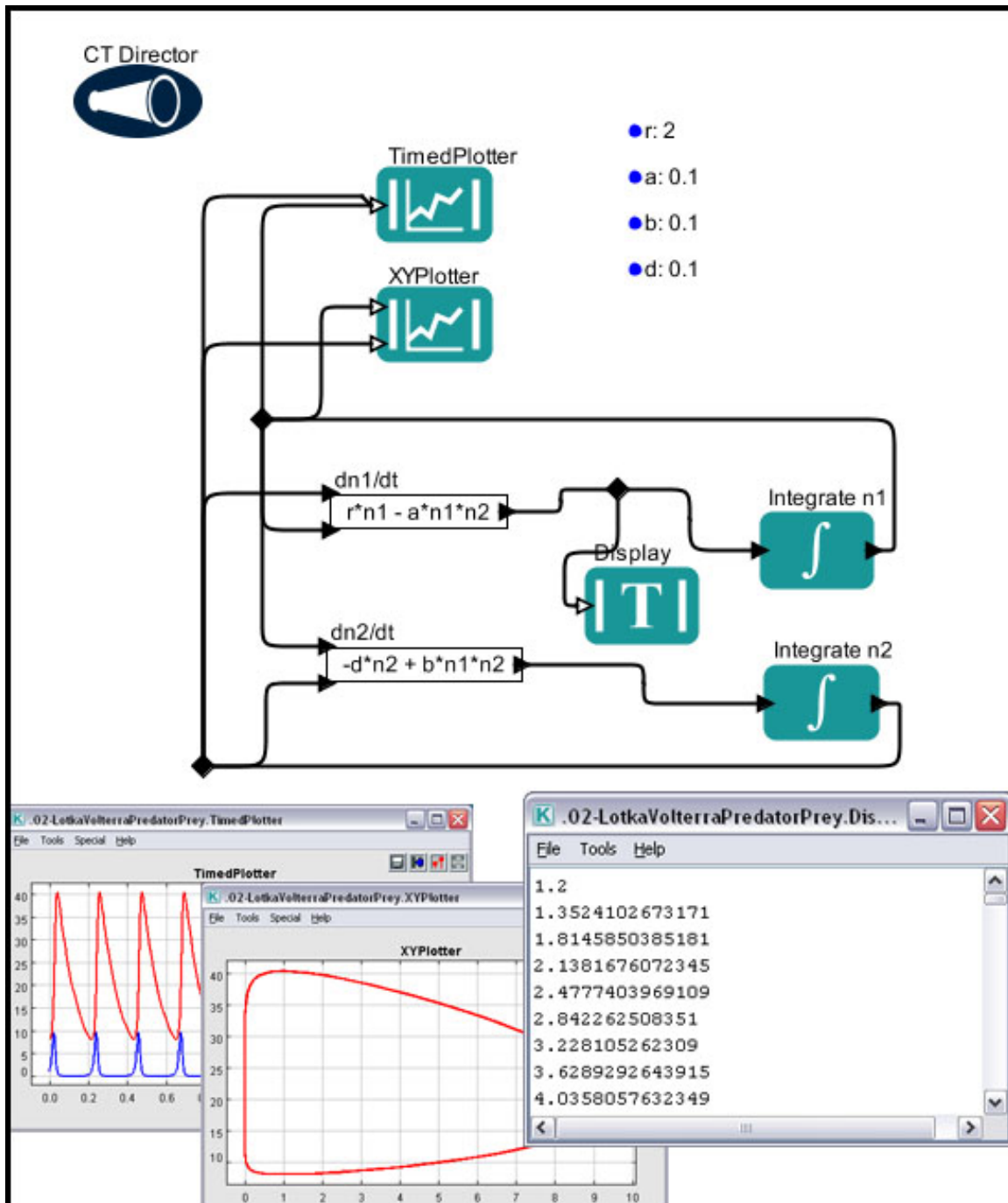

Figure 8.9: The LotkaVolterraPredatorPrey workflow, which uses two *Expression* actors to evaluate differential equations.

By default, the *Expression* actor has one output and no input ports. Users can define input ports used to pass variables to the actor. For example, the $dn1/dt$ actor displayed in *Figure 8.10* has two user-defined input ports named $n1$ and $n2$.

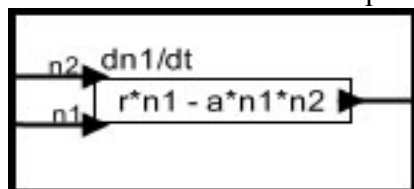

Figure 8.10: *Expression* actor with two user-defined ports

The port names identify the values that are passed through the channels to the actor. The actor can then use those values when it evaluates the expression. For example, if the token passed through $n1$ is an integer with a value of 5 and the token passed through $n2$ has a value of 2, then the *Expression* actor will evaluate the expression $(r*n1 - a*n1*n2)$ and output the result (9, which is $2*5 - 1*5*2$). Note that the *Expression* actor can reference workflow parameters (in the LotkaVolterra example, r and a are parameters defined on the Workflow canvas).

Expression actors can also be useful for generating a series of files or file names. The workflow in *Figure 8.11* uses an *Expression* actor in conjunction with a *Ramp* and *TextFileWriter* actor to name and write three unique files to the working directory.

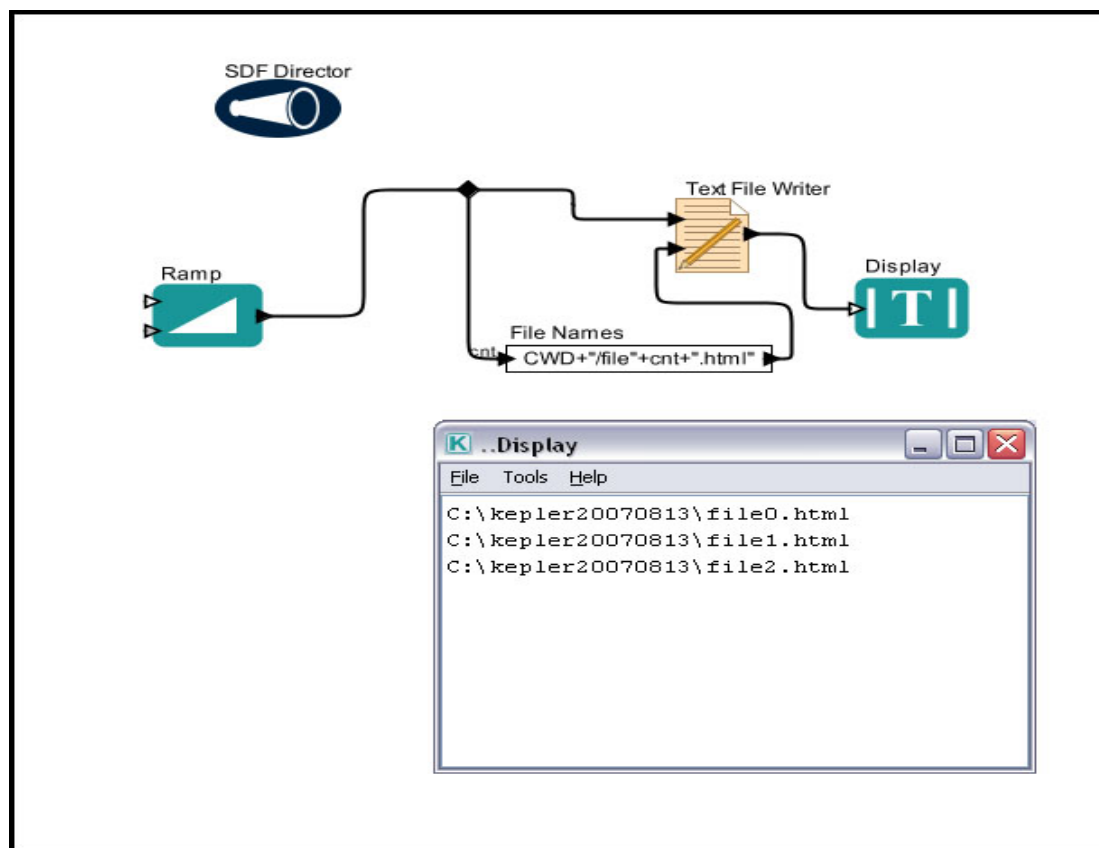

Figure 8.11: Using the *Expression* actor (*File Names*) with a *Ramp* actor to generate unique file names.

In the example above, the *Ramp* actor has been set to fire three times, augmenting its step by 1 each time (Figure 8.12). The *Ramp* actor will output 0,1,2 (the initial value specified by the `int` parameter, and then incremented by the amount of the `step` until the firing limit is met).

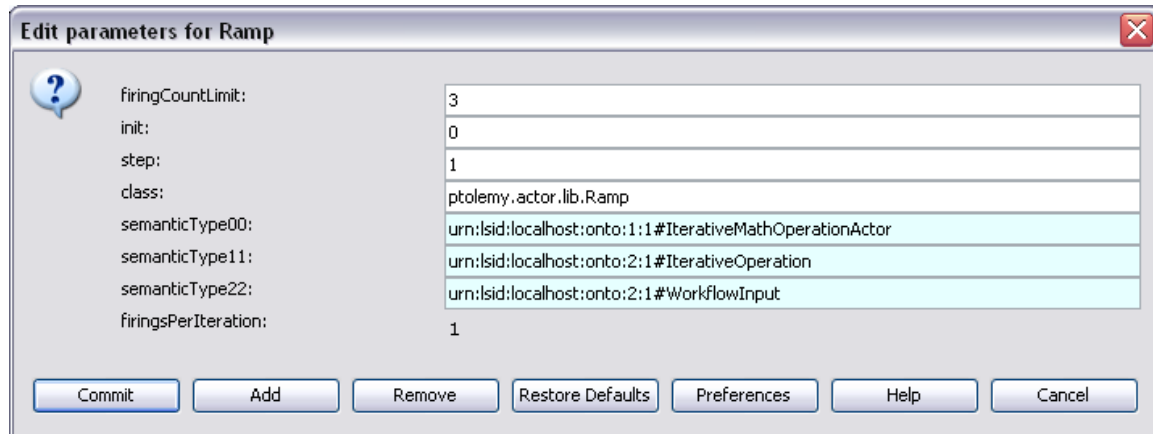

Figure 8.12: Parameters of the *Ramp* actor.

The count generated by the *Ramp* actor is input into an *Expression* actor named *File Names* via a user-defined input port named `cnt`. The *Expression* actor evaluates the specified expression (`CWD+"/file"+cnt+".html"`). `CWD` is a built-in string-valued constant referring to the current working directory (in this case, `C:\kepler20070813`). `"/file"` and `".html"` are strings, which the actor adds to the current working directory and the count to form three unique file names: `C:\kepler20070813\file0.html`, `C:\kepler20070813\file1.html`, and `C:\kepler20070813\file2.html`. These file names are input to a *TextFileWriter* actor, which creates and saves the files in the specified location.

8.2 Statistical Computing: Kepler and R

Kepler users with little background in computer science can create workflows that execute statistical analyses via Kepler's suite of useful R actors. Users need not know how to program in R in order to take advantage of its powerful analytical features; pre-programmed Kepler components can simply be dragged into a visually represented workflow.

Note: To implement any of the R actors, R must be installed on the computer running the Kepler application. See Section 8.2.2 for more information about installing R.

8.2.1 What is R?

R is free software for statistical computing, data manipulation, and graphics. Based on work originally carried out at Bell Labs, R is part of the GNU project. R provides a wide variety of statistical (linear and nonlinear modeling, classical statistical tests, time-series analysis, classification, clustering, ...) and graphical techniques, and is highly extensible (*Figure 8.13*).⁴²

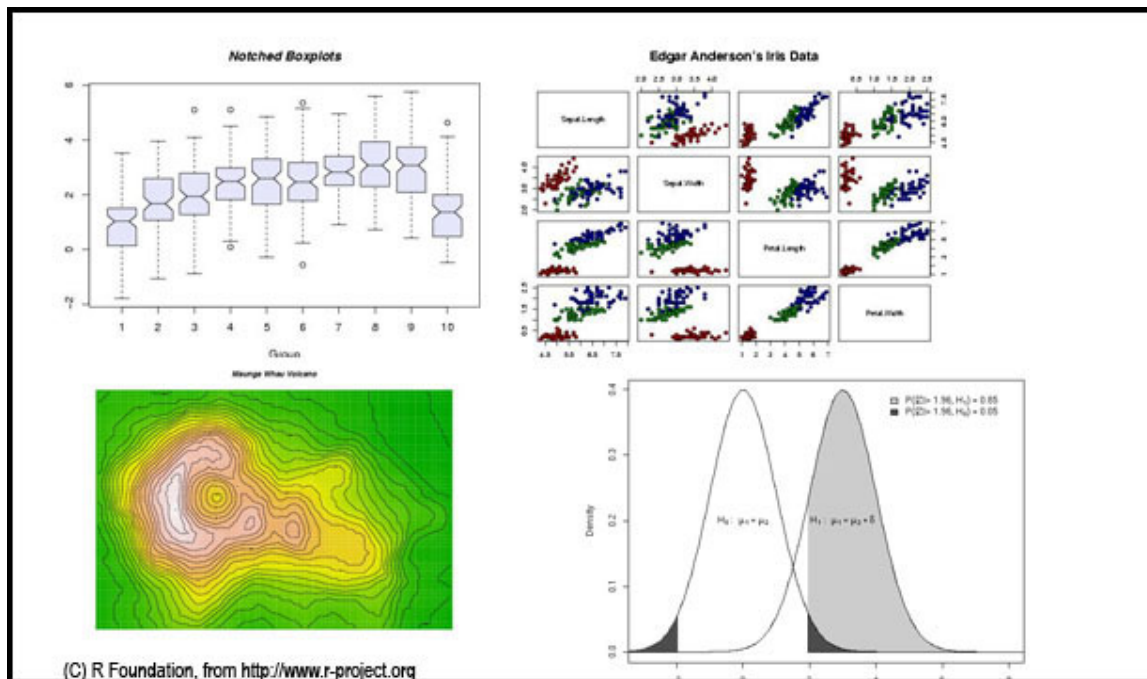

Figure 8.13: Examples of graphics generated with R

The *RExpression* actor has been created for inserting R commands and scripts into Kepler workflows. This actor makes it easy to integrate the powerful data manipulation and statistical functions of R into workflows. In addition, a number of customized R actors designed to perform specific functions (creating a Bar or Box plot, for example) are included in the Kepler library. See Section 8.2.3 for a list of useful R actors, or the R appendix for detailed examples. A search for "RExpression" in the Components tab will return all R-related actors.

8.2.2 Installing R

R is included with the Kepler installer for Windows and Macintosh, and will be installed and configured automatically with a full Kepler installation. R is not included with the Linux installer.

R can also be freely downloaded from links on the R Project web site (<http://www.r-project.org>). Follow the instructions provided for installation. In addition, the R 'bin'

⁴² R Project website, <http://www.r-project.org/>

directory must be added to the PATH variable on the host computer. To test if the installation is correct, open a command/terminal window and type the command 'R'. The command should startup the R environment and alert the user that R has been started.

8.2.3 Useful R Actors

The Kepler library contains a number of useful R actors, described in Table 8.10.

Useful R Actors	
	<p>The RExpression actor runs an R script or function. Input and output ports are created by the user and correspond to R variables used in the specified R script. The actor outputs the result of the evaluated script.</p>
ANOVA	<p>The ANOVA actor uses R to perform a variance analysis on input data. The actor outputs a graphical representation of its calculations.</p>
Barplot	<p>The Barplot actor creates and saves a simple barplot graph. The actor outputs the path to the barplot graph and (optionally) display the graph itself.</p>
Boxplot	<p>The Boxplot actor creates and saves a boxplot. The actor reads an array of values and, optionally, an array over which the values are divided (an array of dates, for example). The actor outputs the path to the saved boxplot and (optionally) displays the graph.</p>
Correlation	<p>The Correlation actor uses R to perform parametric and non-parametric tests of association between two input variables (e.g., two arrays of equal length). The actor outputs the level of association (r, rho, or tau, depending on the analysis) between the two variables, an estimate of the p-value (if possible), and n.</p>
LinearModel	<p>The LinearModel actor runs a variance or linear regression analysis on its inputs and outputs the result.</p>
RandomNormal	<p>The RandomNormal actor uses an R-script to generate and output a set of normally (Gaussian) distributed numbers with a mean of 0 and a standard deviation of 1. The actor outputs an array of the generated integers as well as the file path to a graphical representation of the distribution.</p>
RandomUniform	<p>The RandomUniform actor uses an R-script to generate and output a set of uniformly distributed numbers. The actor outputs an array of the generated integers as well as the path to a graphical representation of the distribution.</p>
ReadTable	<p>The ReadTable actor reads a text-based data file on the local file system and outputs the data in a format that can be used by other R actors.</p>

Regression	The Regression actor uses R to run a variance or linear regression analysis. The actor accepts an independent and a dependent variable. If the independent variable is categorical, the actor uses R to run a variance analysis (or a t-test if the variable has only 2 categories). If the independent variable is continuous, a linear regression is run. The actor outputs both a graphical and textual representation of the analysis.
RMean	The RMean actor accepts an array of values and uses R to calculate their mean. The actor outputs both a graphical and textual representation of the analysis.
RMedian	The RMedian actor accepts an array of values and uses R to calculate their median. The actor outputs both a graphical and textual representation of the analysis.
RQuantile	The RQuantile actor accepts an array of values and uses R to produce sample quantiles. The actor outputs both a graphical and textual representation of the analysis.
Scatterplot	The Scatterplot actor reads an independent and a dependent variable, which are specified as arrays of values. The actor creates a simple scatter plot based on the input, and outputs the path to the generated graph file.
Summary	The Summary actor uses R to calculate a specified summary statistic. The actor accepts a number of factors and a variable, and outputs the specified summary statistic (e.g., presence, mean, standard deviation, variance, etc).
SummaryStatistics	The SummaryStatistics actor accepts an array of values and uses R to calculate their mean, standard deviation, and variance. The actor outputs both a graphical and textual representation of the summary analysis.

Table 8.10: Useful R actors

For example workflows using the above R actors, please see the R Appendix.

8.2.4 Working with R Actors

Using default and user-defined ports and R-scripts, Kepler's R actors can be used to perform a wide variety of statistical and analytical calculations. In this section, we will take a closer look at the RExpression actor as well as several sample R workflows that demonstrate the power and flexibility of the integrated applications.

8.2.4.1 Using the RExpression Actor

The RExpression actor runs the R script or function specified in its parameters. To view or change this R script, double-click the actor. By default, the actor creates and saves a simple plot of an array of values using the script displayed in *Figure 8.14*.

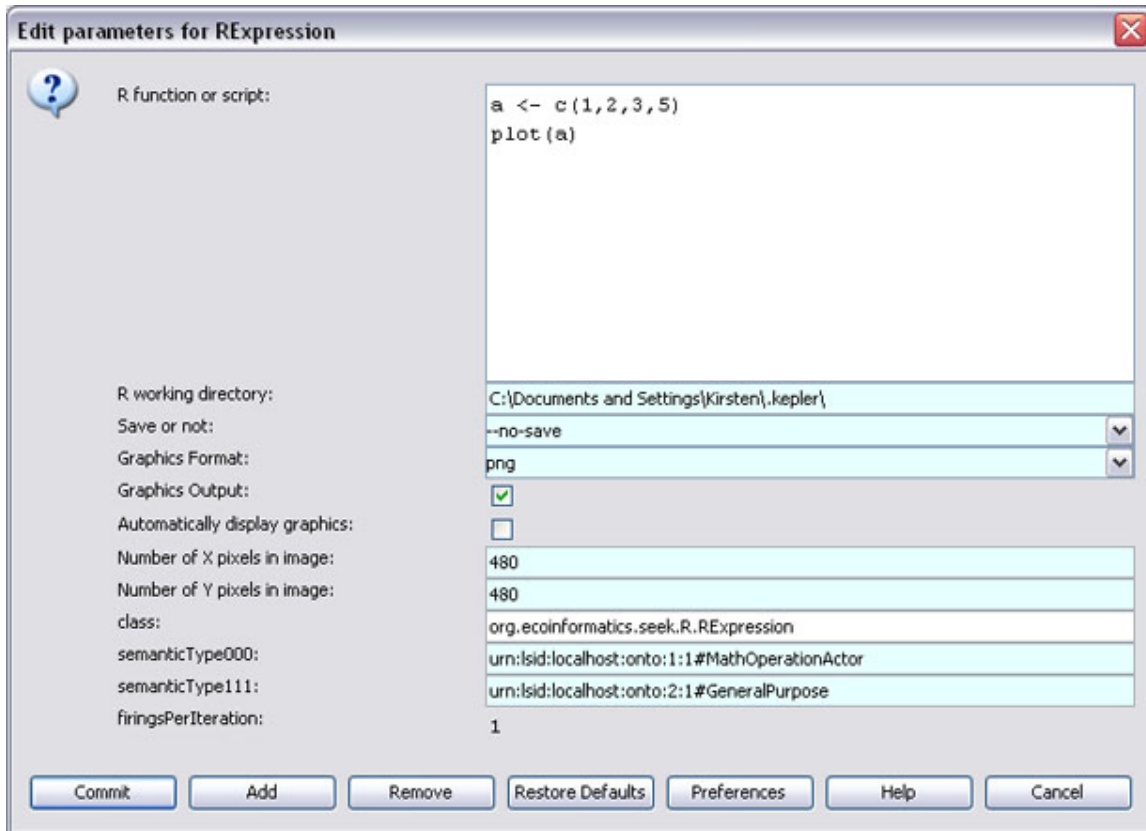

Figure 8.14: The default parameters of the *RExpression* actor.

The *RExpression* actor outputs a graphical representation of its result as well a copy of the text output that R generates. The text output consists of the actor's communications with R to run the R function or script and the values and statistical outputs. *Figure 8.15* displays a very simple R workflow that shows the text and graphical display of an *RExpression* actor with its default settings.

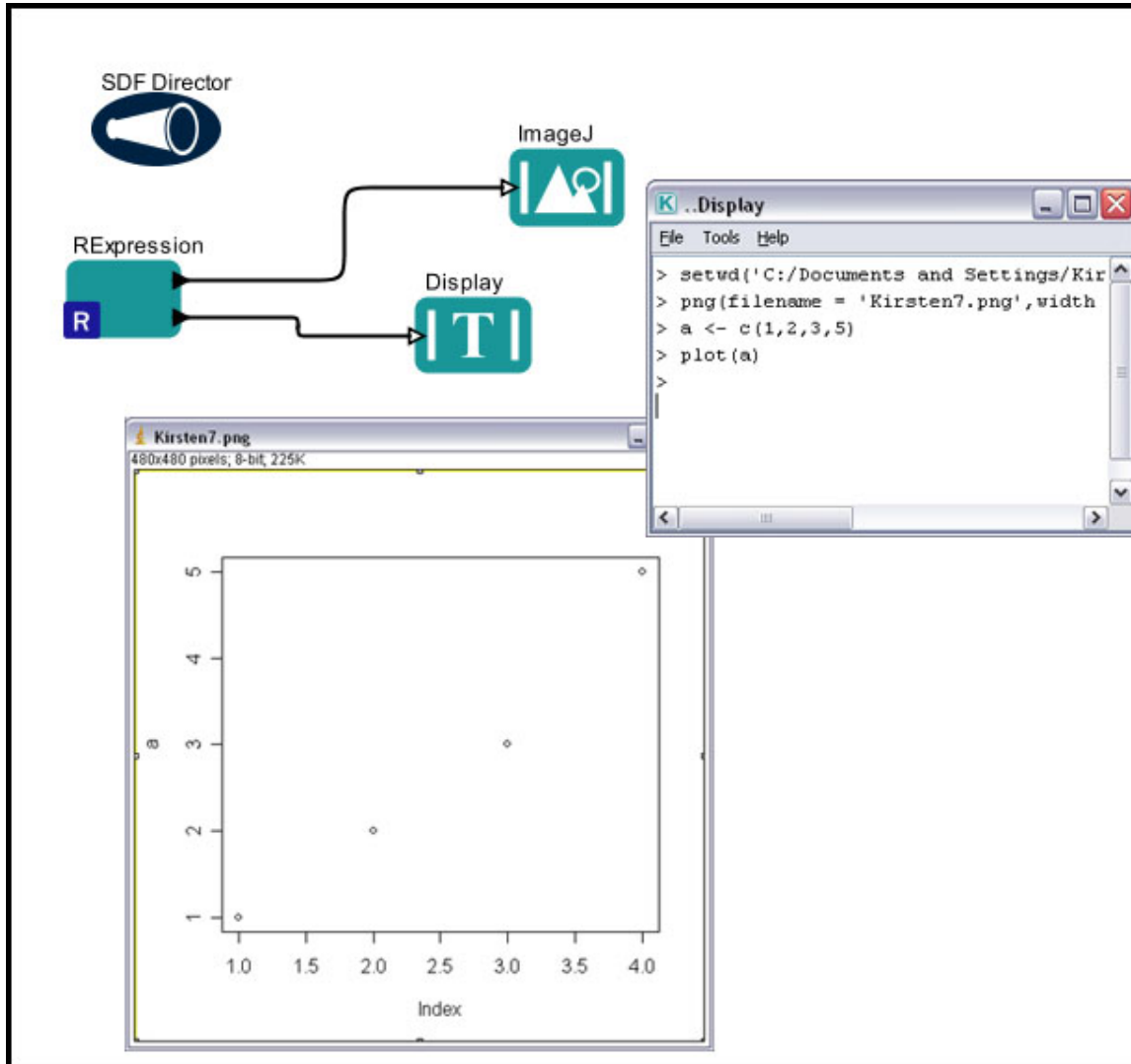

Figure 8.15: The default settings of the *RExpression* actor. The actor creates a simple plot of the values (1,2,3,5).

The first two lines in the text display window in the upper right corner of *Figure 8.15* (`setwd...` and `png...`) are setup commands for R that are automatically added by the actor. The last two lines of the display are exactly what would appear if one were running the R system from the command line:

```
> a <-c(1,2,3,5)
> plot(a)
```

Additional ports can be added the *RExpression* actor to provide inputs or outputs. The names of the additional input ports become named R objects used in the R script. For example, the *RExpression* actor in *Figure 8.16* has two user-defined input ports named `aaa` and `bbb` (for information about adding and customizing ports, see Section

3.2.4.1). Two *Expression* actors are used to pass arrays to these new ports, where an R script can reference the values by the port name. The R script has been set to `aaa+bbb`, where `aaa` is `{1,2,3}` and `bbb` is `{4,5,6}` (i.e., the values passed through the correspondingly named ports).

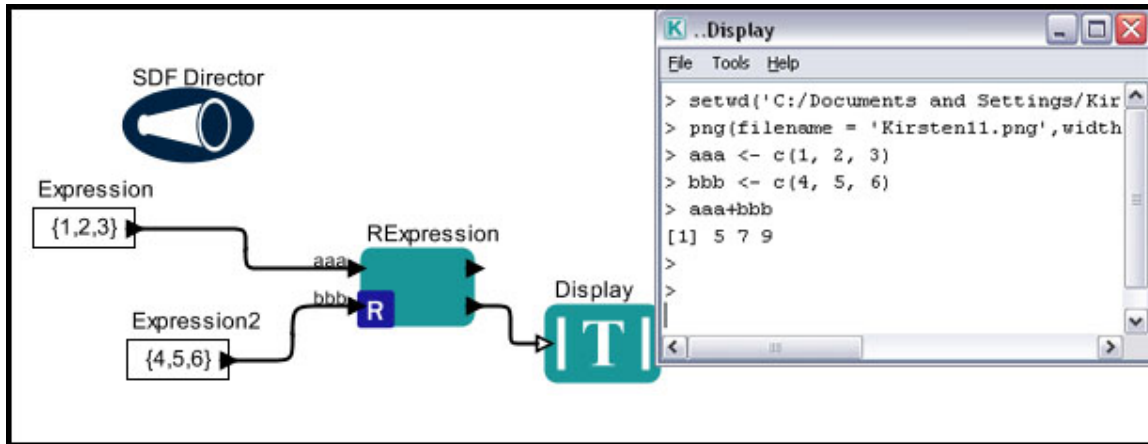

Figure 8.16: Two user-defined ports have been added to an *RExpression* actor.

The Display window contains the workflow output and the text generated by R: `aaa = 1 2 3`; `bbb = 4,5,6`; and `aaa+bbb = 5, 7, 9` (i.e., $1+4$, $2+5$, $3+6$). If `aaa` and `bbb` were simple scalar values (e.g., 1 or 17.5), then this *RExpression* actor would have simply duplicated the functionality of the *Expression* actor. However, the base data type of the R system is the vector (similar to the Kepler array). Thus the result consists of the corresponding input array elements added together.

Figure 8.17 shows a variation of the previous workflow. The R-script has been modified to instruct the *RExpression* actor to plot the sum of the inputs instead of outputting them as text:

```
ccc <- aaa + bbb
barplot(ccc)
```

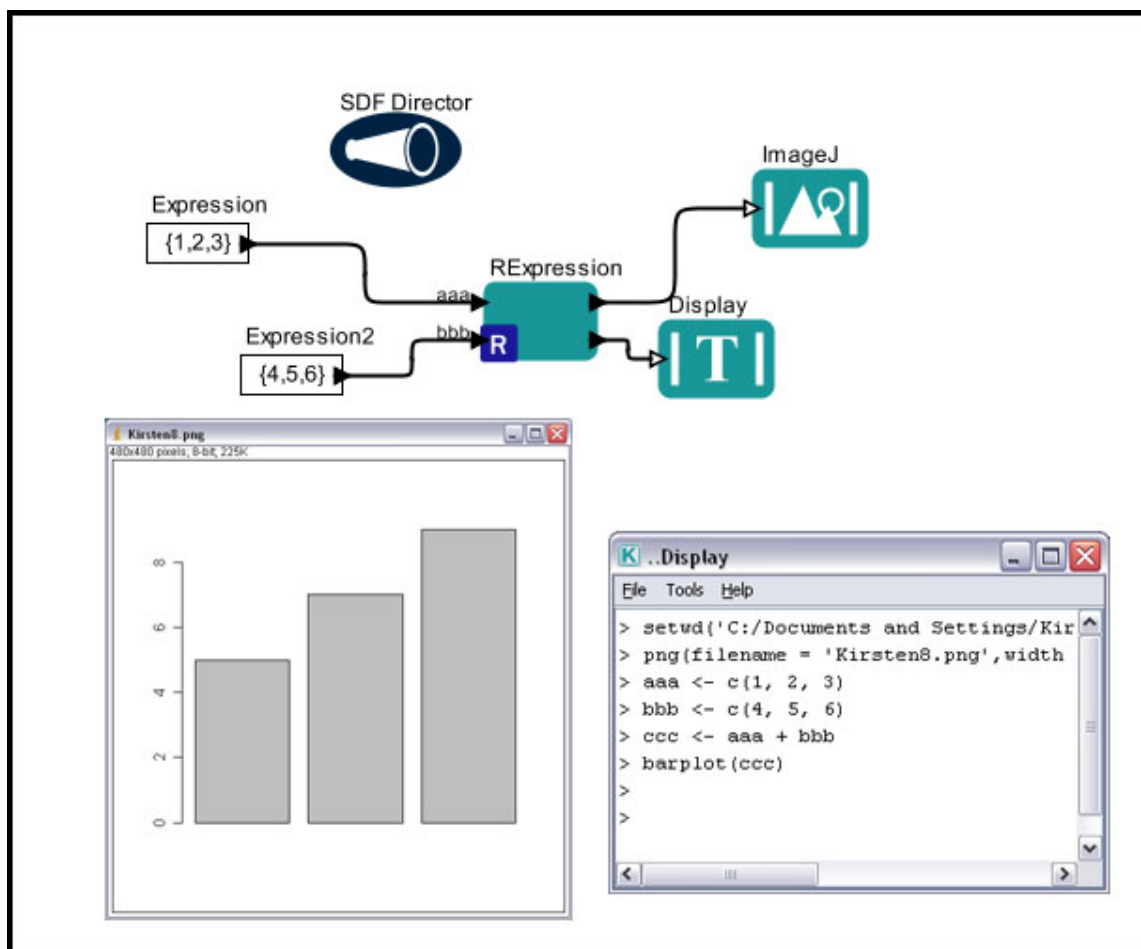

Figure 8.17: An example of an *RExpression* workflow used to create a plot of the output.

In the above workflow, the graphical output is saved as a .png file (the default). The *RExpression* actor can also generate and save a .pdf file—set the desired output type with the `GraphicsFormat` parameter. The dimensions of the graphic can be customized with the `NumberOfXPixelsInImage` and `NumberOfYPixelsInImage` parameters. By default, the graphic is 480x480 pixels. Note that generated graphics files are saved to the R working directory, which by default is the Kepler cache (e.g., `C:\Documents and Settings\\kepler\`).

For more information about working with R in Kepler, please see the R Appendix of the User Manual.

8.2.4.2 Using EML Datasets with the *RExpression* Actor

EML datasets can be accessed and used in a variety of ways that are useful to R analyses. In the following section, we'll look at how the *RExpression* actor can perform custom statistical analyses--over two data variables, several variables, or the entire `Datos`

Meteorologicos dataset (which consists of EML-described meteorological data collected from the La Hechicera station in 2001) using R-scripts and appropriate input data formats: arrays, records, or data tables, respectively. For more information about EML, please see Chapter 6.

Using Arrays with the RExpression Actor

The data array, or vector in R, is commonly used as the data format for information processed by the *RExpression* actor. The workflow in *Figure 8.18* shows an example of a workflow used to process two data variables (the *RExpression* actor is used to perform a simple linear regression analysis) that are passed to the *RExpression* actor as arrays. This workflow is included in the demos/getting-started directory (05LinearRegression.xml), and step-by-step instructions for creating it can be found in the Getting Started Guide.

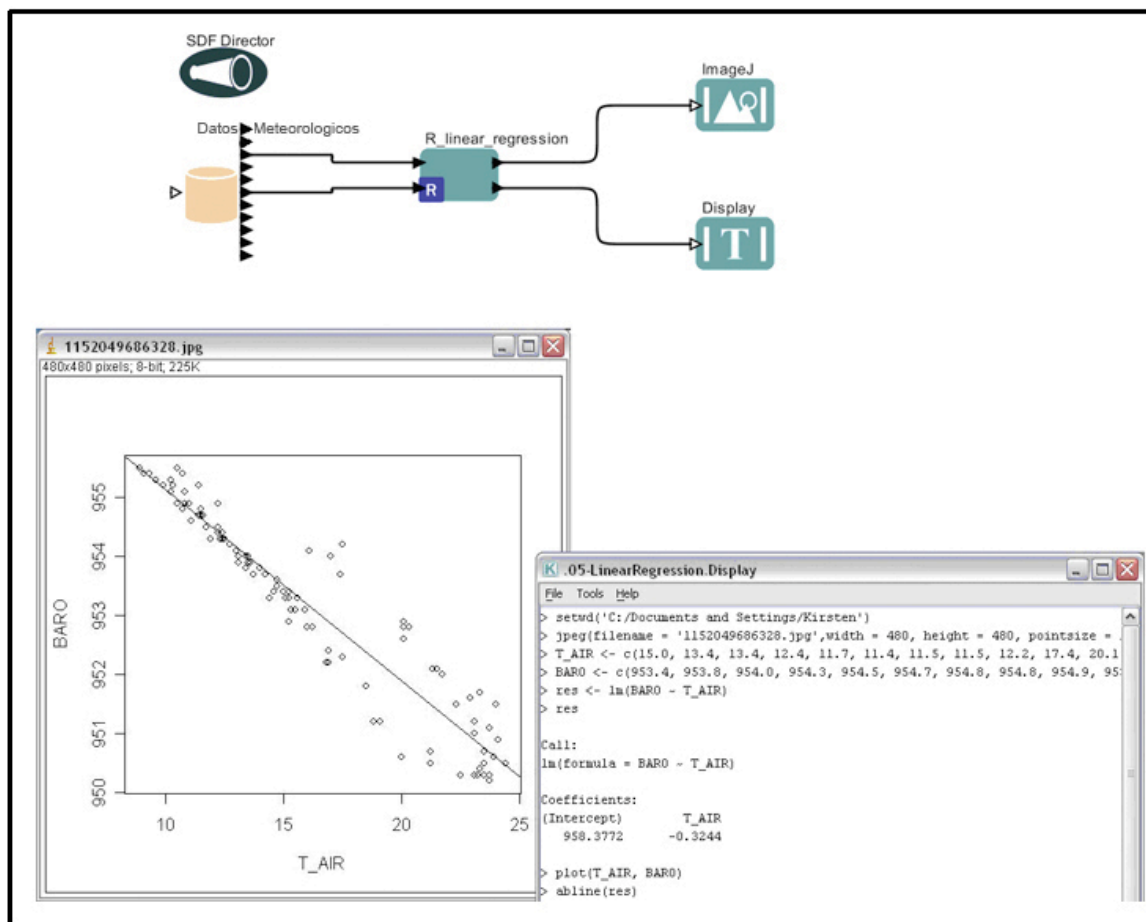
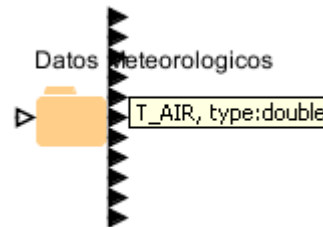

Figure 8.18: Linear Regression workflow and its output.

The left-hand window in *Figure 8.18* displays the scatter plot of Barometric pressure to Air Temperature along with a regression line. The graph shows a strong negative relationship between the two: as air temperature lowers, the Barometric pressure rises.

The right-hand window displays the Barometric Pressure and Air Temperature data used in the scatter plot. Additionally, the intercept on the Y-axis (958.38 Barometric Pressure and the slope -0.32 for the linear regression equation $y=mx+b$) is displayed.

The data set used by the workflow in is described by EML metadata, and so the *EML2Data set* actor is used to access the data. To locate the desired ports (for barometric pressure and air temperature, in this case), mouse over the data actor's ports to reveal an identifying tooltip.



The *Datos Meteorologicos* actor is configured to output the barometric pressure and air temperature data as arrays. To set this output type, select “As Column Vector” from the pull-down menu beside the *Datos Meteorologicos* actor's Data Output Format parameter (Figure 8.19) and click Commit.

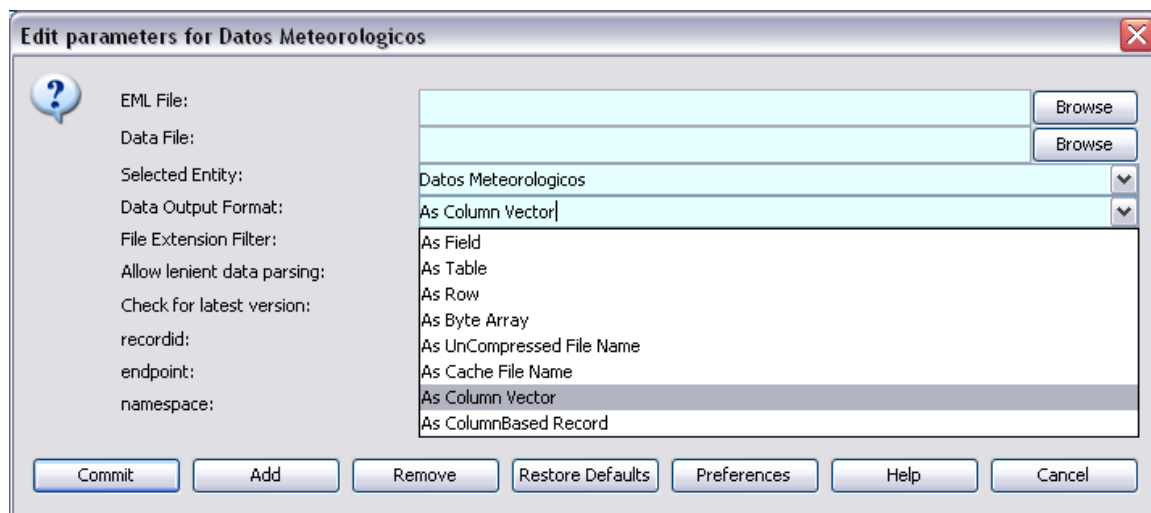

Figure 8.19: Configuring *Datos Meteorologicos* for use with the *RExpression* actor.

The R-script used by the *RExpression* actor instructs it to read the Barometric Pressure and Air Temperature data and then plot the values along with a regression line.

```
res <- lm(BARO ~ T_AIR)
res
plot(T_AIR, BARO)
abline(res)
```

Note that the user-defined input ports of the *RExpression* actor have been named “T_AIR” and “BARO” as a convenience so that they correspond to the names of the

EML2Dataset actor ports providing the data. There is no functional requirement that the input port names match the names of the output port to which they are connected.

Using Record Tokens

The *RExpression* actor can be configured to process Kepler record tokens, which is particularly useful when performing R-analyses over several columns of data in an EML dataset but not the entire table. A record token is a collection of named arrays representing the columns of a data table (e.g., $\{\text{BARO} = \{953.4, 953.8, 954.0\}, \text{RAIN} = \{2.4, 3.8, .01\}, \text{RH} = \{99, 27, 99\}\}$, where BARO, RAIN, and RH are the column names).

The workflow in *Figure 8.20* uses an *RExpression* actor and a record token to create a scatter plot matrix of a subset of the *Datos Meteorologicos* data fields: Air Temperature, Barometric Pressure, and RH.

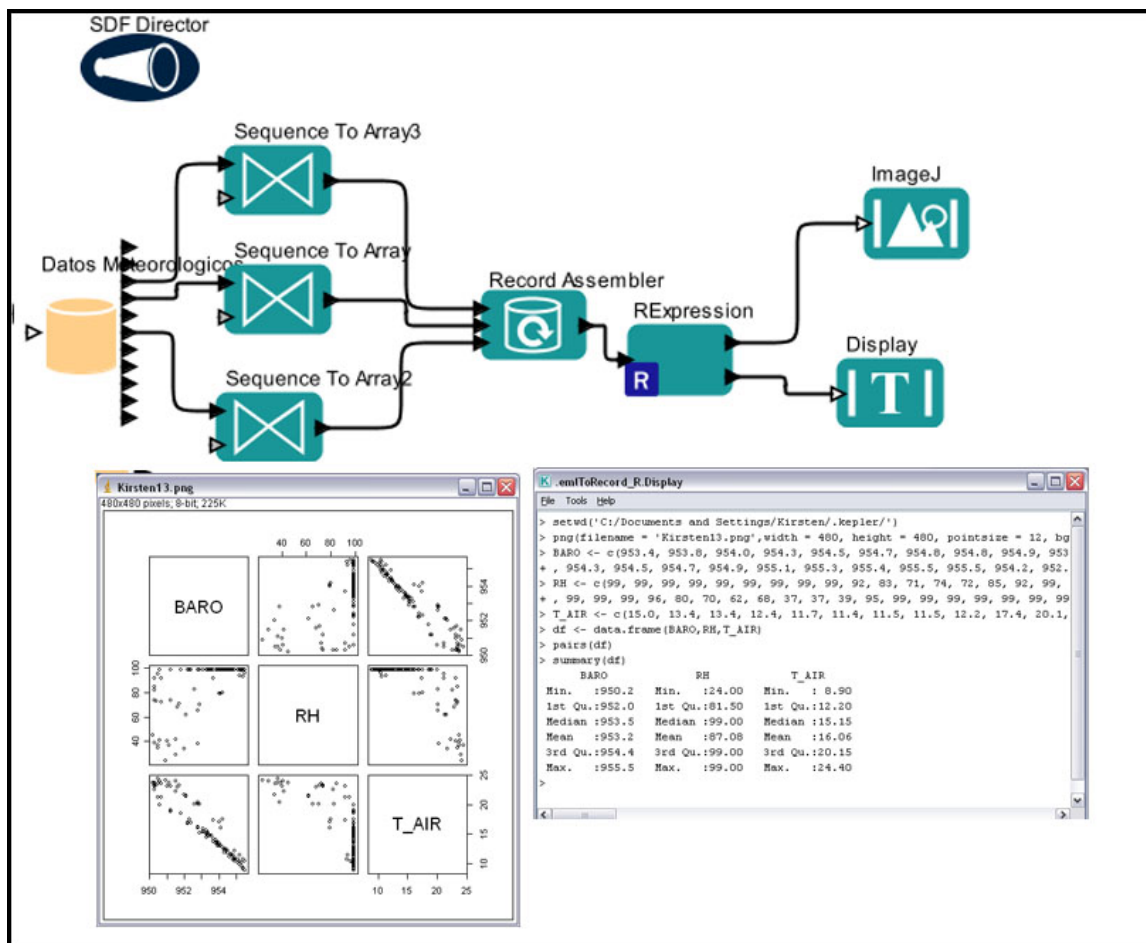

Figure 8.20: Using the *RExpression* actor with a record token.

The *Datos Meteorologicos* actor in *Figure 8.20* has been configured to output data as "Fields" (the default). Each field of data is sent to a *SequenceToArray* actor that "limits" the number of fields to 100 via the `arrayLength` parameter (set to 100). In order for

the *RecordAssembler* actor, which reads and combines the three arrays output by the *SequenceToArray* actors to produce a single record token, all of the arrays must be the same length (though not the same data type). If the arrays are not the same length, the input is ignored by the *RecordAssembler* actor. The *RecordAssembler* actor must be configured with three user-defined input ports to receive the array data.

The *RExpression* actor reads the record token and displays the scatter plot matrix and summary statistics for the three variables using the following *RExpression* script:

```
pairs(df)
summary(df)
```

Using Data Tables

The *RExpression* actor can be configured to process an entire dataset using a data table, a format that can be output by the *EML2Dataset* actor instead of individual vectors. To output a data set in table format, select "As Cache File Name" as the `Data Output Format`. Note that the output ports of the data actor automatically reconfigure themselves appropriately; the name of the data table is output via the port named `CacheLocalFileName`.

The workflow in *Figure 8.21* uses a data table and an *RExpression* actor to create a scatter plot matrix of the entire *Datos Meteorologicos* dataset. The data table is also displayed in the text display window.

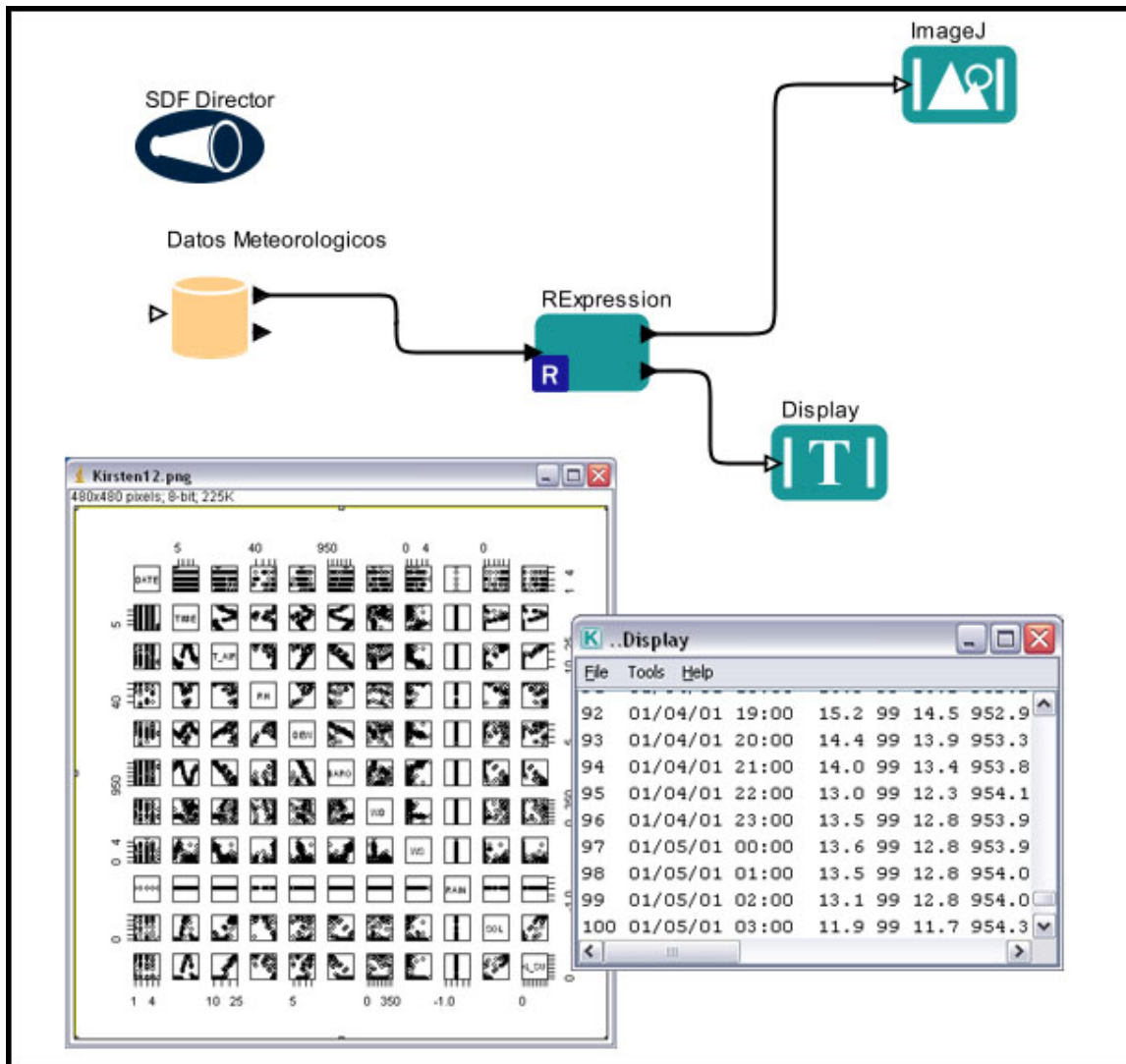

Figure 8.21: The *RExpression* actor using a data table. The data output format of the *Datos Meteorologicos* actor has been set to "As cache file name".

The *RExpression* actor uses the following R-script to read the data table and create a pairs graph:

```
datafile <- infile
df <- read.table(datafile, sep=",", header=TRUE)
pairs(df)
df
```

An alternative method for loading tabular data from the EML actor into the *RExpression* actor is to use the "As Column Based Vector" output format for the EML actor. When the actor is configured with this setting, a single "record" output port is created. When the record port is connected to an *RExpression* input port, an R-dataframe structure is created. This approach is advantageous because it can make use of the built-in data selection mechanism (i.e., the Query Builder) of the EML actor. Additionally, it insulates

the *RExpression* script from dealing directly with file parsing configuration details like header lines and record delimiters. See the Appendix B for an example of this method.

8.2.4.3 Using Excel Data (i.e., Non-EML data) with the RExpression Actor

Although simple comma- or tab-delimited data sets (e.g., Excel files exported as text) are less versatile than EML-described data sets, Kepler has a special R actor designed to process with this type of source: the *ReadTable* actor. The *ReadTable* actor reads a text-based data file on the local file system and outputs the data as a data frame, a format that can be digested by other R actors.

To use the *ReadTable* actor, data must be in a 'spreadsheet-like' tabular format, where each line of the data file contains one row of values, separated by a 'separator' delimiter (tab, comma, space, etc). Saving an Excel spreadsheet as a text file creates such a data file (with a tab separator).

The "mollusc_abundance.txt" dataset, found in the R module demo directory is an example of a simple tabular data set that contains occurrence data for several species of mollusc collected in 2000. The workflow in *Figure 8.22* uses the *ReadTable* actor to "translate" this data set into a data frame that is then passed to an *RExpression* actor that extracts each species name from the dataset and then calculates count averages for each of the species. The workflow outputs a plot of the averages. The full workflow (ReadTable.xml) can be found in the R module demo directory.

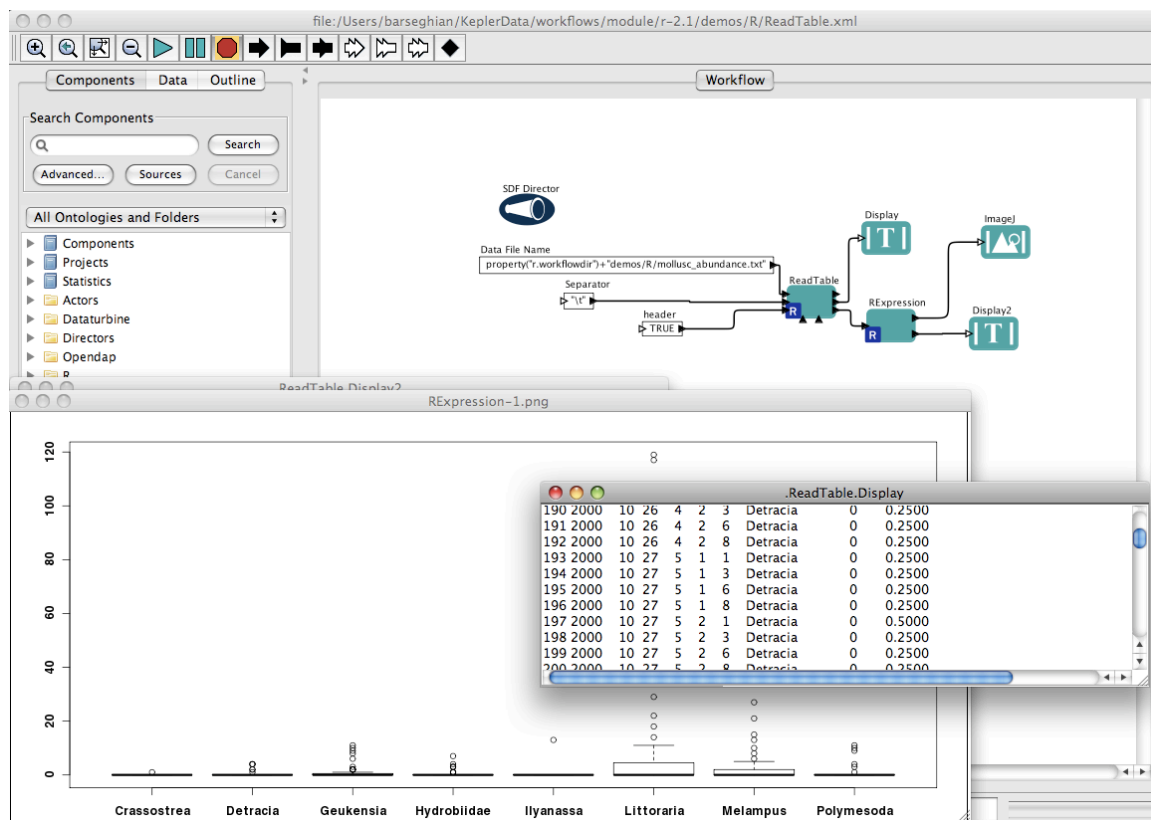

Figure 8.22: Using the *ReadTable* actor to translate a local, tab-delimited data set into a data frame format, which can be processed by other R actors.

The *ReadTable* actor is itself an R actor, and double-clicking the actor reveals the R-script in the actor parameters (*Figure 8.23*).

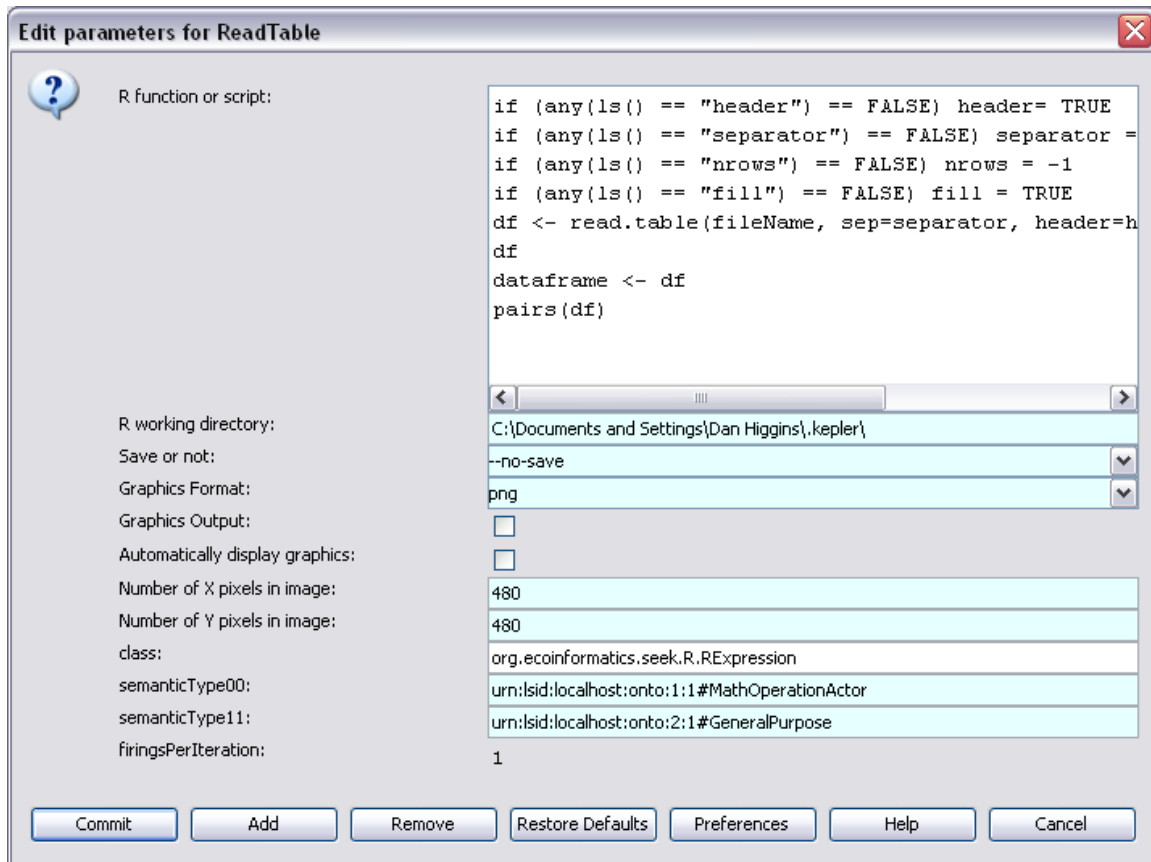

Figure 8.23: The *ReadTable* actor parameters.

By default, the actor assumes that the first row of the data file contains column names (e.g., "Date", "Occurrence", etc). The default separator is any white space (e.g., spaces or tabs). Use the *ReadTable* actor's `header` and `separator` ports to specify other behaviors (e.g., a comma "," as the separator, or "FALSE" to indicate that the data set does not contain header information. Often, all input ports other than the file name can be left unconnected. An additional output port (called `dataframe`) has been added to the *ReadTable* actor to pass the data frame to the downstream *RExpression* actor. For more information, please see the R documentation for [read.table](#).

8.3 Statistical Computing: MATLAB

Kepler's *MATLABExpression* actor runs a MATLAB function or script and outputs the result of the evaluated script. MATLAB ("MATrix LABoratory") is a high-level technical computing language and interactive environment for algorithm development, data visualization, data analysis, and numeric computation.⁴³ The application is available through The Mathworks, <http://www.mathworks.com>. The *MatlabExpression* actor *will not* run unless MATLAB is installed on the local system. Please refer to the Mathworks site for information about obtaining and installing MATLAB.

The *MATLABExpression* actor works much like the *RExpression* actor: specify the desired MATLAB expression and configure the appropriate input and output ports. The expression may include references to the input port names, current time (*time*), and a count of the firing (*iteration*). To refer to parameters in scope, use *\$name* or *\${name}* within the expression.

NOTE: You must set an environment variable to the MATLAB libraries directory before running Kepler. The following examples are for MATLAB R2007b installed in a common location:

Mac:

In a terminal window:

```
export DYLD_LIBRARY_PATH=/Applications/MATLAB_R2007b/bin/maci
kepler
```

Windows:

Start->Run

cmd

```
set PATH=%PATH%;c:\Program Files\MATLAB\R2007b\bin\win32
```

```
kepler.bat
```

Linux:

In a terminal window:

```
export LD_LIBRARY_PATH=/usr/local/matlab/bin/glnx86
kepler
```

Once your system is configured properly, you can begin to build and run workflows using the *MatlabExpression* actor. The workflow in *Figure 8.24* uses a *MATLABExpression* actor to invoke a command in MATLAB: the function "surf" (which renders a matrix as a surface plot) on the matrix input.

⁴³ Mathworks website, <http://www.mathworks.com/products/matlab/description1.html>

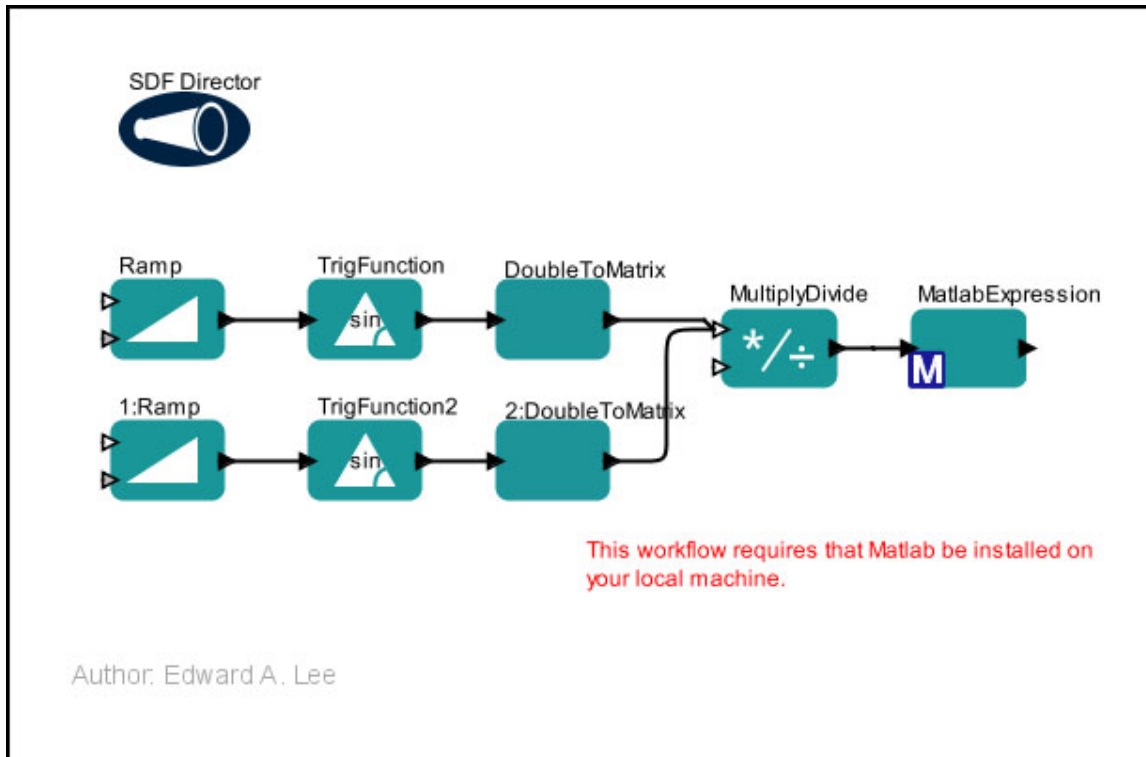

Figure 8.24: Using the *MATLABExpression* actor. This workflow can be found under `demos/MATLAB/MatlabExpression.xml`.

The 'surf' function is specified in the value of the *MatlabExpression* actor's expression parameter (*Figure 8.25*). Note that the name of the actor's input port is "input," which is referenced in the expression value as well. The actor's other two parameters, `get1x1asScalars` and `getIntegerMatrices`, control data conversion. `get1x1asScalars` specifies that all 1x1 matrix results be converted to scalar tokens (the default). Select the `getIntegerMatrices` parameter to check all double-valued matrix results and return an `IntMatrixToken` if all elements represent integers. This setting is off by default for performance reasons.

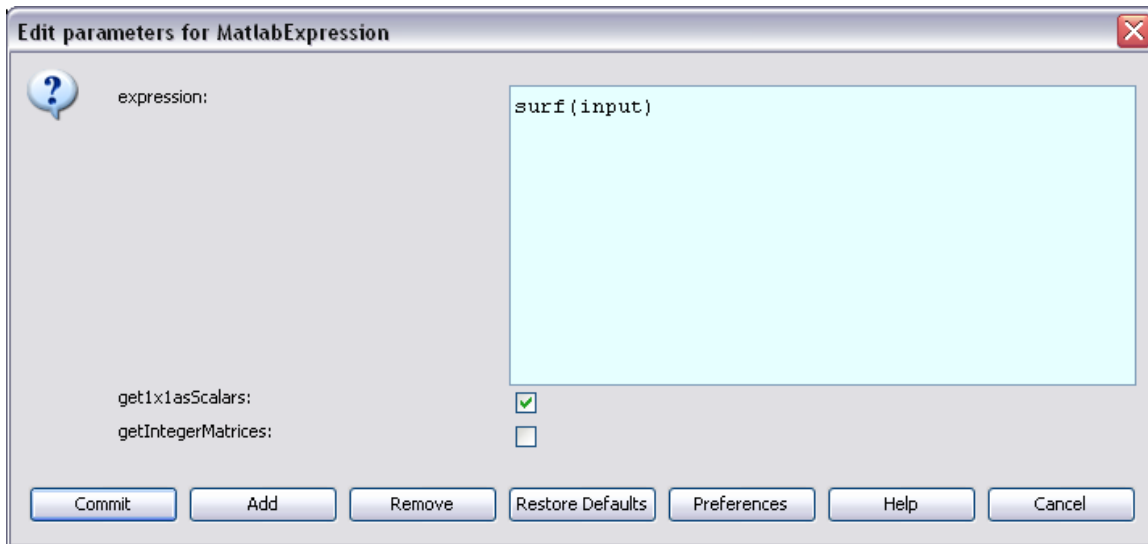

Figure 8.25: Parameters of the *MatlabExpression* actor.

To augment the search path used by the MATLAB engine to locate files, set a user-defined parameter named `packageDirectories` containing a comma-separated list of paths to be prepended to the MATLAB engine search path. Paths can be relative to the directory in which Kepler was started, or any directory listed in the current classpath (in that order, first match wins). After evaluation, the previous search path is restored. Note: to add a new actor parameter, double-click the *MatlabExpression* actor and click the Add button.

Add a `_debugging` parameter to send debug statements to stdout. An integer value of 1 will return statements from the MATLAB Engine, a value of 2 returns debug statements from both the MATLAB Engine and the Kepler JNI, and a value of 0, or the absence of the parameter, restores the debug behavior to the default setting (off).

8.4 Image Manipulation: ImageJ

The Kepler library contains two actors (*ImageJ* and *IJMacro*) designed to interface with ImageJ, a public domain Java image processing program inspired by [NIH Image](http://rsb.info.nih.gov/ij/) for the Macintosh. ImageJ can display, edit, analyze, process, save and print 8-bit, 16-bit and 32-bit images (Figure 8.26). It can read many image formats including TIFF, GIF, JPEG, BMP, DICOM, FITS and "raw". It supports "stacks", a series of images that share a single window. It is multithreaded, so time-consuming operations such as image file reading can be performed in parallel with other operations.⁴⁴

⁴⁴ Rasband, W.S., ImageJ, U. S. National Institutes of Health, Bethesda, Maryland, USA, <http://rsb.info.nih.gov/ij/>, 1997-2007.

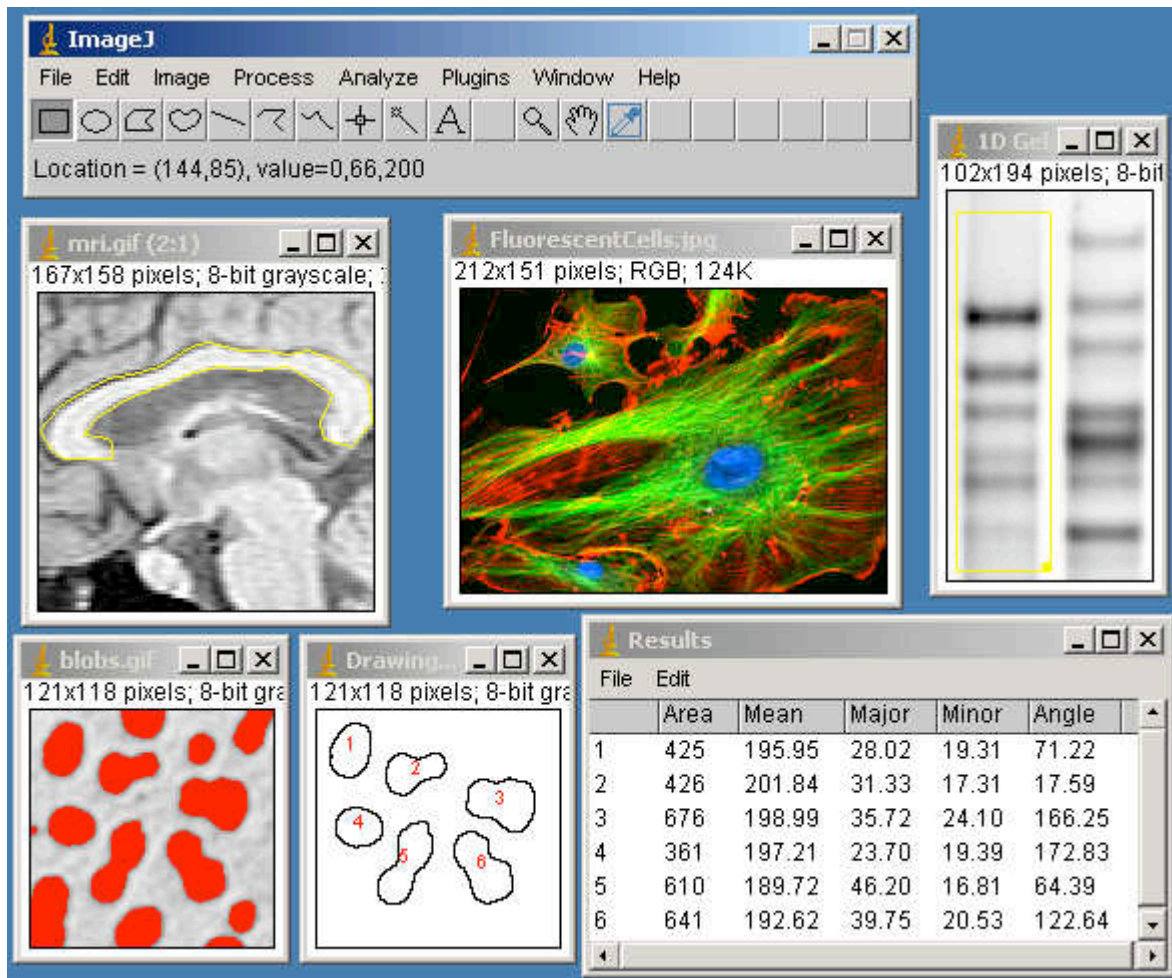

Figure 8.26: ImageJ toolbar (upper left) and examples of image data. This image is from the ImageJ Web site, <http://rsb.info.nih.gov/ij/index.html>

Kepler's *ImageJ* actor reads an image file name and opens and displays the image along with the ImageJ toolbar containing image-processing options, which can be used to process the image. The *IJMacro* actor runs ImageJ macros, which are used to display, edit, analyze, process, save, and print a wide variety of image formats. In this section, we will look more closely at these actors and at how the ImageJ application can be used to perform some useful processes such as rescaling, clipping, and adjusting color balance. For an in-depth look into all of the capabilities of ImageJ, please see the ImageJ documentation.

8.4.1 Intro to ImageJ and the ImageJ Actor

The *ImageJ* actor is used to display and/or manipulate a wide variety of image formats: TIFF (uncompressed), PNG, GIF, JPEG, DICOM, BMP, PGM, FITS format, or ImageJ

and NIH Image lookup tables (with ".lut" extension). Additional file formats are supported via plugins installed in the Import submenu (File > Import...).

The simple (one actor!) workflow in *Figure 8.27* demonstrates how the *ImageJ* actor is used to open the Kepler logo (a PNG file specified by the *ImageJ* actor's *fileOrURL* parameter) in a display window. The ImageJ toolbar opens as well, and can be used to manipulate the image in a number of ways. The actor can also receive the URL of an image via its *input* port, which is useful when displaying the graphical output of a workflow, for example.

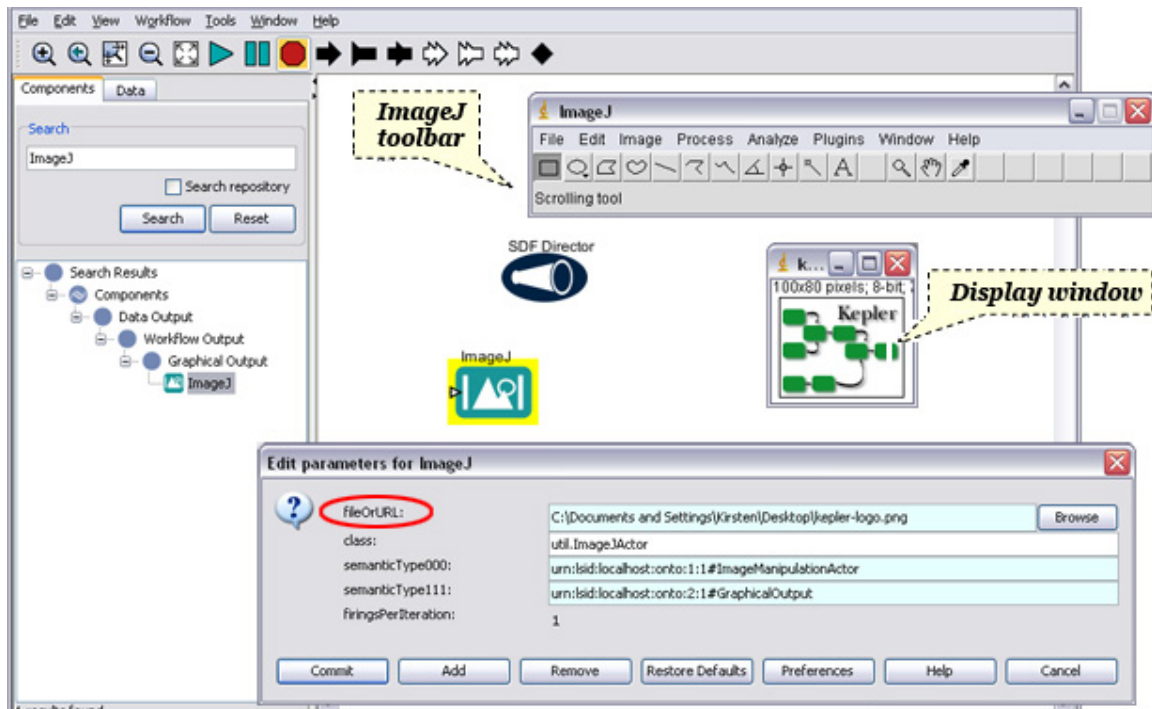

Figure 8.27: Opening an image with the *ImageJ* actor. Specify the path of the image to open in the *ImageJ* parameters (shown above) or via the actor's input port.

8.4.1.1 Rescaling Images

Once an image has been opened by ImageJ, you can use the ImageJ tools and menu options to process and save the image as desired. To rescale an image, for example, select Scale from the drop-down Image menu in the ImageJ toolbar (*Figure 8.28*).

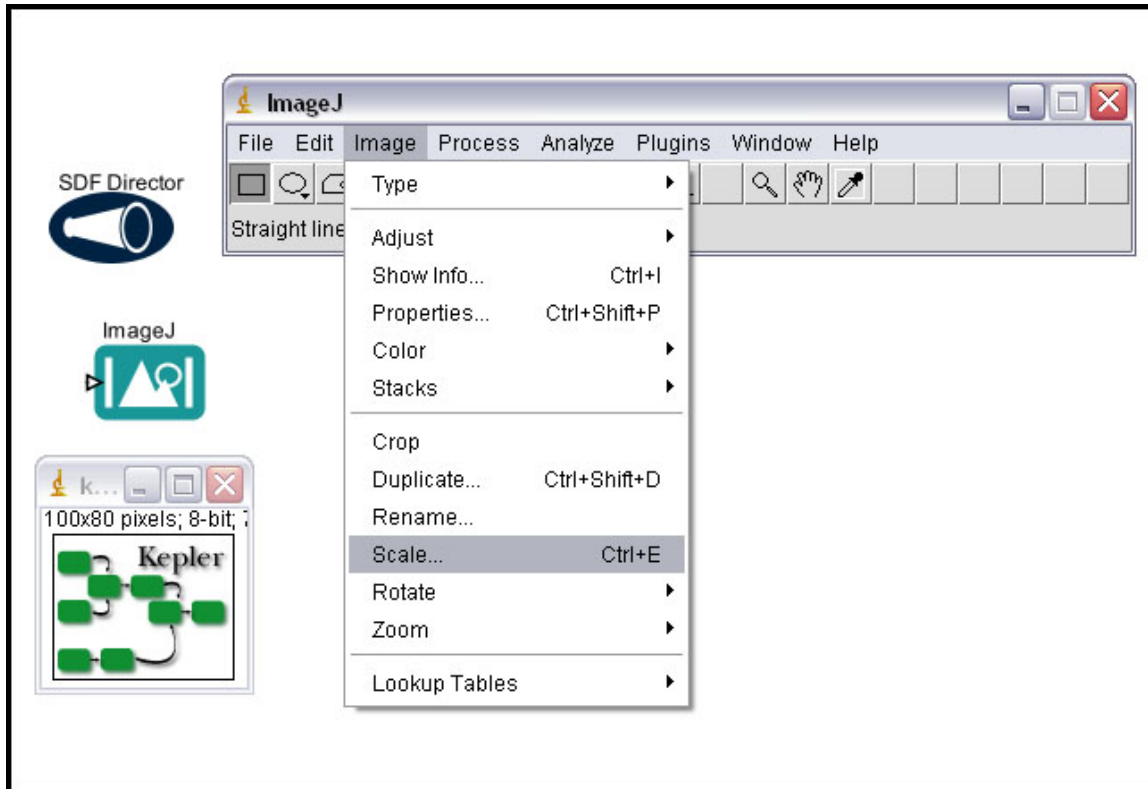

Figure 8.28: Scaling an image using the ImageJ Scale menu item.

A dialog box allows users to select scaling settings (*Figure 8.29*). Images can be scaled by a factor (.05-25) or using specified dimensions in the Width and Height fields. Check `Interpolate` to scale using bilinear interpolation. Select `Create New Window` to open the scaled image in a new display window. The `Fill with Background Color` option applies when the new image is opened in the original display window.

To rescale multiple images, you may wish to use the *IJMacro* actor with an appropriate macro. We will look at an example of using the *IJMacro* actor in Section 8.4.2.

Figure 8.29: ImageJ scaling settings

8.4.1.2 Clipping Images

Another common way to manipulate images is to clip them, i.e., select a fragment of the image that is of interest. To select only South America from a map of the world, for example, use one of the seven ImageJ selection tools available in the toolbar (*Figure 8.30*). The selection will be highlighted with a yellow border.

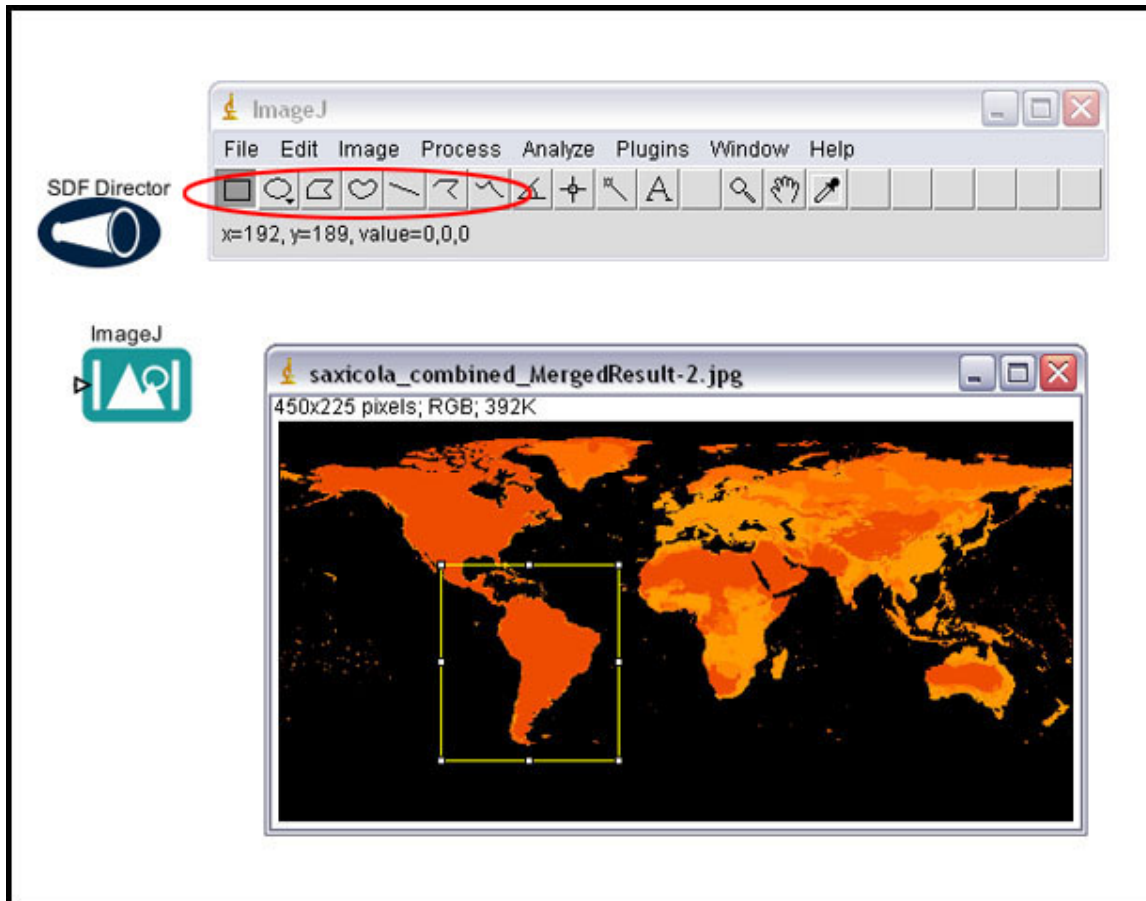

Figure 8.30: Using an ImageJ selection tool to select a portion of a displayed image. ImageJ has a number of selection tools (highlighted with red oval).

Once a selection has been made, copy it to the system clipboard with the `Copy to System` menu item (*Figure 8.31*). This command copies the contents of the current image selection to the system clipboard. If there is no selection, the command copies the entire active image.

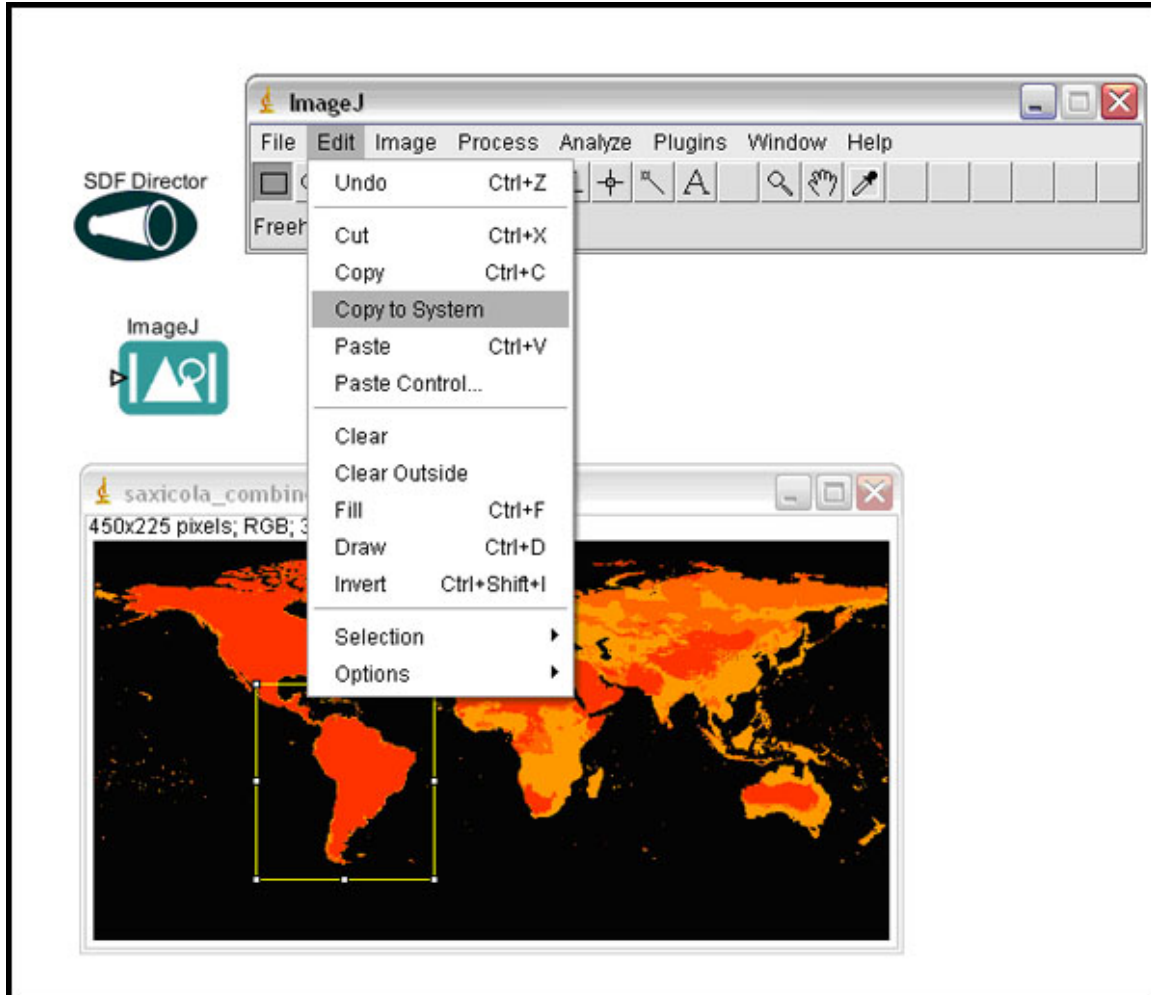

Figure 8.31: Copying a selection to the system clipboard using the ImageJ toolbar.

Note that the ImageJ toolbar has a context-sensitive status area (*Figure 8.32*). When rolling over an image, for example, the x- and y-position of the cursor is displayed along with other relevant information, such as the cell value (for asc grid files) or the RGB color value (for jpg files, etc).

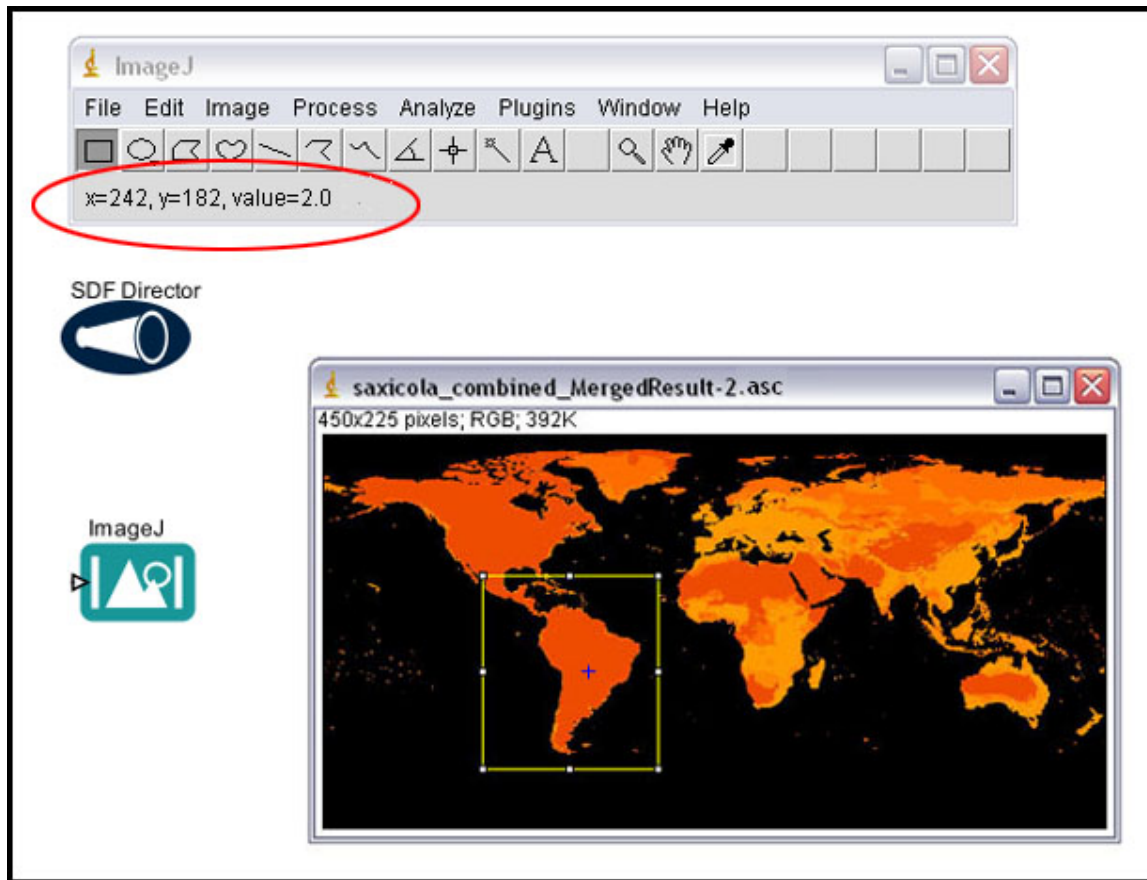

Figure 8.32: The ImageJ status area is highlighted with a red oval. The x and y position of the cursor is displayed along with the cell value (the displayed file is an asc grid file).

8.4.1.3 Adjusting Image Color and Brightness

To adjust the color, brightness, contrast, etc of an image, use the options in the ImageJ `Image > Adjust...` menu (Figure 8.33). The Brightness and Contrast dialog window that opens when that menu item is selected contains four sliders. *Minimum* and *Maximum* control the lower and upper limits of the display range. *Brightness* increases or decreases image brightness by moving the display range. *Contrast* increases or decreases contrast by varying the width of the display range. The narrower the display range, the higher the contrast. Use the Color Balance menu item to make adjustments to the brightness and contrast of a single color of a standard RGB image.⁴⁵

The ImageJ documentation has comprehensive information about all of the many image adjustments (brightness, contrast, size, threshold, scale, crop, etc) that can be made with ImageJ. Please see <http://rsb.info.nih.gov/ij/> for more information.

⁴⁵ See <http://rsb.info.nih.gov/ij/>

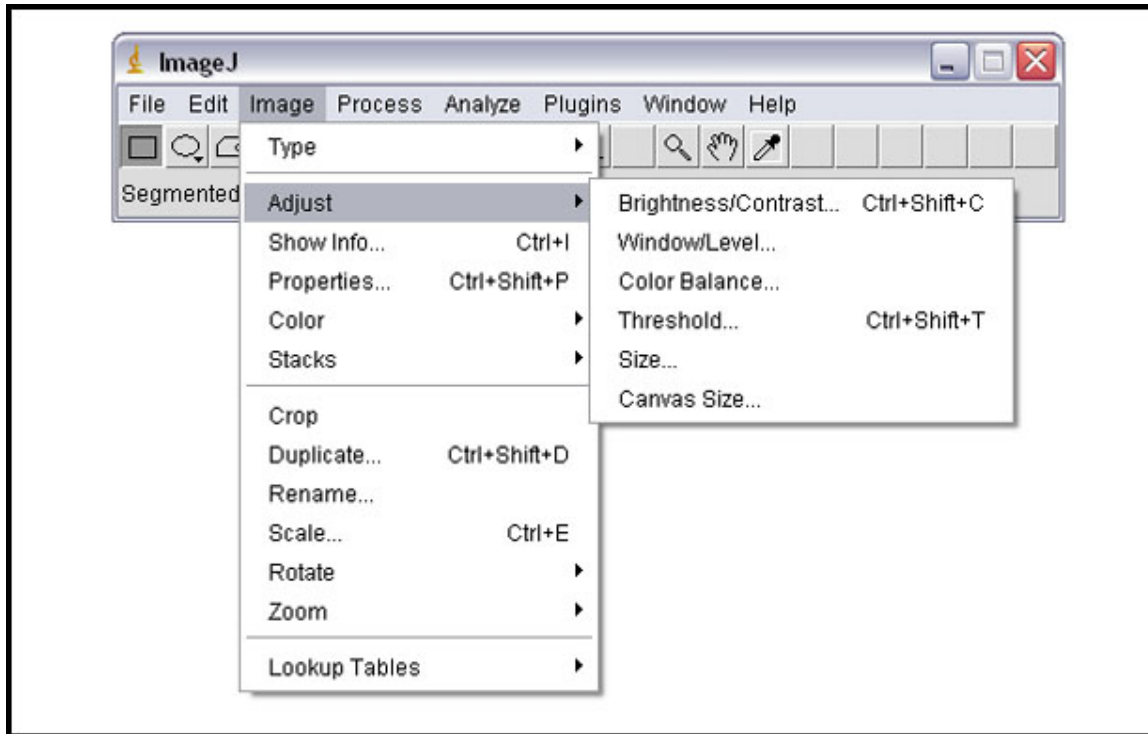

Figure 8.33: Adjusting the contrast, brightness, and color of an image.

8.4.1.4 Selecting a Color Palette for ASC Grid Images

The image in *Figure 8.32* was generated by one of Kepler's Ecological Niche Modeling workflows (GARP_SingleSpecies_BestRuleSet-IV.xml), which displays an ASC grid file that represents the possible distribution of a species. For each cell in the ASC grid, the workflow calculates the likelihood of a species being present. The grid file is displayed using the "fire" palette, which assigns brighter colors to higher pixel values (in general, cells where there is a higher likelihood of species presence have higher values). To change the look of the map (perhaps to prepare it for a black and white publication or to find colors that match the look and feel of a presentation), simply select a new palette under the Image > Lookup Tables... menu (*Figure 8.34*).

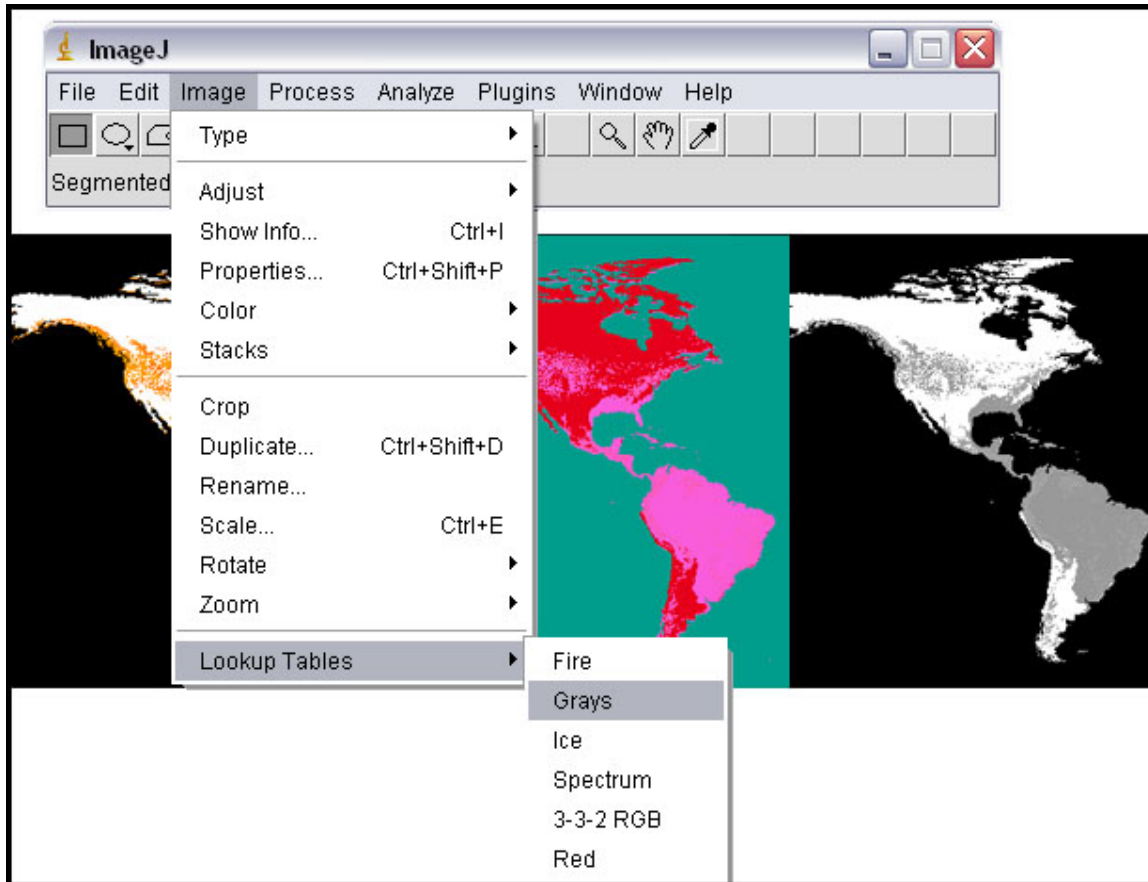

Figure 8.34: Using the Image > Lookup Table menu to customize the look and feel of a displayed ASC grid file.

The selected color palette can be further customized using the Brightness and Contrast settings.

8.4.2 The IJMacro Actor

In addition to opening and displaying images, the *IJMacro* actor can be programmed to access all of the powerful functionality of ImageJ using a macro--a simple program that automates a series of ImageJ commands. Macros are written in the ImageJ Macro Language, though in most cases users do not have to learn it. This is because (1) ImageJ already has a large library of Macros that can be cut and pasted into the *IJMacro* actor and (2) ImageJ macros can be easily created using the Recorder, accessed under Plugins > Macros > Record... menu.

The workflow in *Figure 8.35* uses an IJMacro to open an ASC grid file, adjust its brightness and contrast settings, and assign a color palette.

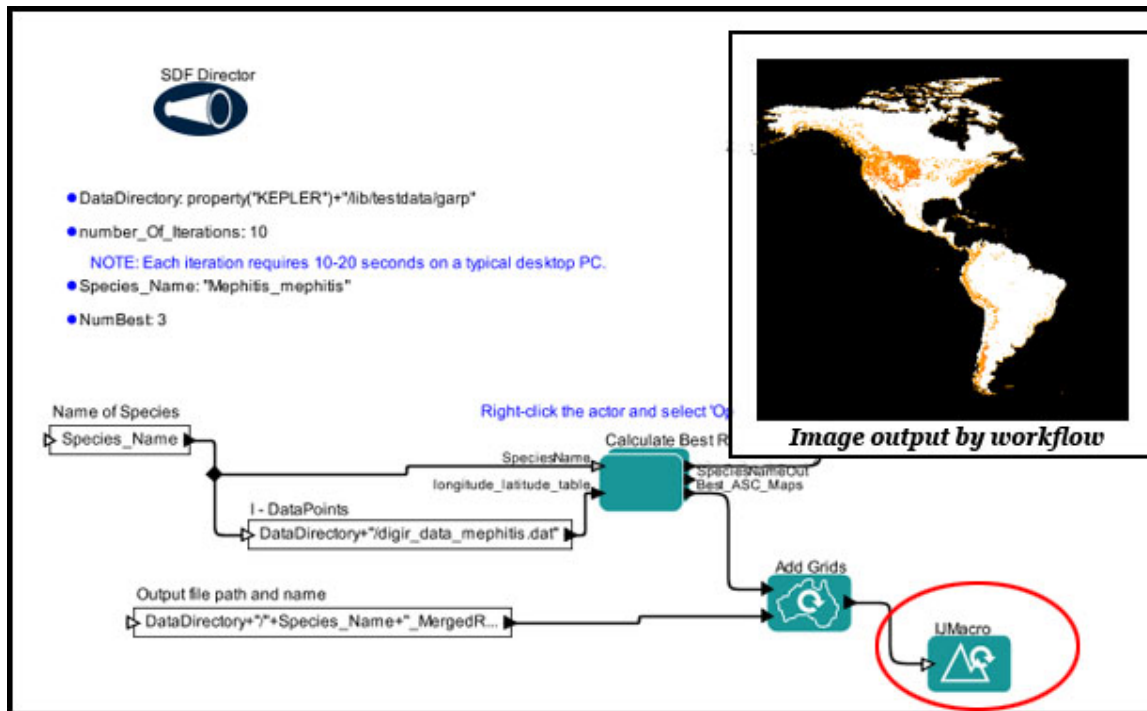

Figure 8.35: An Ecological Niche Modeling workflow (GARP_SingleSpecies_BestRuleSet-IV.xml) that uses an *IJMacro* actor to customize the graphical display of the workflow output.

Note that ASC grid files cannot be opened natively with ImageJ. To open an ASC file, one must evoke the ASC TextReader plug-in, which can understand the format. The Macro used by the *IJMacro* actor in the ENM workflow calls the ASC reader plug-in as well as a number of other commands used to adjust the Brightness/Contrast settings and select a color palette (Figure 8.36).

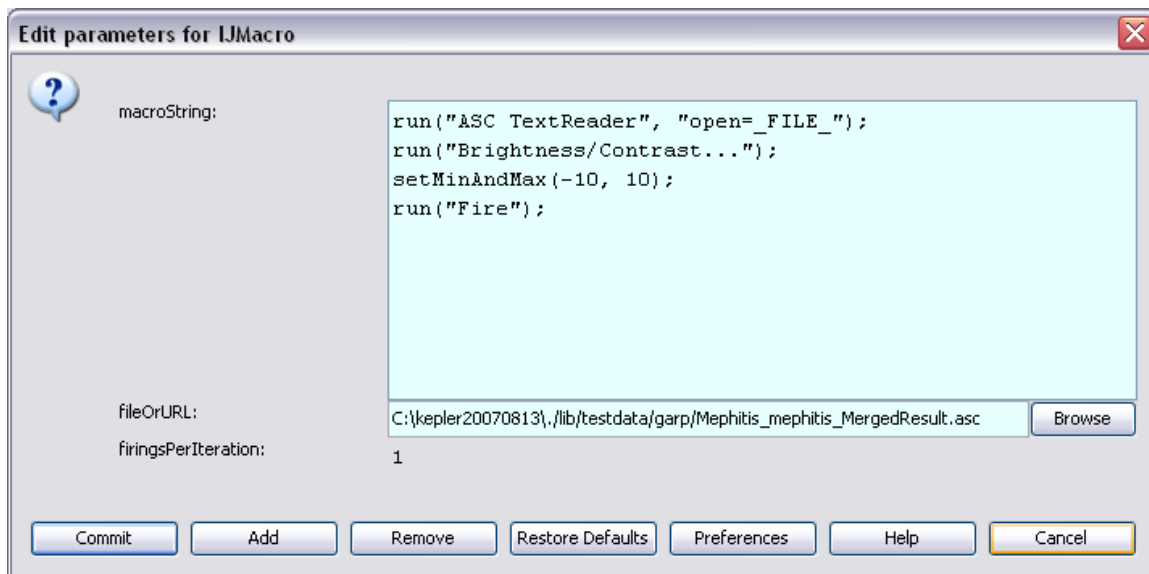

Figure 8.36: The parameters of the *IJMacro* actor.

To create a Macro like the one used in *Figure 8.35*, select Macros and then Record from the Plugins menu. A macro record window opens (*Figure 8.37*).

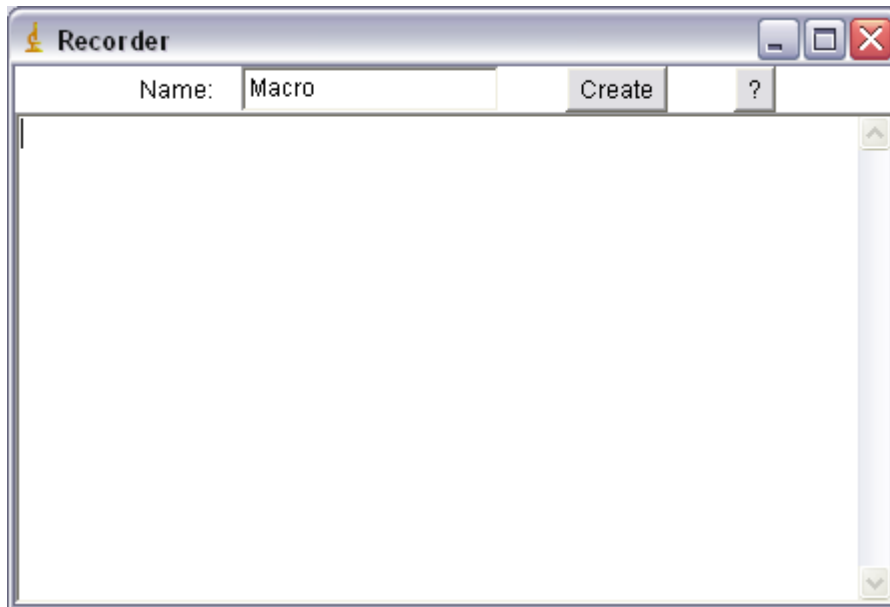

Figure 8.37: The ImageJ macro recorder.

Once the recorder is open, simply perform the operations the macro should perform. For example, to set the Contrast/Brightness of an image, select Adjust > Brightness/Contrast from the Image menu. The action is "recorded" in the macro record window in Macro Language: `run("Brightness/Contrast...");` Any adjustments made to the settings will be recorded as well. Once the macro has been "designed by hand" and recorded, it can be cut and pasted into the `macroString` parameter of the `IJMacro` actor.

For a library of over 200 ready-made ImageJ macros, see the ImageJ macro library at <http://rsb.info.nih.gov/ij/macros/>.

8.5 Spatial Data: Geographic Information Systems (GIS)

The Kepler component library contains a number of GIS actors, which are used to capture, manage, analyze, and display all forms of geographically referenced information. From actors designed to interface with the Geospatial Data Abstraction Library (GDAL, a translator library for raster geospatial data formats), to actors that can display geographic information encoded as Geography Markup Language (GML) or ESRI shape files, Kepler provides support for a wide variety of geographic formats and systems.

8.5.1 Masking a Geographical Area with the ConvexHull and CVToRaster Actors

Masks, which "black out" areas of a map that are not of interest, can be used to isolate a specific geographic region (*Figure 8.38*). Kepler's environmental niche modeling (ENM) workflows use masks to help generate species' absence points from a defined area (only the area where species occurrences have been noted), for example. For more information about Kepler's ENM workflows, including in-depth instructions for creating a mask file for ENM purposes, please see the Guide to ENM.

The Kepler library contains several actors that are particularly useful for creating mask files: *ConvexHull* and *CVHullToRaster*. The *ConvexHull* actor constructs a convex hull (the smallest polygon that contains a given set of geographic points) for an area of interest. The convex hull is derived from a set of input data points, which consist of a longitude and latitude value (see KeplerData/workflows/module/outreach-2.1/data/garp/DataPoints.txt for an example). The *CVHullToRaster* actor receives a convex hull and creates and saves a mask file from it. Points outside the convex hull are assigned a value of "NO_DATA".

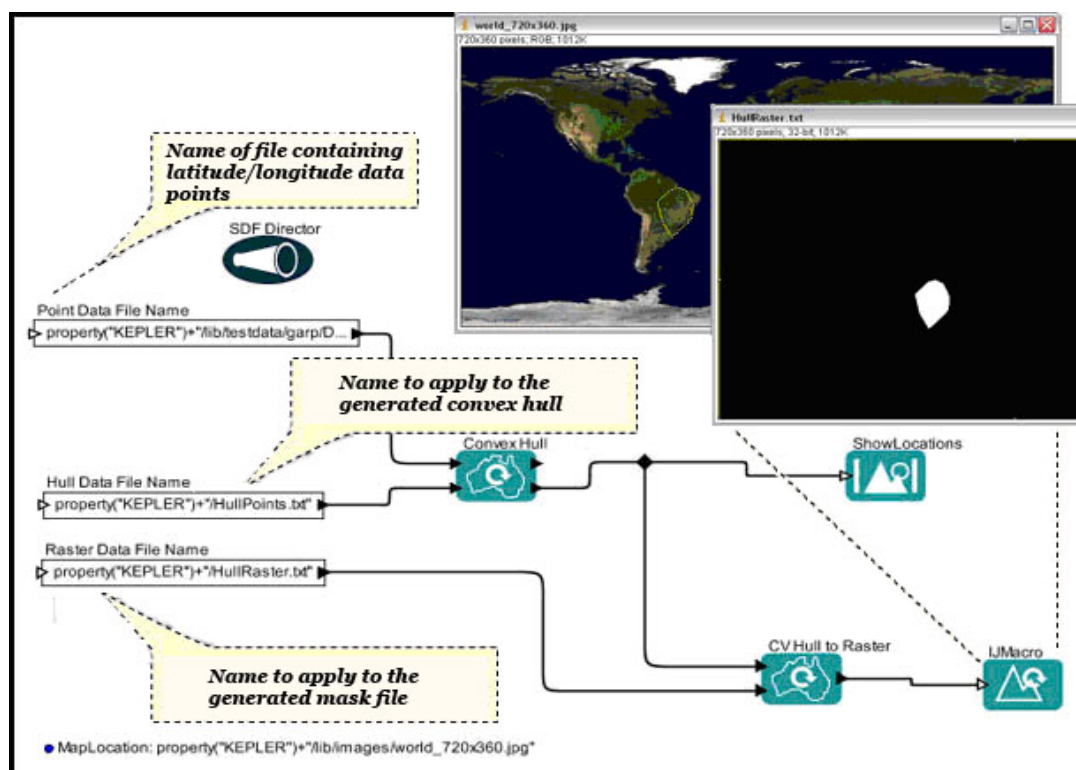

Figure 8.38: Using *ConvexHull* and *CVHullToRaster* actors to generate a mask file ("HullRaster.txt").

The name and location of the convex hull file are passed to the *CVHullToRaster* actor, which creates and saves a mask file with the correct resolution and extent. The resolution

(cellsize) and extent (numrows and numcols) are specified by the actor's parameters (Figure 8.39).

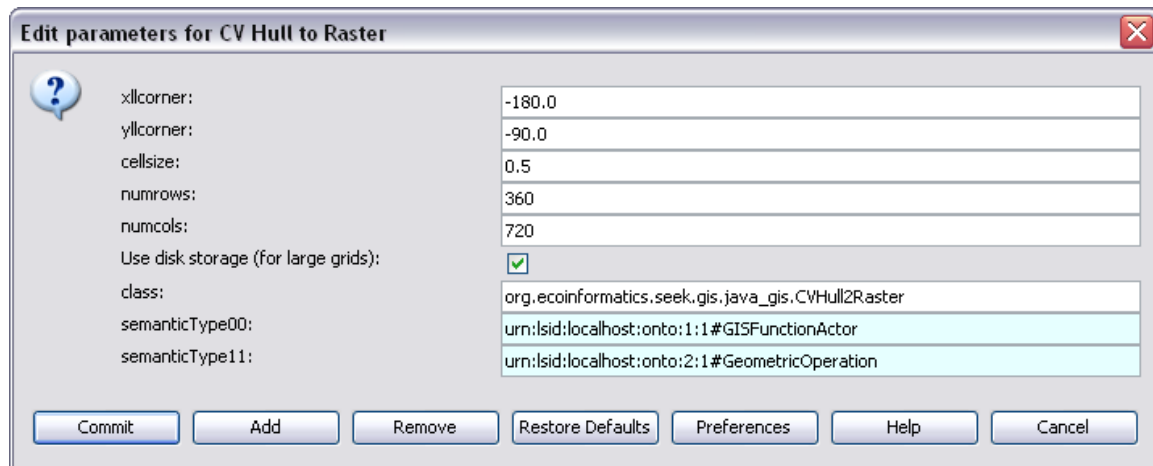

Figure 8.39: The parameters of the *CV Hull to Raster* actor.

The *CVHullToRaster* actor writes the mask file to the location specified via the `rasterFileName` port and outputs the name of the mask file.

8.5.2 Geospatial Data Abstraction Library (GDAL) Actors

The Geospatial Data Abstraction Library (GDAL) is an open source software package designed to read, write, and manipulate a wide variety of Geographical Information System (GIS) raster grid files.⁴⁶ Kepler has several very useful actors that use the GDAL library to perform geospatial file transformations: the *GDALFormatTranslator* actor reads a geospatial raster file and translates it to a specified format (e.g., JPEG, AAIGrid, etc); the *GDALWarpAndProjection* actor "stretches" or "warps" a geospatial raster file (e.g., a digital elevation model) from one cartographic projection to another.

Because working with high-resolution geospatial raster files can be resource-intensive and time consuming, Kepler's GDAL actors check the Kepler file cache to see if the transformed file already exists (from a previous workflow iteration, for example) before performing a translation.

The workflow (Figure 8.40) is designed to download a set of topographical data for South America (Hydro1k data, a dataset developed by the U.S. Geological Survey's EROS Data Center) via the Kepler EarthGrid. If the data have already been downloaded, the workflow will access them from a local cache. Kepler's GDAL actors are then used to transform the data: first to change the map projection and then the format.

⁴⁶ GDAL website, <http://www.gdal.org/index.html>

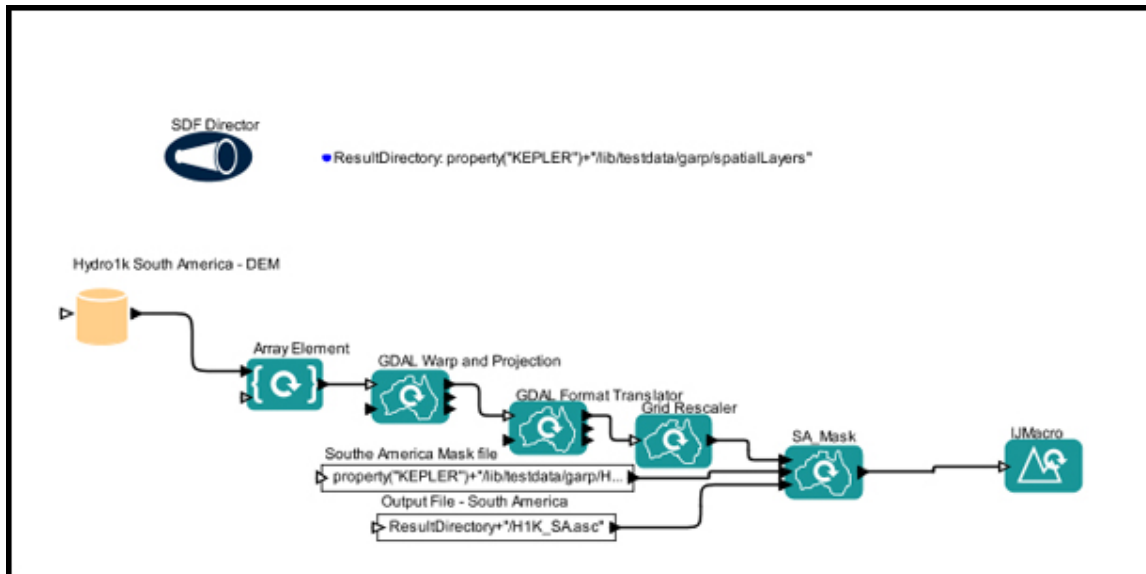

Figure 8.40: Using the GDAL actors to transform geospatial data. Note that the initial download of the Hydro1k data may take as long as 30 minutes with a reasonably fast PC.

Once the Hydro1k data is downloaded to the cache, the data are extracted from their zip file. The *Hydro1k South America DEM* actor's `DataOutputFormat` parameter (Figure 8.41) instructs the actor to unzip the downloaded data into the Kepler cache and output the file name of the dataset (actually an array of file names: the file name of the raw data as well as the file names of the associated meta data files). An *ArrayElement* actor reads the array of file names and extracts the first element, which is the name of the raw dataset. The name of the raw data is then passed to downstream actors for further transformations.

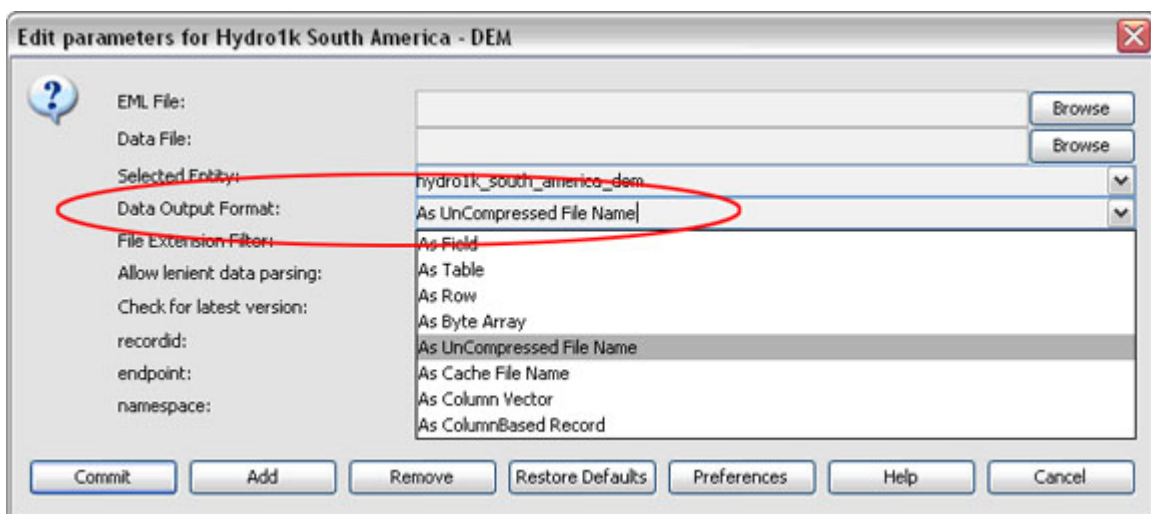

Figure 8.41: The parameters for the *Hydro1k South American –DEM* actor. Selecting "As UnCompressed File Name" as the value of the `Data Output Format` parameter instructs the actor to unzip the dataset into the Kepler cache.

The Hydro1k data use a Lambert Azimuthal Equal Area coordinate system projection (for information about the projection, see the dataset's meta data: right-click the data actor and

select Get Metadata). The *GDALWarpAndProjection* actor converts this projection to one that uses a latitude/longitude system. The input and output projection formats are specified by the actor's parameters (*Figure 8.42*). The formats must be of a form used by the GDAL Warp utility (a Lambert Azimuthal Equal Area Projection could be specified as `+proj=laea+lat_0=45+long_0=-100+x_0=0+y_0=0`, for example). For more information about supported formats, see www.remotesensing.org/geotiff/proj_list/.

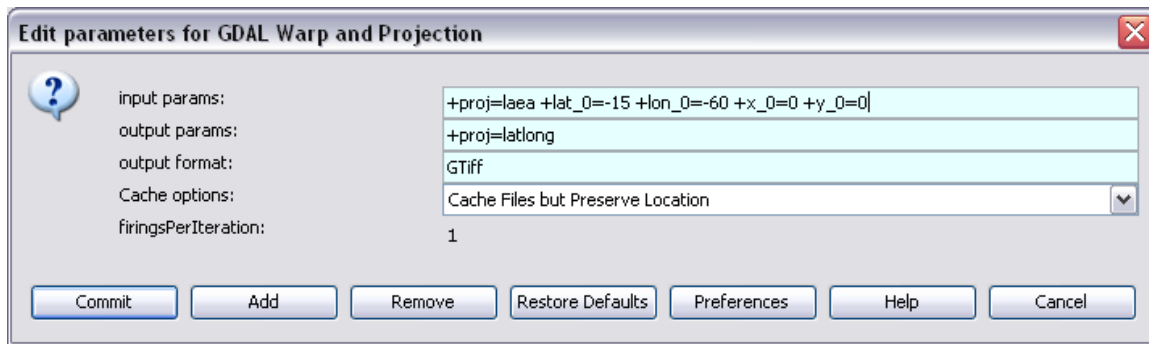

Figure 8.42: The parameters of the *GDALWarpAndProjection* actor.

Once the projection has been updated, a *GDALFormatTranslator* actor converts the raster format (GeoTiff) to a new format (ASC raster grid). Available formats are listed in a drop-down menu (AAIGrid, DTED, PNG, JPEG, MEM, GIF, XPM, BMP, PCIDSK, PNM, ENVI, ESRI, PCI, MFF, MFF2, BT, FIT, USGSDEM) in the actor parameters (*Figure 8.43*). The actor's *Cache options* parameter specifies whether the output should be copied to the cache ("Copy files to cache"), copied to the cache as well as the directory where the input raster is stored ("Cache files but preserve location"), or not cached ("No caching"). If "No caching" is selected, the actor will not cache the translated file and will ignore all previously stored cache items. Select this option to force the actor to perform a translation even if the input file was previously translated and cached.

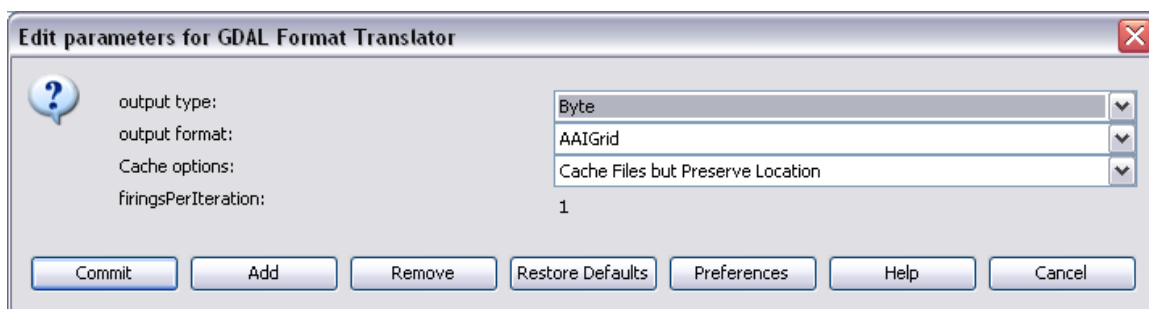

Figure 8.43: The parameters of the *GDALFormatTranslator* actor.

After the map has been translated, it is rescaled and masked (so that only continental data is displayed). The *GridRescaler* actor sets the x and y values for the lower left corner of the output grid, the cell size, and the number of rows and columns (*Figure 8.44*). Either the "Nearest neighbor" or "Inverse distance" weighted algorithms can be used to calculate output cell values. If the "Use Existing File" checkbox is selected, the actor will check to see if a file with the output file name already exists. If so, then the actor skips all actions

except for returning the existing file name (i.e., the actor does not "re-translate" the source data). Selecting the "use Existing File" parameter helps avoid lengthy rescaling calculations that have already been completed in prior runs. If the checkbox is not selected, any existing output file with the same name will simply be overwritten.

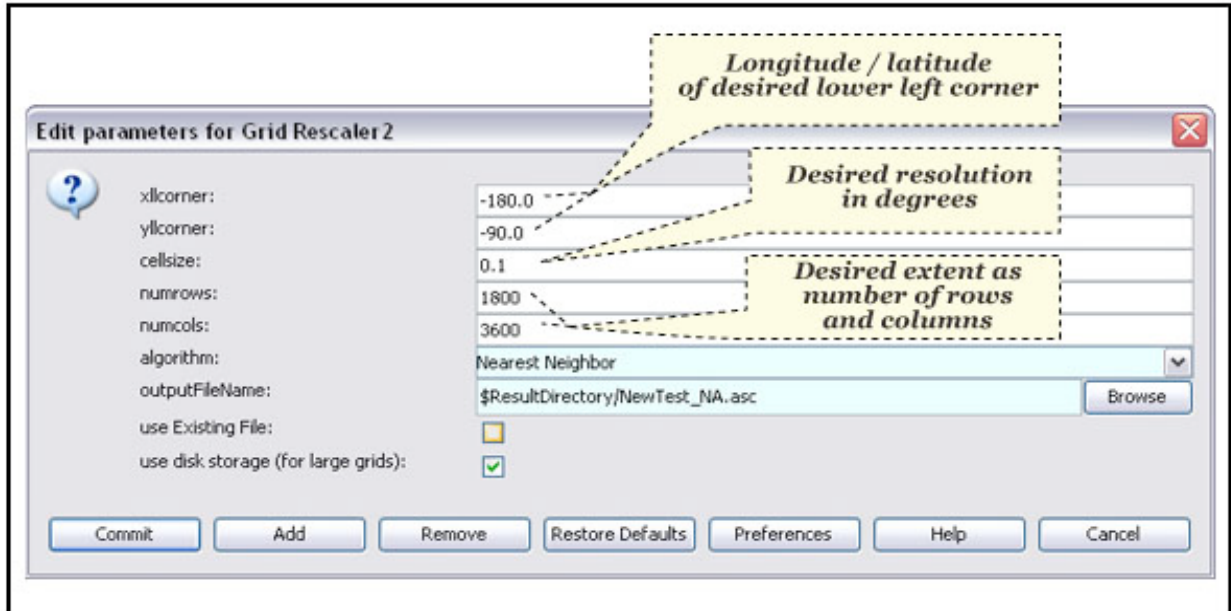

Figure 8.44: Parameters of the *GridRescaler* actor.

The example workflow uses a *MergeGrid* actor (called *SA_Mask*) to mask the transformed map. The *MergeGrid* actor receives the map data as well as the name of a mask file. Masked areas (e.g., oceans) will be assigned a value of "NO_DATA". The results are displayed with an *IJMacro* actor (*Figure 8.45*).



Figure 8.45: A topographical map of South America, output by the example workflow.

9. Domain Specific Workflows

This chapter contains example workflows that have been developed or are currently under development for specific domains: chemistry, ecology, geology, molecular biology, oceanography, and phylogeny.

9.1 Chemistry

The Kepler project in conjunction with the [RESURGENCE](#) project (RESearch sURGe ENabled by CyberinfrastructurE) has developed a general workflow infrastructure for computational chemistry that allows high-throughput calculations distributed on a computational grid.⁴⁷ To that end, the Kepler library contains a number of components designed to interface with commonly used computational chemistry tools such as GAMESS (General Atomic and Molecular Electronic Structure System), Open Babel, Babel, and QMView. To use the full suite of computational chemistry actors, these applications must be installed on the local system.

The workflow in *Figure 9.1* demonstrates how Kepler can be used to prepare and run a GAMESS experiment. All of the required applications necessary for file format translation, display, and processing are accessed and executed via workflow actors. Kepler actors also create all of the necessary directories and text files. The workflow is parameterized to allow for molecule selection, for setting the main scientific parameters, and for parsing the underlying program codes. Each of the actors in the workflow in *Figure 9.1* is a composite actor containing the individual actors required to perform the workflow step.

For detailed information about the GAMESS workflow, please see <https://code.kepler-project.org/code/kepler-docs/trunk/legacy-documents/user/WFDocumentation/LocalGAMESSPrepareRunDisplay.doc>

Preparing and running a GAMESS Experiment and displaying the results visually

Workflow Authors:

Wibke SUDHOLT, Kim BALDRIDGE: University of Zurich

Ilkay ALTINTAS: San Diego Supercomputer Center

⁴⁷ RESURGENCE project home page, <http://ocikbws.uzh.ch/resurgence/index.html>

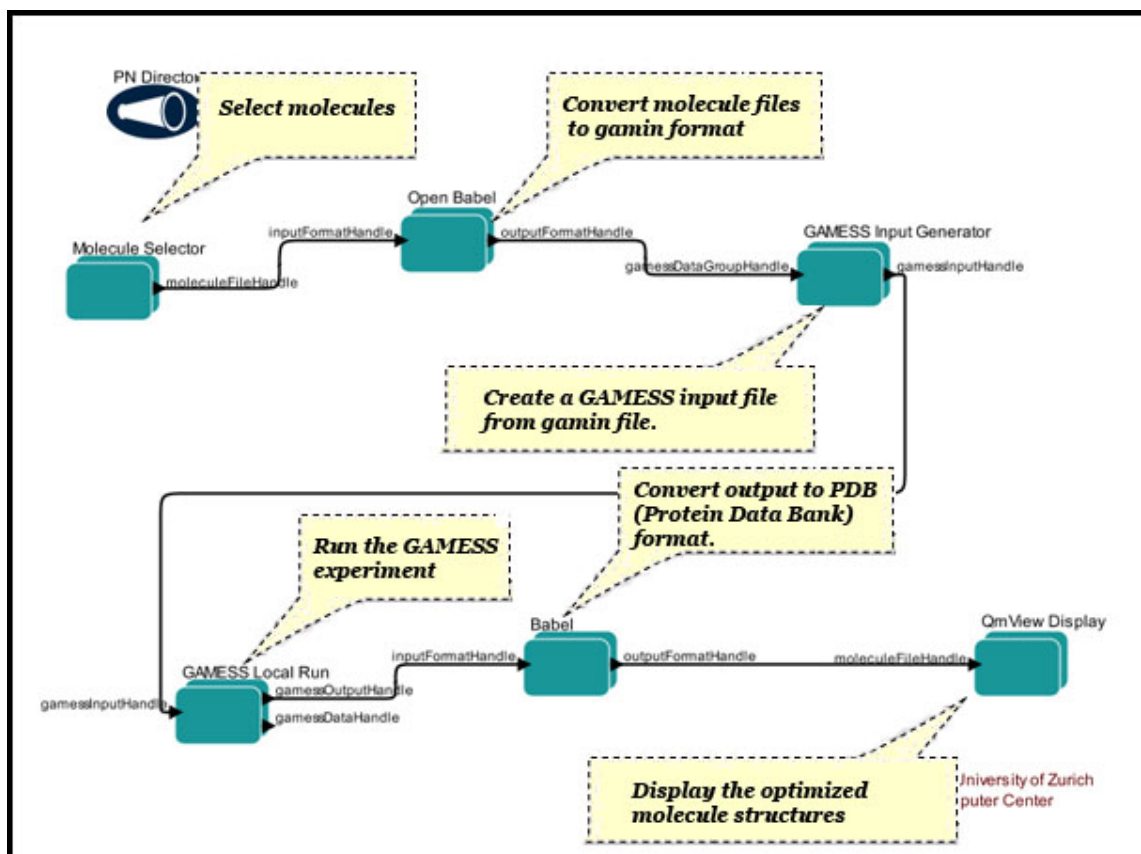

Figure 9.1: Preparing and running a GAMESS Experiment and displaying the results visually. This workflow runs high-throughput calculations of several molecules using the GAMESS quantum chemistry application. When completed, this workflow will enable users to obtain physical properties of all the molecules involved. The workflow will also display the final (optimized) structures of these molecules using QMView visualization software.

The *Preparing and running a GAMESS Experiment and displaying the results visually*: workflow can be found in the /workflows/chem/ directory of the nightly Kepler build. Please note that these workflows are under development and may not be fully functional.

9.2 Ecology

The National Science Foundation-funded [SEEK](#) (Science Environment for Ecological Knowledge) project-- the initial contributor to the Kepler project -- chose Ecological Niche Modeling (ENM) as the prototype Kepler application. SEEK selected this application because there were clear gains to be made through applying cutting-edge technology to niche modeling.

The project makes use of the data resources of the distributed Mammal Networked Information System (MaNIS; Stein and Wiczorek, 2004) to carry out a review of likely climate change effects on the over 2000 mammal species of the Americas, constructing

maps of potential species distributions under future climate scenarios. This analysis will be the broadest in taxonomic and geographic scope carried out to date, and the computational approach, the Kepler workflow (*Figure 9.2*) will be completely scalable and extensible to any region and any suite of taxa of interest.

For detailed information about ENM workflows, please see Kepler's Guide to ENM. Example workflows can be found in Kepler's /demos/ENM directory.

Ecological Niche Modeling

Workflow author:

Dan Higgins

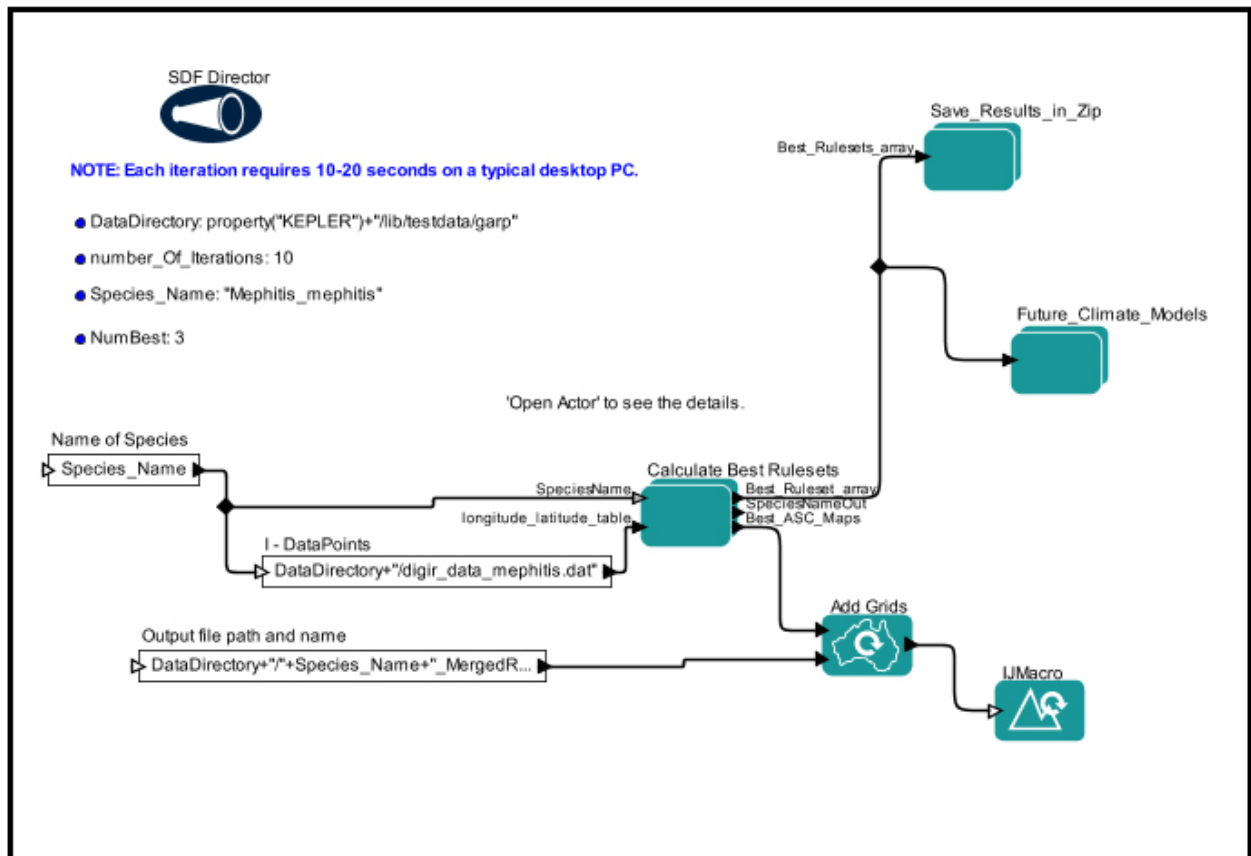

Figure 9.2: The GARP_SingleSpecies_BestRuleSet-IV.xml workflow, discussed in more detail in the Guide to ENM.

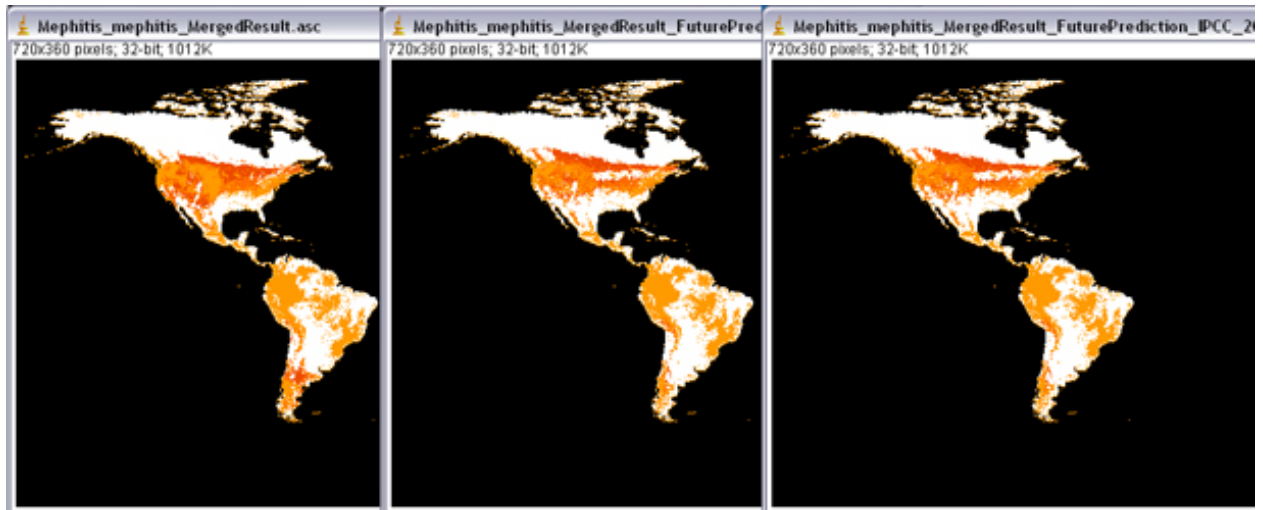

Figure 9.3: Maps output by the GARP_SingleSpecies_BestRuleSet-IV.xml workflow. The map on the far left displays a predicted distribution of *Mephitis mephitis* based on historical climate data. The map in the center displays a prediction based on future climate data for 2020. The map on the far right displays a prediction based on future climate data for 2050. The workflow also outputs a list of files used to generate the predictions (not pictured).

The *Ecological Niche Modeling* workflows can be found in the /demos/ENM/ directory.

9.3 Geology

The Kepler project in conjunction with the Geosciences Network (GEON) Project (<http://www.geongrid.org>) has developed a wide variety of workflows for geosciences research: a workflow for the integration and visualization of seismic events and their related fault orientations with other image (map) services⁴⁸; distribution, interpolation and analysis of LiDAR (Light Distance And Ranging) point cloud datasets⁴⁹; and mineral classification⁵⁰, among others.

The workflow in *Figure 9.4* is used to retrieve mineral classification points from the Virginia Igneous Rock database and to classify the points. The workflow connects to a data base of mineral compositions of igneous rock samples and selects data points. This data, together with a set of Igneous rocks diagrams (*Figure 9.5*) are fed into a Classifier sub-workflow, which automates the often time-consuming process of classifying mineral samples via a series of diagrams.

⁴⁸ Jaeger-Frank, Efrat, Chaitan Baru, Ashraf Memon, Ilkay Altintas, Bertram Ludaescher, Ghulam Memon & Dogan Seber. [Integrating Seismic Events Focal Mechanisms with Image Services in Kepler. 2005 ESRI User Conference Proceedings](#)

⁴⁹ Jaeger-Frank E, Crosby C J, Memon A, Nandigam V, Arrowsmith J R, Conner J, Altintas I and Baru C 2006 Three Tier Architecture for LiDAR Interpolation and Analysis *1st Int. Workshop on Workflow systems in e-Science in conjunction with ICCS*

⁵⁰ Ludscher, B, K. Lin, S. Bowers, E. Jaeger-Frank, B. Brodaric, C. Baru. Managing Scientific Data: From Data Integration to Scientific Workflows. *GSA Today*, Special Issue on Geoinformatics, 2005.

Geon mineral classification workflow

Workflow Authors:

Efrat Jaeger, Bertram Ludaescher, Krishna Sinha.

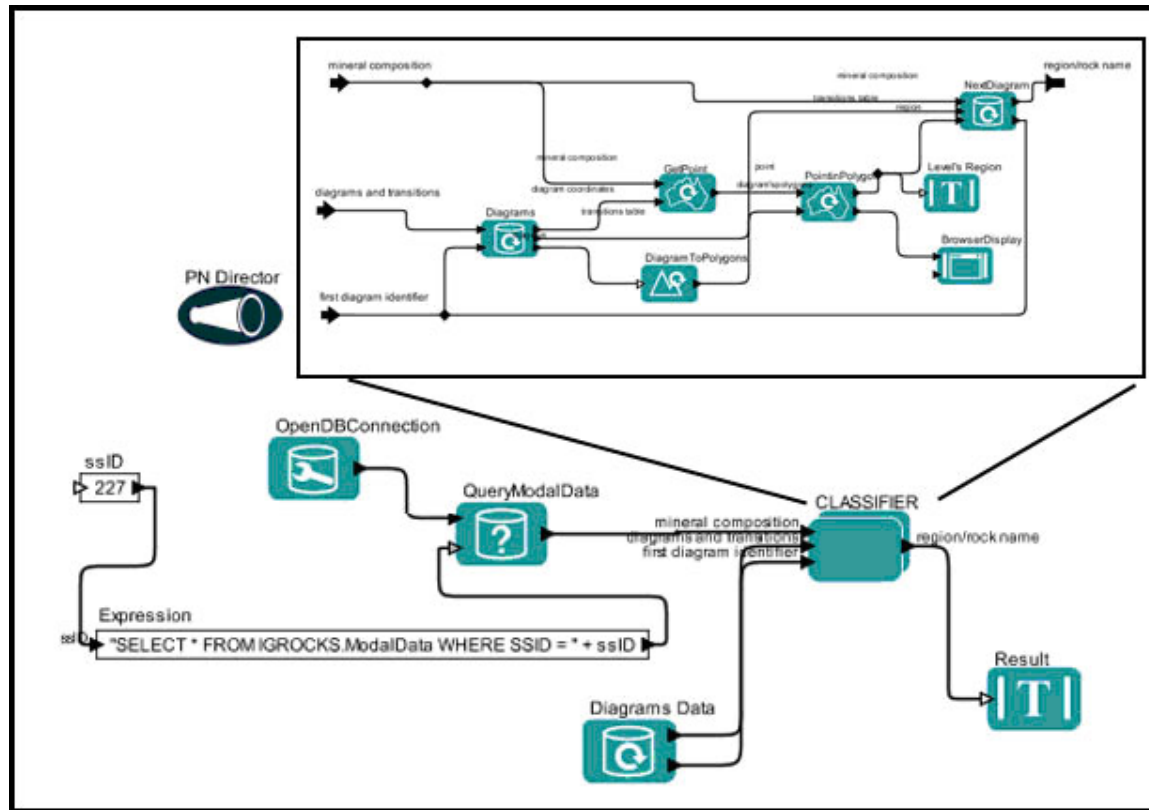

Figure 9.4: The GEON mineral classification workflow, which determines the position of the sample points in a series of diagrams such as the ones shown in *Figure 9.5*.

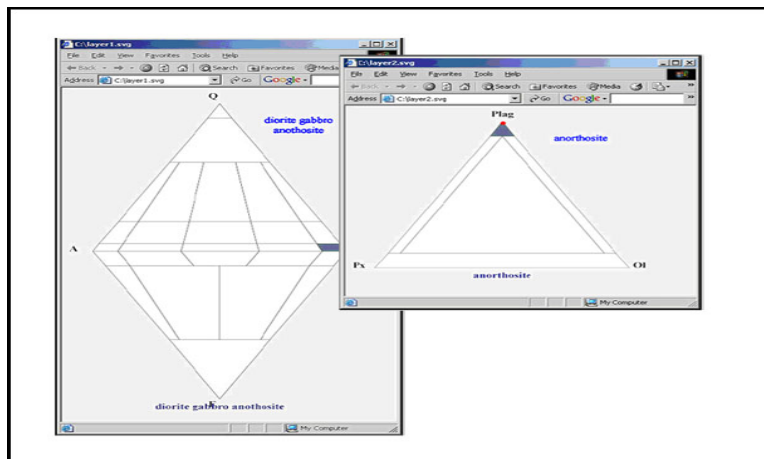

Figure 9.5: Igneous rock classification diagrams. If the location of a sample point in a non-terminal diagram of order n has been determined (e.g., diorite gabbro anorthosite, left), the corresponding diagram of order $n+1$ is consulted and the point is located therein. This process is iterated until the terminal level of diagrams is reached. The result is shown on the right, where the classification result is anorthosite⁵¹.

⁵¹ Ibid.

The *Geon mineral classification* workflow and other earth science workflows can be found in the /workflow/geo/ directory of the nightly Kepler build. Please note, these workflows are under development and may not be fully functional.

9.4 Molecular Biology

The Kepler project in conjunction with the [Scientific Process Automation](#) (SPA) project has developed a set of special "bio-services" actors that allow the scientist to invoke standard tools such as BLAST or Transfac locally or remotely as web services.⁵²

The Promoter Identification Workflow (PIW) shown in *Figure 9.6* links genomic biology techniques such as microarrays with bioinformatics tools such as BLAST to identify and characterize eukaryotic promoters. Starting from microarray data, cluster analysis algorithms are used to identify genes that share similar patterns of gene expression profiles which are then predicted to be co-regulated as part of an interactive biochemical pathway. Given the gene-ids, gene sequences are retrieved from a remote database (e.g., GenBank) and fed to a tool (e.g., BLAST) that finds similar sequences. In subsequent steps, transcription factor binding sites and promoters are identified to create a promoter model that can be iteratively refined.

For detailed information about this workflow, please see the original article.⁵³

Promoter Identification Workflow (PIW)

Workflow Authors:

Matthew Coleman @ Lawrence Livermore National Laboratory

Ilkay Altintas, Bertram Ludaescher, Yang Zhao @ San Diego Supercomputer Center

⁵² SPA web site, <http://www-casc.llnl.gov/sdm/documentation/overview.php>

⁵³ Altintas, Ilkay, Oscar Barney, Zhengang Cheng, Terence Critchlow, Bertram Ludaescher, Steve Parker, Arie Shoshani, Mladen Vouk. Accelerating the scientific exploration process with scientific Workflows. *Journal of Physics: Conference Series*, 2006

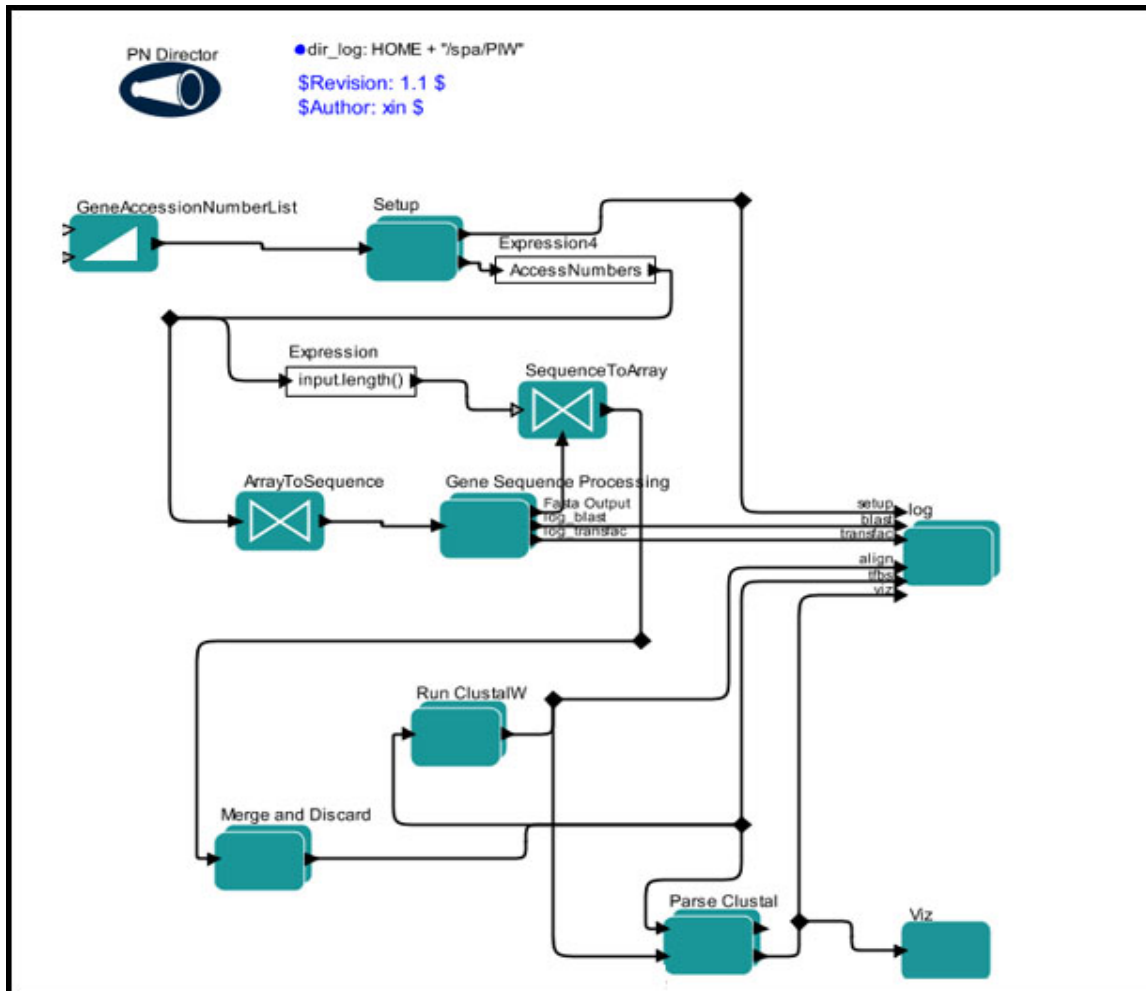

Figure 9.6: The Promoter Identification Workflow (PIW)

The *Promoter Identification Workflow* can be found in the `/workflow/spa/PIW/` directory of the nightly Kepler build. Note that these workflows are under development and may not be fully functional.

9.5 Oceanography

The Kepler project in conjunction with the [ROADNet \(Real-time Observatories, Applications, and Data Management Network\)](http://roadnet.ucsd.edu/) project has developed an integrated, seamless, and transparent information management system that will deliver seismic, oceanographic, hydrological, ecological, and physical data to a variety of end users in real-time.⁵⁴

⁵⁴ ROADNet project website, <http://roadnet.ucsd.edu/>

The *Graphical Display of Real-Time Geophysical Data* workflow (Figure 9.7) displays images taken on the research vessel, the Roger Reville in real time. For more information about the technologies used in this workflow, please see <http://nibot-lab.livejournal.com/28612.html>.

Graphical Display of Real-Time Geophysical Data

Workflow authors:

Tobin T. Fricke, University of California

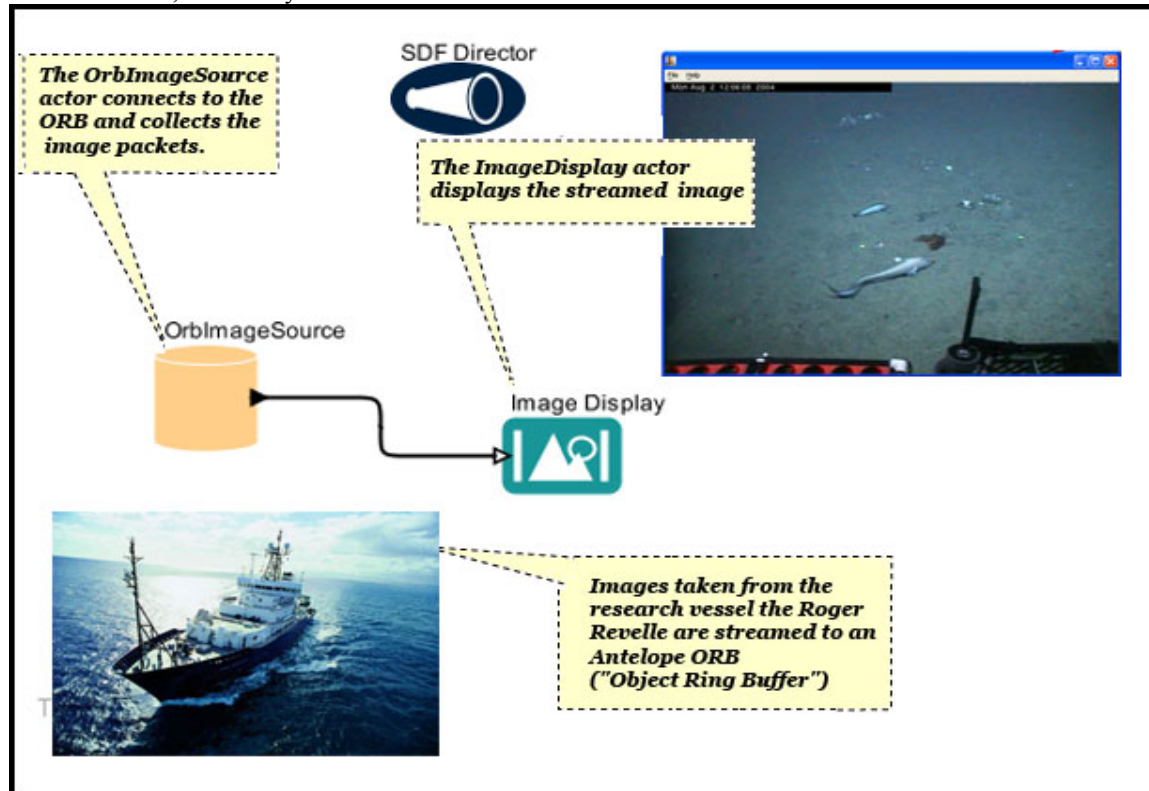

Figure 9.7: The *Graphical Display of Real-Time Geophysical Data* workflow displays images taken on the research vessel, the Roger Reville in real time.

The *Graphical Display of Real-Time Geophysical Data* workflow as well as other related workflows can be found in the `/workflows/orb/` directory of the nightly Kepler build. Note that these workflows are under development and may not be fully functional.

9.6 Phylogeny

The Kepler project in conjunction with the [Cyberinfrastructure for Phylogenetic Research](http://www.phylo.org) (CIPRES) project has been developing components and workflows to enable large-scale phylogenetic reconstructions on a scale that will enable analyses of huge data sets containing hundreds of thousands of bio molecular sequences.⁵⁵ Please download the Cipres-Kepler software package from http://www.phylo.org/sub_sections/software/ to begin building scientific workflows for phylogenetic data analyses.

⁵⁵ CIPRES project website, <http://www.phylo.org/>

The *Alignment-Inference-Visualization Workflow* (Figure 9.8) reads a Nexus file, uses [ClustalW](#) to perform a multiple sequence alignment on the data, constructs the phylogenetic tree using [PAUP](#), and reads and displays the tree using the [Forester](#) tree viewer. For detailed information about the workflow, please see the CIPRES website, http://www.phylo.org/sub_sections/software/.

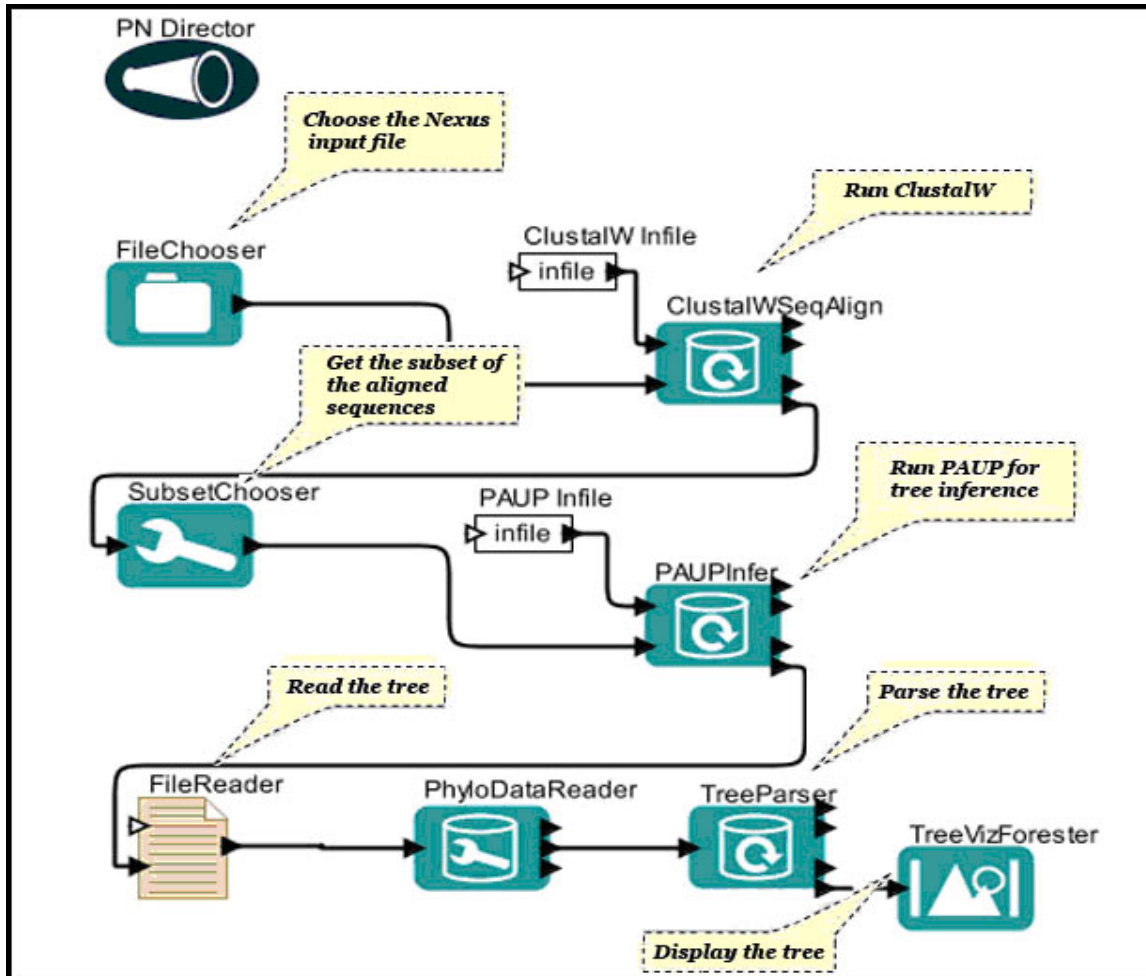

Figure 9.8 The Alignment-Inference-Visualization Workflow⁵⁶

The *Alignment-Inference-Visualization Workflow* is included with the CIPRES-Kepler software package.

⁵⁶ Guan, Zhijie [PowerPoint presentation](#) of CIPRES in Kepler (given at the 2006 Evolution meetings).

Appendix A: Creating New Actors

One of the simplest ways to create a new actor (and a good way to get started building your own actors immediately) is to customize an existing actor. Actors can be customized, saved to a KAR file and displayed in the library and/or uploaded to the repository--all from the Workflow canvas. Users need not know Java or any other programming language to create powerful new components in this way. Users who are familiar with Java can also choose to write and compile new actors from source code. In this chapter, we will look at how to create an actor by customizing an existing one, as well as how to create an actor "from scratch" by extending existing Java code, compiling it, and importing the new actor into Kepler.

In Section A.1, we will look at how to create, save, and share a customized *Expression* actor. In Section A.2, we will look at the structure of an actor and how actors work: how the code is structured, how to create ports, parameters, and behaviors (i.e., methods) and how to compile custom actors and then import them into the Kepler. At the end of the chapter, we step through tutorial examples designed to introduce you to the basics of building and incorporating your own actors into Kepler.

A.1 Building a Custom Actor Based on an Existing Actor

One of the simplest ways to create a new actor is to customize an existing actor--usually either an *Expression* or *RExpression* actor, which are easy to modify in useful ways. Users can add ports, customize parameters (such as an R-script or expression), and create powerful components that are easily saved and stored in a Kepler archive (KAR) file, which can be shared with others.

In this section, we will take a look at how to create an actor (the *Shannon Index* actor) that evaluates an equation and outputs the result. The *Shannon Index* actor, which is used to calculate a measure of biodiversity in categorical data, is based on an *Expression* actor included in the standard Kepler library.

The Shannon Biodiversity Index can be calculated using the following equation⁵⁷:

$$H' = -\sum_{i=1}^s \left[\left(\frac{n_i}{n} \right) \ln \left(\frac{n_i}{n} \right) \right]$$

⁵⁷ From Statistical Ecology by John A. Ludwig and James F. Reynold, 1988

In the above equation, n_i is the number of individuals in each species (the abundance of each species) S represents the number of species in the sample (the "species richness"); and n is the total number of individuals.⁵⁸

Before an *Expression* actor can evaluate an equation, the equation must be "translated" into the Kepler expression language. For detailed information about the expression language, please see the [Ptolemy documentation](#). The Shannon Biodiversity Index equation is written in the expression languages as follows:

```
-1.0*sum(map(function(x:double)
(1.0*x/sum(numSp))*(log(1.0*x/sum(numSp))), numSp))
```

`numSp` is an array that must be provided to the actor. Each element in the array represents the species abundance of a species in the sample. In other words, the number of elements in the array is the number of species in a sample (S), and the value of each element is the number of individuals of the corresponding species (n_i). For example, the array $\{10,20,30,40\}$ represents a data set containing four species, one species having 10 individuals, the next having 20 individuals, etc. Summing the elements gives the total number of individuals (n), which is equal to 100 in this example.

To begin using this equation, paste it into the `value` parameter of an *Expression* actor, add an input port named `numSp` (which will receive the data set array), and rename the actor "Shannon Index" to better identify its function. This actor can now be connected to other actors and used in a workflow (*Figure A.1*).

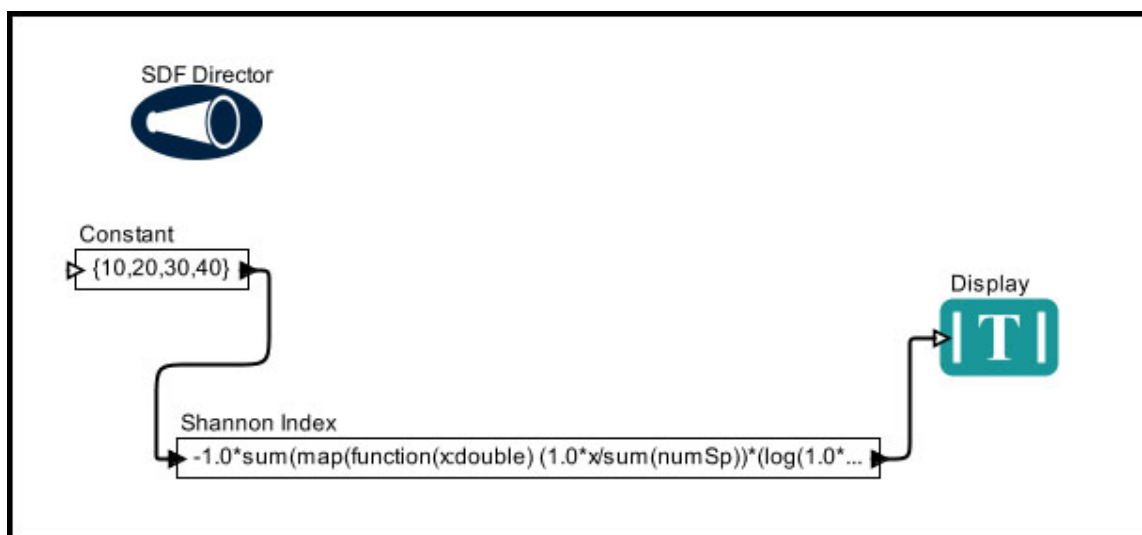

Figure A.1: A simple workflow that calculates the Shannon Biodiversity Index, used to measure diversity in [categorical data](#).

⁵⁸ Wikipedia, http://en.wikipedia.org/wiki/Shannon_index

To save the *Shannon Index* (or any other customized actor) to your library, right-click the actor and select the Save Archive (KAR)...” menu item. This will save the actor in a KAR file on your computer’s hard drive. If that KAR file is in a folder that is designated as a Local Repository for Kepler components it will appear in the Component Library within Kepler.

A KAR file (‘K’eppler ‘AR’chive) is a zipped collection of files that can easily be shared with others. To examine the contents of a KAR file, open it with a zip file editor (like WinZip). The ShannonIndex.kar file contains two files: ‘Manifest.mf’ and an xml file. These files contain information that Kepler uses when building the actor library and displaying the actor in the work space. For more information about the files, see Section A.4.1.

To begin using the actor, make sure the KAR file is saved in a Local Repository folder. Press the “Sources” button just below the search field in the Component Library, here you can add, rename, and remove Local Repository folders. To resynchronize your Component Library with the KAR files in your local repositories you can press the “Build” button in the Component Preferences dialog that opened when you pressed the “Sources” button. You can now search for your new actor in the Component Library.

A.2 Creating a New Actor by Extending a Java Class

Typically, new actors are created by extending an existing Java class. A *class* is the blueprint from which individual objects (e.g., an instance of an actor displayed on the Workflow canvas) are created.⁵⁹ By extending a class, the new actor will inherit all of the commonly used attributes and behaviors from the parent class—ports and parameters, for example, or what tasks to perform at different times (i.e., methods). Only new behaviors and attributes need be programmed. In addition to eliminating the need to reinvent the wheel each time an actor is created, extending base classes helps maintain consistent naming conventions, as the port and parameter names are inherited (eliminating the confusion created when one actor has an input port called "in" and another "inSystem", etc).

To create a new actor and begin using it, you need installed Kepler software and a Java development kit (JDK). To see if you have the development kit running (not just the Java runtime environment (JRE)), navigate to the directory in which Java is installed and then open the "bin" directory (e.g., JAVA_HOME/bin). If the directory contains a program called javac.exe, you are ready to get started! If you don't see javac.exe, or you're unsure in any way, go to http://java.sun.com/javase/downloads/index_jdk5.jsp and download JDK5 or go to <http://java.sun.com/javase/downloads/index.jsp> and download JDK6. Note that you can use any application to code actors—from Eclipse, a common code-development environment to a simple text editor. Full instructions for using Eclipse with

⁵⁹ The Java Tutorials, <http://java.sun.com/docs/books/tutorial/java/concepts/class.html>

Kepler are available on the [Kepler wiki, where the build system instructions are available.](#)

A.2.1 Coding a New Actor

The source code of Kepler actors is divided into several sections with highly visible delimiters (*Figure A.2*). The sections consist of: constructors, public variables (including ports and parameters), public methods, protected methods, protected variables, private methods, and private variables, in that order.⁶⁰ The constructor creates an instance of the class (the actor) and the methods specify the actor behaviors (such as what to send to an output port). "Public", "protected", and "private" specify access levels. Please see the [Java documentation](#) for more information.

Because Kepler is a collaborative project, adhering to consistent formatting and naming conventions is especially important. Please see [Sun's Developer Network](#) for information about best practices.

Each Java source begins with a brief (usually one sentence) description of the actor that identifies what the actor does and how it is intended to be used. This line appears at the top of the file, above the copyright notice and the Java import statements. The copyright is a "BSD" ("Berkeley Standard Distribution") copyright, which is more liberal than the GPL (Gnu Public License). To view the copyright license, right-click any actor in the default Kepler library and select Open Actor.

⁶⁰ Hylands Brooks, Christopher, and Edward A Lee, Ptolemy II Coding Style

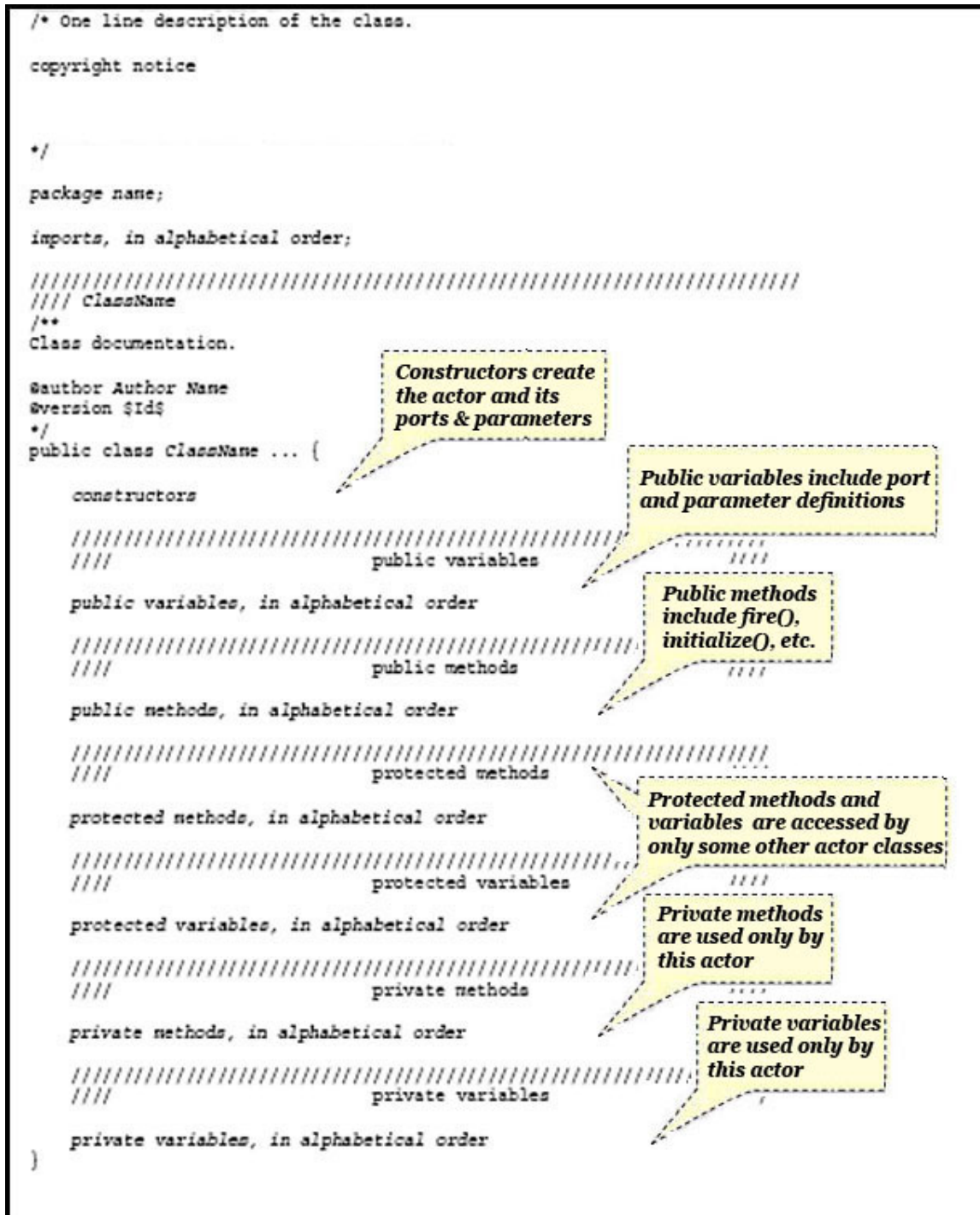

Figure A.2: Generic actor template with major sections identified: constructors, public variables (including ports and parameters), public methods, protected methods, protected variables, private methods, and private variables.

The template in *Figure A.2* shows the major sections of the actor Java code. We will discuss each section in more depth in the next pages.

A.2.1.1 The Constructor

The constructor is the part of the Java code that creates each instance of the class (i.e., each actor). The class behaviors (methods), ports, and parameters are defined in other sections of the code. The constructor takes this "blueprint" and builds the actor.

Each actor must have its own constructor (the constructor is not "inherited"). The constructor contains documentation—Javadoc comments that are compiled when the code is compiled—as well as Java code that builds the actor and its ports and parameters.

The constructor section of code displayed in *Figure A.3* contains the constructor code for the *Constant* actor. Right-click the *Constant* actor and select Open Actor to see the complete Java source code.

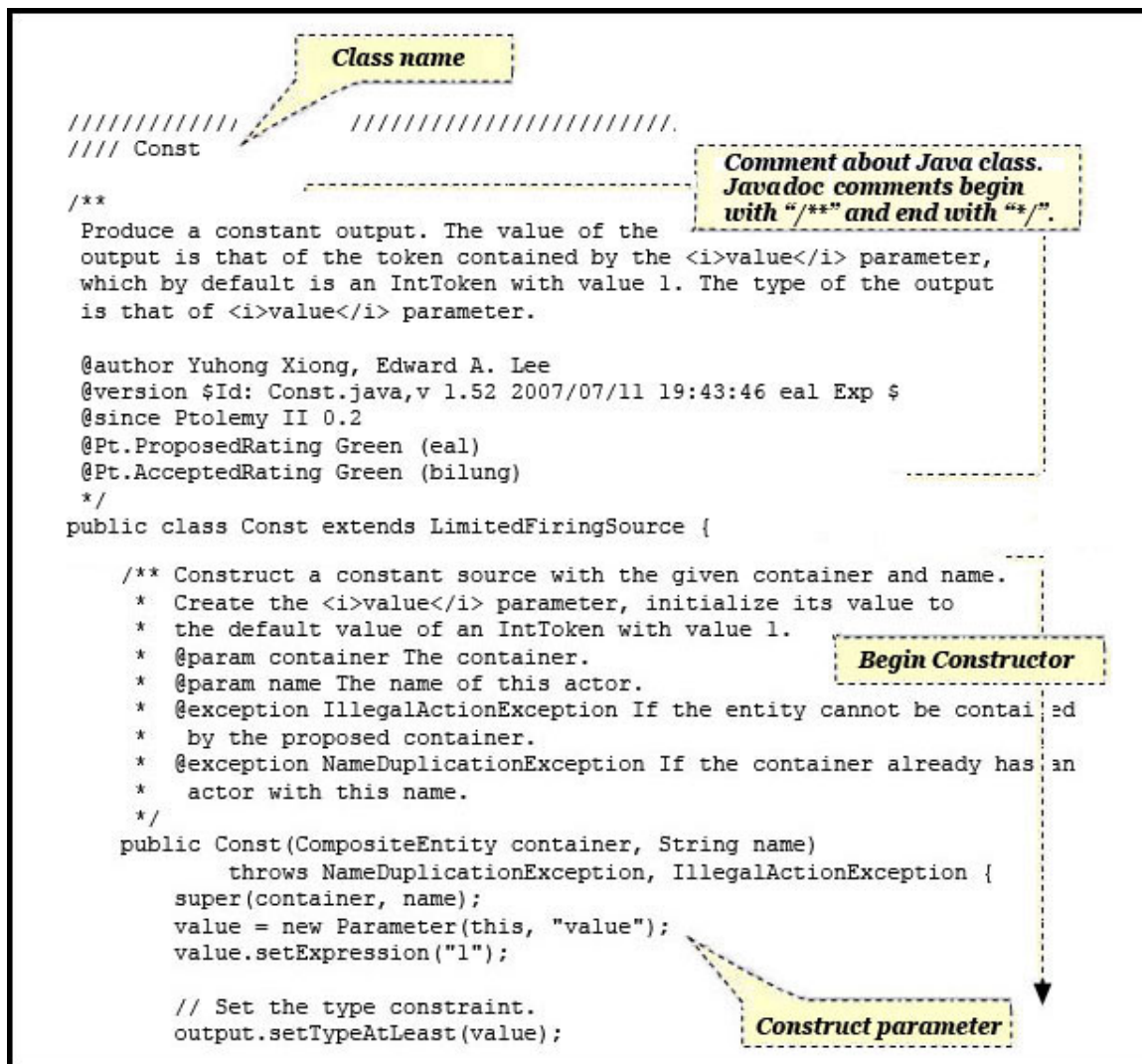

Figure A.3: The constructor of the *Constant* actor.

The section of code displayed in *Figure A.3* begins with the class name (`Const`) as well as documentation for the class. The `Const` class extends the `LimitedFiringSource` class. In other words, the *Constant* actor will inherit the functionality of the pre-existing class.

The class documentation for the *Constant* actor is:

```
Produce a constant output. The value of the output is
that of the token contained by the <i>value</i>
parameter, which by default is an IntToken with value 1.
The type of the output is that of <i>value</i>
parameter.
```

Documentation is specified as Javadocs. Javadoc is a program distributed with Java that generates HTML documentation files from Java source code files. Javadoc comments begin with “`/**`” and end with “`*/`”, and should always precede the class definition, the constructor, and each defined port, parameter, and method to convey to other users what the code does.⁶¹ Note that the description can contain HTML formatting (e.g., `<i>value</i>`).

Javadoc tags (e.g., `@author ...`) convey information about the actor's author, code version, and status (*Table 10.1*):

```
@author Yuhong Xiong, Edward A. Lee
@version $Id$
@since Ptolemy II 0.2
@Pt.ProposedRating Green (eal)
@Pt.AcceptedRating Green (bilung)
```

Javadoc Tag	Value
<code>@author</code>	The authors and contributors (e.g., Yuhong Xiong, Edward A. Lee)
<code>@version</code>	Version information. The default value <code>\$Id\$</code> is replaced by actual version information when the code is committed to CVS (e.g. <code>\$Id: Const.java,v 1.52 2007/07/11 19:43:46 eal Exp \$</code>)
<code>@since</code>	The release in which the class first appeared. Usually, the release is one decimal place after the current release. For example, if the current release is 3.0.2, then the <code>@since</code> tag would read: <code>@since Ptolemy II 3.1</code>
<code>@Pt.ProposedRating</code>	Proposed code rating. Each tag includes the color (one of red, yellow, green, or blue) and the cvs login of the person responsible for the proposed or accepted rating level. See the Ptolemy documentation for more information.

⁶¹ See <http://java.sun.com/j2se/javadoc/writingdoccomments/> for guidelines from Sun Microsystems on writing Javadoc comments.

`@Pt.AcceptedRating` Accepted code rating. Each tag includes the color (one of red, yellow, green, or blue) and the cvs login of the person responsible for the proposed or accepted rating level. See the [Ptolemy documentation](#) for more information.

Table A.1: Javadoc tags used to identify a class

The constructor itself should also be preceded by a Javadoc comment. The Javadoc comments that describe the constructor begin "Construct a ...", and explain what the constructor is doing: creating an actor parameter called `value` and assigning it a default value of 1, and throwing exceptions under certain circumstances. Ports and parameters, which are defined under the Public Variables section of the actor code, are instantiated in the constructor. We'll look more closely at how this is done in Section 10.2.3 Public Variables: Actor Ports and Parameters.

A.2.1.2 Public Methods (Action methods and more)

How actors behave (e.g., what they output and when) is described by methods. Kepler actors have a number of common "action" methods that tell the actor what to do at various times during workflow execution: `preinitialize()`, `initialize()`, `prefire()`, `fire()`, `postfire()`, and `wrapup()`. Different types of tasks happen at different points in the workflow. Note that by convention methods are specified alphabetically in the actor's source code (*Table 10.2*).

Method	Use
<i>preinitialize()</i>	Set port types and/or scheduling information. The <code>preinitialize()</code> method is only invoked once per workflow execution and is invoked before any of the other action methods.
<i>initialize()</i>	Initialize local variables and begin execution of the actor.
<i>prefire()</i>	Determine whether firing should proceed. This method is invoked each time the actor is fired, before the actor is fired. The method can also be used to perform an operation that will happen exactly once per iteration.
<i>fire()</i>	Read actor inputs and current parameter values, and produce outputs.
<i>postfire()</i>	Determine if actor execution is complete, schedule the next firing (if appropriate) and update the actor's persistent state.

<i>wrapUp()</i>	Display final results. The wrapUp() method is only invoked once per workflow execution.
-----------------	---

Table A.2: Common action methods and their use.

The public methods of the *AddOrSubtract* actor are displayed in *Figure A.4*. Only the *fire()* method is defined--the other methods are inherited unchanged from the parent actor (the *AddOrSubtract* actor extends *TypedAtomicActor*).

```

////////////////////////////////////
////                                     public methods
/** If there is at least one token on the input ports, add
 * tokens from the <i>plus</i> port, subtract tokens from the
 * <i>minus</i> port, and send the result to the
 * <i>output</i> port. At most one token is read
 * from each channel, so if more than one token is pending, the
 * rest are left for future firings. If none of the input
 * channels has a token, do nothing. If none of the plus channels
 * have tokens, then the tokens on the minus channels are subtracted
 * from a zero token of the same type as the first token encountered
 * on the minus channels.
 *
 * @exception IllegalArgumentException If there is no director,
 * or if addition and subtraction are not supported by the
 * available tokens.
 */
public void fire() throws IllegalArgumentException {
    super.fire();
    Token sum = null;

    for (int i = 0; i < plus.getWidth(); i++) {
        if (plus.hasToken(i)) {
            if (sum == null) {
                sum = plus.get(i);
            } else {
                sum = sum.add(plus.get(i));
            }
        }
    }

    for (int i = 0; i < minus.getWidth(); i++) {
        if (minus.hasToken(i)) {
            Token in = minus.get(i);

            if (sum == null) {
                sum = in.zero();
            }

            sum = sum.subtract(in);
        }
    }

    if (sum != null) {
        output.send(0, sum);
    }
}

```

Figure A.4: The public methods (in this case, just the `fire()` method) defined for the *AddOrSubtract* actor.

Each method defined in the public method section should be preceded by a Javadoc comment that describes what the method does and how it is used.

Note that the java code for the `fire()` method uses a number of other methods to access and process data: the `send()` method sends data to a specified port channel; the `get()` method retrieves data from ports; the `getWidth()` method returns the number of channels of data received; the `hasToken()` method determines if a port has available data. For more information about useful methods and syntax, please refer to the [Ptolemy documentation](#).

A.2.1.3 Public Variables: Actor Ports, Parameters, and Port-Parameters

Actor ports and parameters are created by including the relevant Java classes in the actor's source code: usually `TypedIOPort` to create an input or output port, `Parameter` to create a parameter, and `PortParameter` to create a port-parameter. To use these classes, first add them to the imports list:

```
import ptolemy.actor.TypedIOPort;
import ptolemy.data.expr.Parameter;
import ptolemy.actor.parameters.PortParameter;
```

Figure A.5 displays the ports and parameters section of the `AddOrSubtract` actor, which has three ports: two input ports, one called `minus` and the other `plus`, and one output port called `output`) and no parameters. Note that each port declaration is preceded by a Javadoc comment that describes the port and its use.

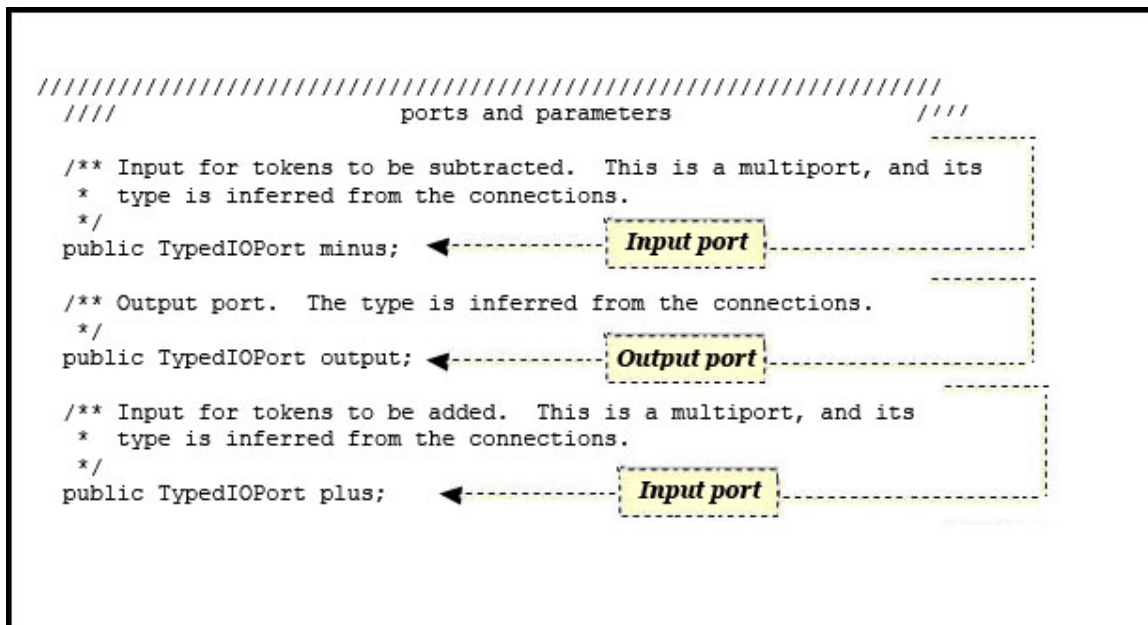

Figure A.5: The input and output ports of the `AddOrSubtract` actor.

Though the ports are defined in the "ports and parameters" section of code, they are actually created by the constructor. In other words, just declaring the ports will not create them. They must be instantiated, which is accomplished with the `AddOrSubtract` actor's constructor code highlighted in Figure A.6.

```

/** Construct an actor in the specified container with the specified
 * name.
 * @param container The container.
 * @param name The name of this adder within the container.
 * @exception IllegalArgumentException If the actor cannot be contained
 * by the proposed container.
 * @exception NameDuplicationException If the name coincides with
 * an actor already in the container.
 */
public AddSubtract(CompositeEntity container, String name)
    throws IllegalArgumentException, NameDuplicationException {
    super(container, name);
    plus = new TypedIOPort(this, "plus", true, false);
    plus.setMultiport(true);
    minus = new TypedIOPort(this, "minus", true, false);
    minus.setMultiport(true);
    output = new TypedIOPort(this, "output", false, true);

    _attachText("iconDescription", "<svg>\n"
        + "<rect x=\"-20\" y=\"-20\" \" + "width=\"40\" height=\"40\" \"
        + "style=\"fill:white\"/>\n" + "<text x=\"-13\" y=\"-5\" \"
        + "style=\"font-size:18\">\n" + "+ \n" + "</text>\n"
        + "<text x=\"-13\" y=\"7\" \" + "style=\"font-size:18\">\n"
        + "_ \n" + "</text>\n" + "</svg>\n");
}

```

Figure A.6: Constructing the ports of the *AddOrSubtract* actor.

The code that instantiates a port takes the following form:

```
portName = new TypedIOPort (arguments)
```

For example, the first instantiated port in *Figure A.6* is the `plus` port:

```
[1] plus = new TypedIOPort(this, "plus", true, false);
[2] plus.setMultiport(true);
```

Line [1] instantiates the `plus` port. The first argument (i.e., `this`) is the container of the port, this actor. The second is the name of the port ("plus"), which can be any string, but by convention, is the same as the name of the public variable. The third argument specifies whether the port is an input (it is in this example), and the fourth argument specifies whether it is an output (it is not in this example). By default, ports are single ports. Line [2] "overrides" the default, stating that the `plus` port should be a multiport instead of a single port.

The constructor also sets type constraints. For example, if the `plus` port described above requires input of type `double`, the following absolute type constraint could be added to the constructor:

```
[3] plus.setTypeEquals(BaseType.DOUBLE);
```

More commonly, type constraints are specified as "relative type constraints," meaning that the type is equal to or greater than the type of another port or parameter. If the type of the `plus` port should be the same as the type of the `minus` port, the following line could be used:

```
[3] plus.setTypeSameAs(minus);
```

For full details of the type system, see the Ptolemy documentation.

Parameters are declared and constructed much like ports are. *Figure A.7* displays the ports and parameters section of the *Ramp* actor code. The *Ramp* actor inherits two ports from its parent class, but creates two new members: a parameter (called `init`) and a port-parameter (called `step`).

```

////////////////////////////////////
////                          ports and parameters                          ////
/** The value produced by the ramp on its first iteration.
 * The default value of this parameter is the integer 0.
 */
public Parameter init;
/** The amount by which the ramp output is incremented on each
 * The default value of this parameter is the integer 1.
 */
public PortParameter step;

```

Figure A.7: The ports and parameters code of the *Ramp* actor.

The *Ramp* actor's `init` parameter and the `step` port-parameter must also be instantiated by the constructor before they will appear. *Figure A.8* highlights the portion of the *Ramp* actor's constructor code that instantiates the new class members and sets the type of an existing member, the `output` port.

```

/** Construct an actor with the given container and name.
 * In addition to invoking the base class constructors, construct
 * the <i>init</i> and <i>step</i> parameter and the <i>step</i>
 * port. Initialize <i>init</i>
 * to IntToken with value 0, and <i>step</i> to IntToken with value 1.
 * @param container The container.
 * @param name The name of this actor.
 * @exception IllegalArgumentException If the actor cannot be contained
 * by the proposed container.
 * @exception NameDuplicationException If the container already has an
 * actor with this name.
 */
public Ramp(CompositeEntity container, String name)
    throws NameDuplicationException, IllegalArgumentException {
    super(container, name);
    init = new Parameter(this, "init");
    init.setExpression("0");
    step = new PortParameter(this, "step");
    step.setExpression("1");

    // set the type constraints.
    output.setTypeAtLeast(init);
    output.setTypeAtLeast(step);

    _attachText("_iconDescription", "<svg>\n"
        + "<rect x=\"-30\" y=\"-20\" " + "width=\"60\" height=\"40\" "
        + "style=\"fill:white\"/>\n"
        + "<polygon points=\"-20,10 20,-10 20,10\" "
        + "style=\"fill:grey\"/>\n" + "</svg>\n");
    _resultArray = new Token[1];
}

```

Figure A.8: Constructing the `init` parameter and `step` port-parameter and setting type constraints for the actor's output port.

The code that instantiates a parameter takes the following form:

```
paramName = new Parameter (arguments)
```

For example, the `init` parameter in *Figure A.8* uses:

```
[1] init = new Parameter (this, "init");
[2] init.setExpression("0");
```

Line [1] instantiates the `init` parameter. The first argument (i.e., `this`) is the container of the parameter, this actor. The second is the name of the parameter ("init"), which can be any string, but by convention, is the same as the name of the public variable. Line [2] specifies a default value for the parameter, in this case, 0.

A.2.1.4 Actor Icons

Actor icons, which appear on the Workflow canvas as well as in the actor tree, are assigned via external mappings, and NOT in the actor code. The icons themselves are SVG (scalable vector graphic) files.

In order to achieve visual consistency among the icons and to limit the number of icons in use, as well as to classify the icons into families that share a common function, we ask that you select an existing icon or icon family if possible. For a complete list of actor icons and their function, please see Section 5.3.1 Actor Icon Families.

For complete instructions, please see [Assigning/Adding Icons in Kepler](#)

A.2.2 Compiling a New Actor

To compile new actors please see the online developer documentation at <https://kepler-project.org/developers> and

<https://kepler-project.org/developers/teams/build/documentation/developing-a-hello-world-actor-using-the-kepler-build-system-and-eclipse>

A.4 Sharing an Actor: Creating a KAR File

To save an actor and share it with other users, either save the actor as a KAR file (a Kepler Archive format that allows actors to be easily transported and used), or upload the actor to the Kepler repository, where it can be shared by the general public. If the actor is built from a new Java source, the KAR file must include a dependency on the module where the Java class has been compiled.

A.4.1 The Manifest File

The manifest file (MANIFEST.MF) is a simple text document that helps uniquely identify an actor. It contains versioning information as well as the location of the actor's MOML file and its LSIDs (Life Science Identifier)—one for the KAR file, another for the actor. The manifest also contains information about the actors source code, when relevant (i.e., when the actor is compiled from new source code).

Each actor must have a unique LSID. The LSIDs of actors in the standard Kepler library take the form:

urn:lsid:kepler-project.org:actor:7:1.

In this case, kepler-project.org is acting as the "authority", actor is acting as the "namespace", 7 as the "object id", and 1 as the "version". For your own actors, you might try making up your own namespace to replace "actor" with. For more information about LSIDs and their syntax, please see <https://kepler-project.org/developers/teams/framework/kepler-life-science-identifiers-keplerlsid>.

To view Manifest files for existing KAR files right click on the KAR in the Component Library and choose the "View Manifest" menu item. More information about KAR files can be found at <https://kepler-project.org/developers/teams/framework/kepler-archive-kar>

A.4.2 The MOML File

MoML is an XML modeling markup language intended for specifying interconnections of parameterized, hierarchical components—such as actors and workflows.⁶² Each actor has a MOML file that describes it: its ports, parameters, settings, documentation, semantic type (i.e., where it appears in the actor tree), and identifier (the LSID).

All MOML files begin with an XML declaration, which specifies the version of XML being used:

```
<?xml version="1.0" ?>
```

The bulk of the MOML file is contained between start and end `<entity>` tags that surround a "body" of nested tags describing specific actor properties. People familiar with XML will recognize the structure. Please note that all tags must be closed either with an end tag (e.g., `<entity>...</entity>`) if the tag surrounds content, or a closing `>` (e.g., `<property... />`) if the tag is empty.

The opening `<entity>` tag specifies the name and class of the actor's container.

```
<entity name="SshSession" class="ptolemy.kernel.ComponentEntity">
```

Inside the `<entity>` tag are tags that define the specific actor properties and parameters, such as its LSID, user documentation (which overrides any documentation in the Java source code), ports, parameters, and location in the actor tree.

Please see the [Ptolemy documentation](#) for a complete guide the syntax and components of a MOML file.

⁶² Edward A. Lee, Stephen Neuendorffer. "MoML — A Modeling Markup Language in XML — Version 0.4". Technical report, University of California at Berkeley, March, 2000.

Appendix B: Modules

Kepler is broken up into units of software functionality known as modules. Modules have three primary purposes:

- To group related core Kepler software functionality together in logical units.
- To enable addition functionality to be easily added to Kepler.
- To enable existing Kepler functionality to be easily substituted by different functionality.

What you need to know about modules differs based on whether you are primarily a scientific user, a developer, or both. We will start with the user perspective.

11.1 The Module Manager

The module manager is the primary means by which users will interact with modules. It can be accessed from the file menu by clicking Tools-->Module Manager... There are two tabs in the module manager.

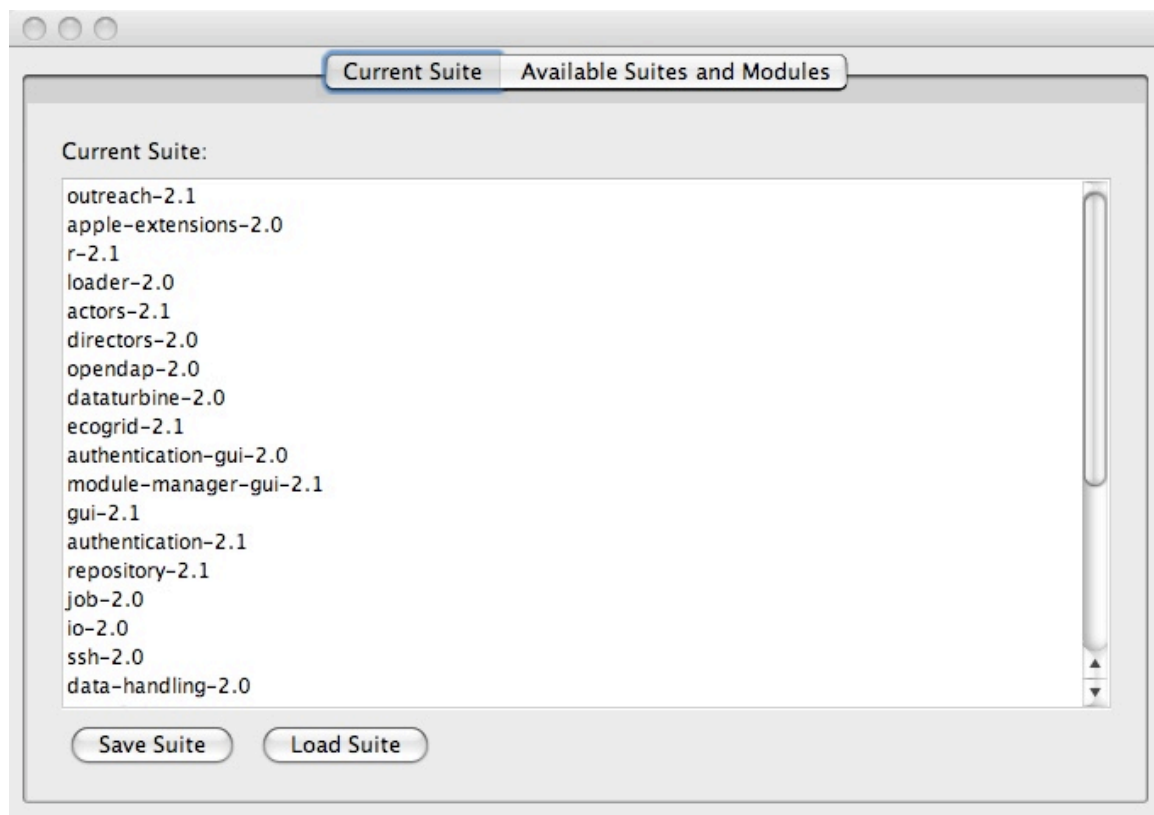

First, there is the Current Suite tab. A suite is simply a list of modules where the order is significant. The current suite is the list of modules that make up the instance of Kepler

you are currently running. Besides providing information on the current suite, the current suite tab has two functions: (1) saving the current suite to file and (2) loading a new suite from file. The intent is to enable you to share your environment with colleagues. If you are working in a particular environment and you want to allow a colleague to synchronize their environment with yours, you could simply save your current suite, email it or otherwise transmit the file to them, and when they load it they would end up working in the same environment, including the download of any modules if necessary. Please note that if you load a preexisting suite, Kepler will restart.

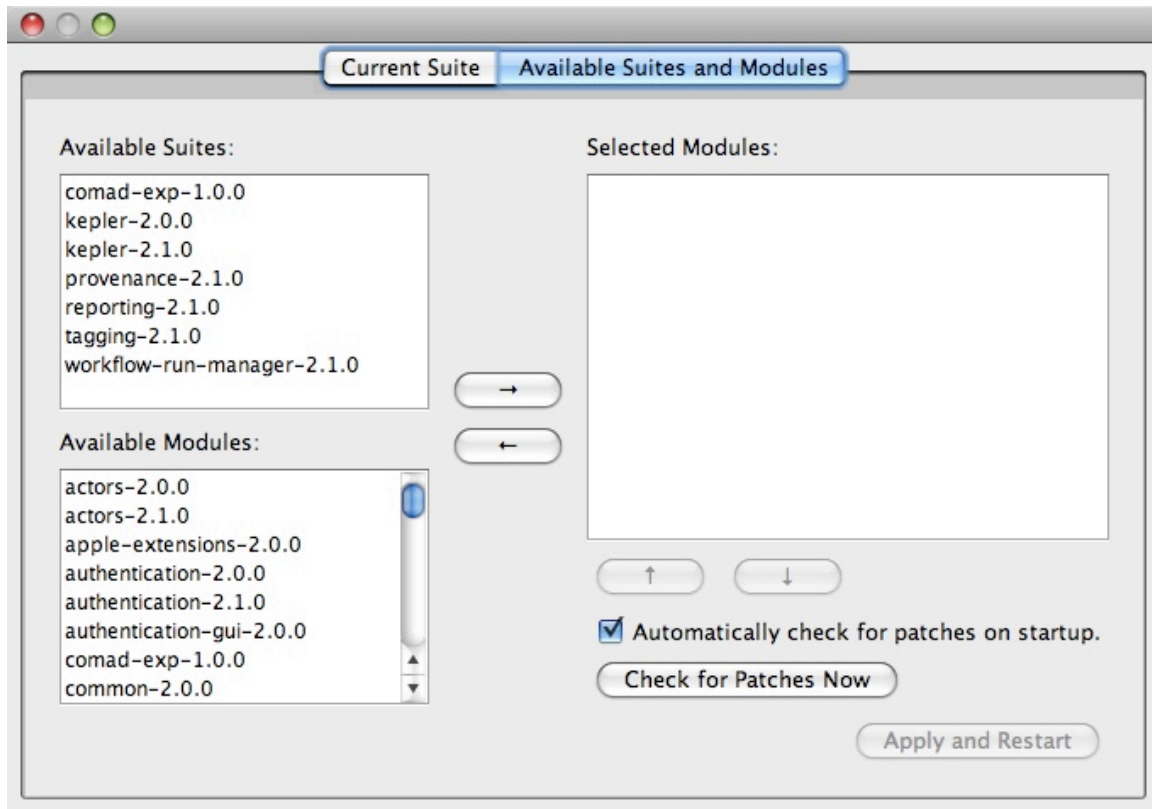

The second tab is the Available Suites and Modules panel. Here there are three lists, a list of all available suites, all available modules, and selected suites and modules. Only published modules and suites are displayed. Developers working with unpublished modules are expected to use the build system.

The use of this panel is relatively simple. A typical user will simply select one of the available suites and then click “Apply and Restart”.

The capabilities here are more advanced however. For very advanced users, it is possible to mix and match suites and modules. However, mixing and matching modules and suites, as opposed to selecting a single suite should not be done by casual users unless specifically instructed, since such mixing and matching can have unpredictable

consequences. For more advanced users/developers, the selected modules list is essentially like `modules.txt`, which is described in the developer documentation on the Kepler website.

11.2 Developing Modules

If you want to add non-actor functionality to Kepler, you will need to develop your own modules. To learn how to do that, please refer to the Build System Instructions at the Kepler website (<https://dev.kepler-project.org/developers>).

Click on the “Build System Instructions” link and then the “Making Your Own Modules” link in the table of contents.

10. Appendix C: Using R in Kepler

The Kepler library contains a number of useful actors that interface with the [R](#) environment, accessing its powerful statistical and data processing tools and integrating that functionality into workflows.

Kepler's *RExpression* actor inserts R commands and scripts into workflows, making it easy to use the data manipulation and statistical functions of R. In addition, a number of customized R actors designed to perform specific functions (creating a bar or box plot, for example) are included in the Kepler library. A search for "RExpression" in the Components tab will return all R-related actors.

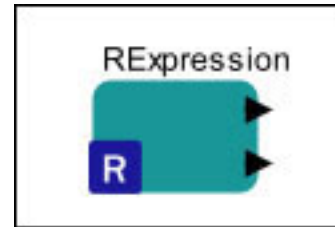

The RExpression actor icon

To implement any of the RExpression actors, R must be installed on the computer running the Kepler application.

C.1 Installing R

R is included with the Kepler installer for Windows and the Macintosh, and will be installed automatically with a full Kepler installation. R is not included with the Linux installer. The version of R included with the Kepler Version 1.0.0 installer is 2.6.2. R is open-source and thus can be freely downloaded and used at no cost.

If R is installed with Kepler, it should not interfere with a previously installed version of R except when one launches R from the command line (by entering 'R'). The Kepler installer updates your system so that the new version of R will be launched from the command line. Existing shortcuts will still open the previously installed R application.

R can be freely downloaded from links on the R Project web site (<http://www.r-project.org>). Follow the instructions provided for installation. In addition (under the Windows operating system), the R 'bin' directory must be added to the PATH variable on the host computer. To test if the installation is correct, open a command/terminal window and type the command 'R'. The command should startup the R environment and alert the user that R has been started.

C.2 A Brief Overview of R

R is open source software for statistical computing, data manipulation, and graphics. Based on work originally carried out at Bell Labs, R is part of the GNU project. The software provides a wide variety of statistical (linear and nonlinear

modeling, classical statistical tests, time-series analysis, classification, clustering, etc) and graphical techniques (*Figure C.1*), and is highly extensible.⁶³

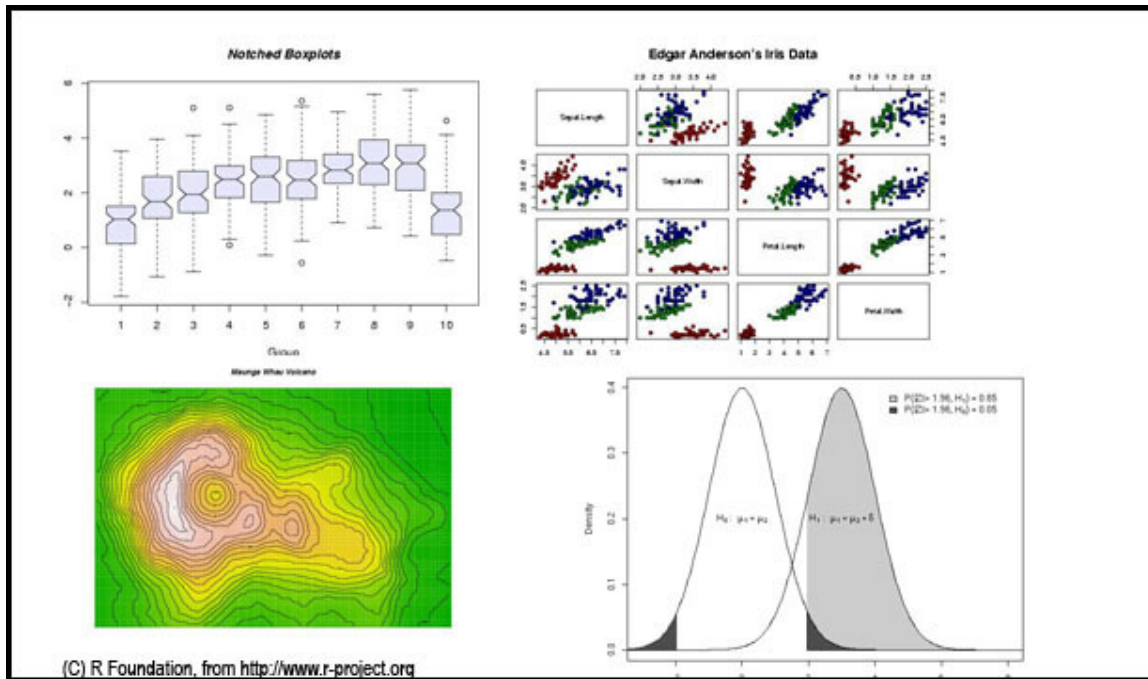

Figure C.1: Examples of graphics generated with R

The R language has many similarities to the Kepler expression language, with the added advantage that many detailed statistical operations and data manipulation routines already exist in R. In addition to performing a wide variety of statistical tests and analyses, R can create sophisticated graphic displays with only a few lines of script (*Figure C.2*).

⁶³ R Project website, <http://www.r-project.org/>

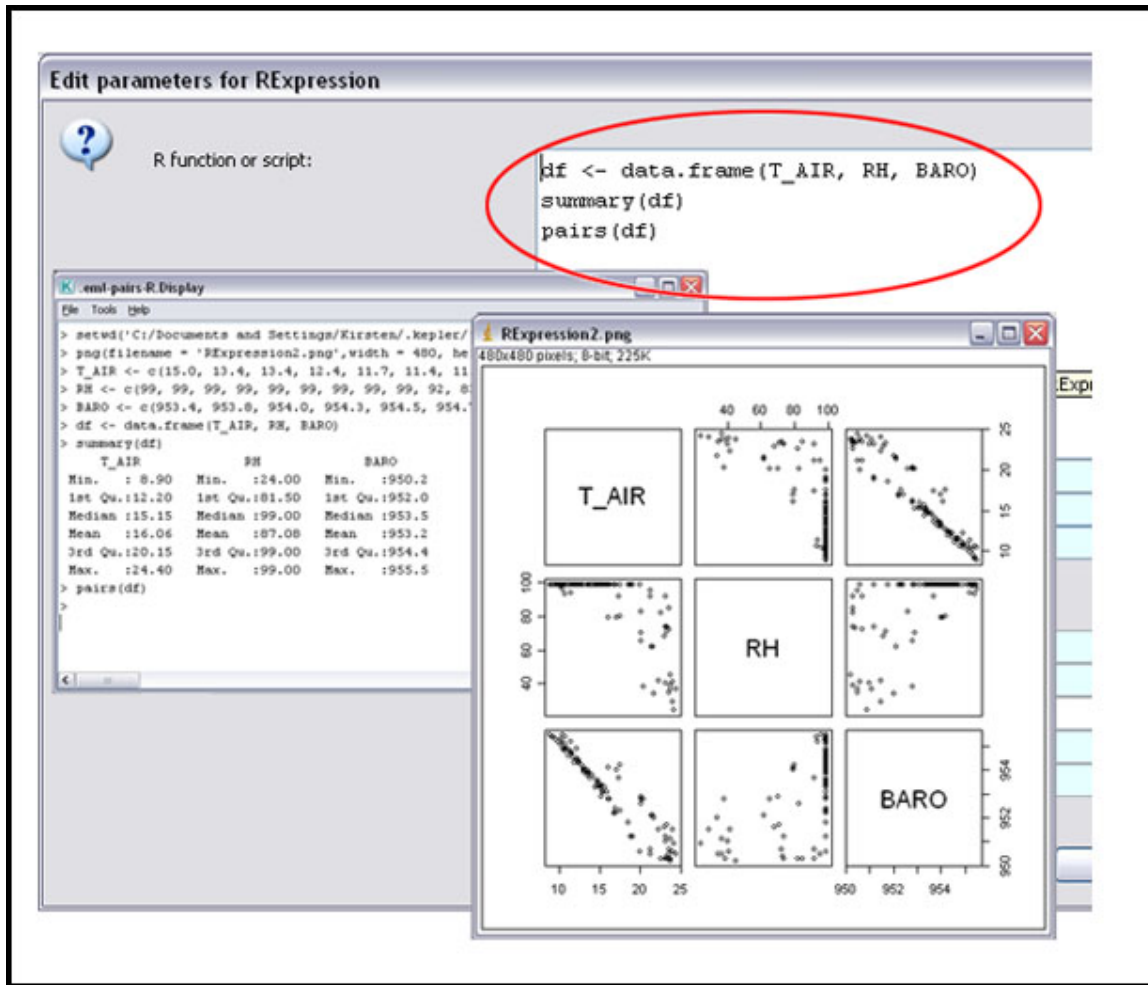

Figure C.2. A three-line R script can read a data table, plot all combinations of column data, and summarize the data.

The R language emphasizes operations on “whole objects” (e.g., vectors, matrices, and tables) rather than on individual elements. This emphasis eliminates many explicit looping statements. We will take a closer look at R data objects in the next section.

R functions, which are often the building blocks of R-scripts, operate on the contents of data objects. See Section 2.2 for more information.

C.2.1 Data Objects

R objects are specialized structures that facilitate high-level manipulation of information. All R objects are derived from several basic types. The most basic kind of R data object is the *vector*, which is a collection of elements that all have the same type (mode). For example, $\{1,2,3,4,5\}$ is a vector with a length of five and a mode of "numeric." Other modes are complex, logical, character, or raw. A second basic R data object is the *list*. A

list is also a collection of elements, but its elements may be of different types (in fact, each element can be any kind of R object, including another list).

Numerous other types of objects are derived from these basic types. Some examples of objects commonly used during data analysis include:

Factor	A special vector storing discrete categorical values
Array	A vector with a dimension attribute
Matrix	An array with two or more dimensions
Data Frame	A data table (formally, a list of vectors all of the same length)

Table C.1: R data objects

For more information about R data objects, please see [An Introduction to R](#) by W.N. Venables, D.M. Smith and the R Development Core Team. In Section 4, we will look at examples of several of these data objects in Kepler/R workflows.

C.2.2 Functions

An R function is a self-contained routine that accepts input arguments and returns a single R object. The base R system includes many useful functions that can be called interactively or via scripts. For example, the `read.csv()` function reads a comma-delimited ASCII file and creates a data frame object from it; `write.table()` writes a data frame object to an ASCII text file; and the `hist()` function produces a histogram. For a useful list of R functions, please see [These are a Few of My Favorite R Things](#).

A rich set of additional functionality is available via freely available add-on packages contributed by the R user community. The primary source of such packages is the [Comprehensive R Archive Network](#). Users can also write new functions and modify existing functions as needed. For more information about writing new functions, please see [An Introduction to R](#) by W.N. Venables, D.M. Smith and the R Development Core Team.

C.2.3 Further Resources

Please see the NCEAS [R Programming Language Resource Center](#) for a collection of useful R resources including information describing specific R add-on packages, advanced geospatial and geostatistical analysis methods that incorporate R, a list of questions (with answers) to common introductory R questions, information about R spatial analysis tools and many new R packages, and dozens of R tutorials.

For a short reference to R functions see [The R Reference Card](#) by Tom Short and for many tips on R usage, see Paul Johnson's [R tips page](#).

C.3 The RExpression Actor

To get started using R in Kepler, drag-and-drop the *RExpression* actor onto the Workflow canvas (*Figure C.3*). A search for "RExpression" in the Components tab will return all R-related actors. The *RExpression* actor is under the 'General Purpose' heading. Note that all R actors are represented by the same icon: a teal rectangle with a blue square/white R in the bottom left corner. Once the *RExpression* actor is on the Workflow canvas, it can be customized with additional ports and a user-defined R-script.

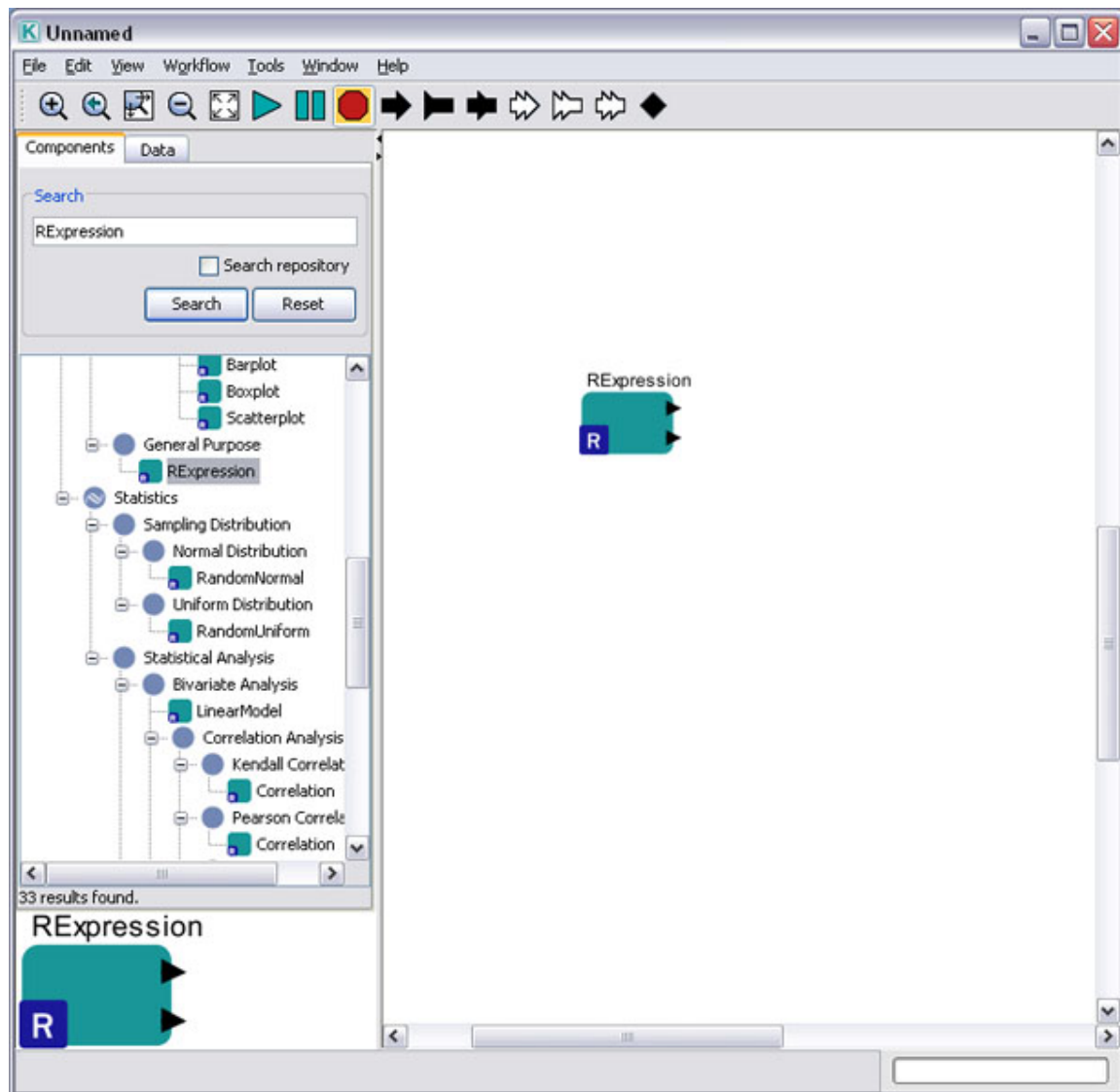

Figure C.3: The *RExpression* actor.

C.3.1 Inputs

The *RExpression* actor is customized in two basic ways: via new ports, which can receive data to be processed by the R-script; or via parameters, which are used to specify an R-script and settings that relate to the R workspace (the working directory, graphics format, etc). In the next sections, we will look more closely at both ports and parameters.

C.3.1.1 Input Ports

Input ports can (and very often must) be added to the *RExpression* actor to receive data that will be processed by the R-script. To add an input port, right-click the *RExpression* actor and select Configure Ports from the drop-down menu (*Figure C.4*).

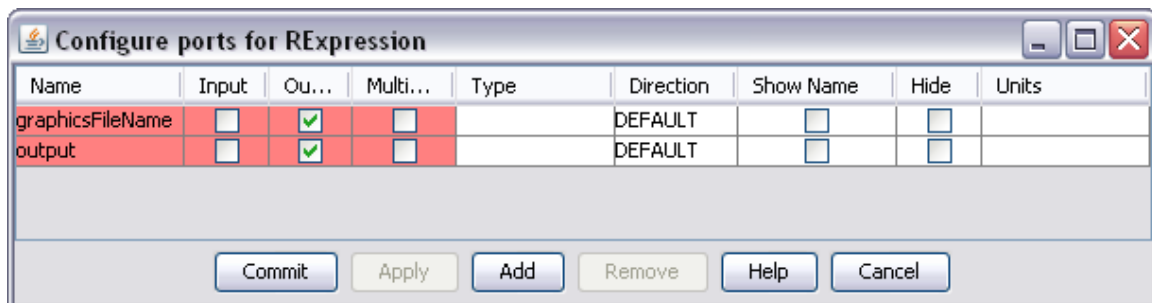

Figure C.4: Configuring the ports of the *RExpression* actor. Ports that cannot be modified are noted with a pink highlight.

To add a new port, click the Add button and then customize the new port. Every port must have a name, which can be customized by double-clicking the field in the Name column and typing a name. The port name will be used as the name of the corresponding R data object. For example, if an input port called `values` accepts a data array, the R-script will reference the array data object by the name `values`.

When input ports are configured as multiports, all tokens received on that multiport are added to a list object in R. The list name corresponds to the name of the R actor's input port. The list order is determined by the order in which connections are added to the multiport. For an example, please see Section 4.1.1.5

The *RExpression* actor in *Figure C.5* has two user-defined input ports named `aaa` and `bbb`. Two *Expression* actors pass arrays to these ports, and the *RExpression* actor constructs R vectors (`aaa` and `bbb`) from this input by applying the `c()` function: `aaa` is `{1,2,3}` and `bbb` is `{4,5,6}`, the values passed through the correspondingly named

ports. The R script has been set to `aaa+bbb`, and the result is the sum of the R vectors:
5 7 9.

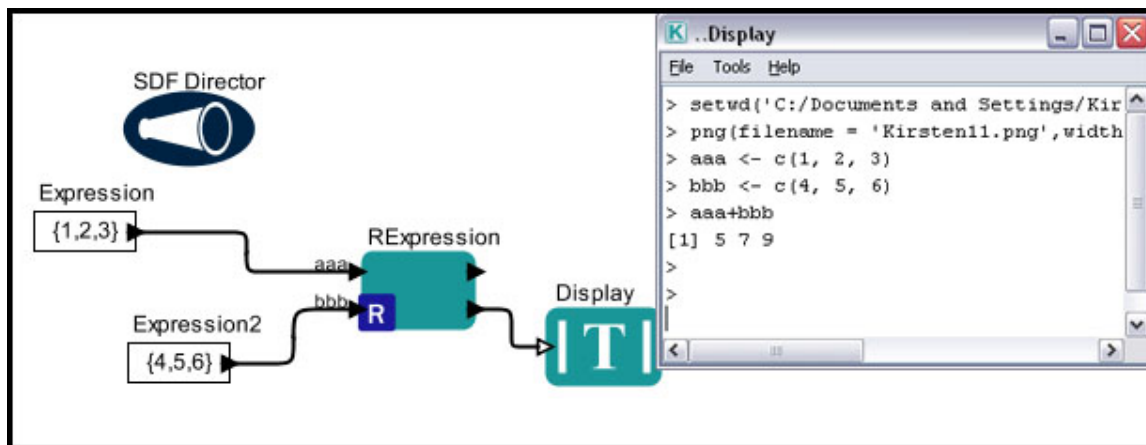

Figure C.5: Two user-defined ports (aaa and bbb) have been added to an *RExpression* actor.

The Display window in *Figure 5* contains the text output that R generates. Additional output ports can be added to output R-script results.

C.3.1.2 Parameters (the R-script and more)

The R script or function that the *RExpression* actor runs is specified by the actor parameters. To view or change the R script, double-click the actor.

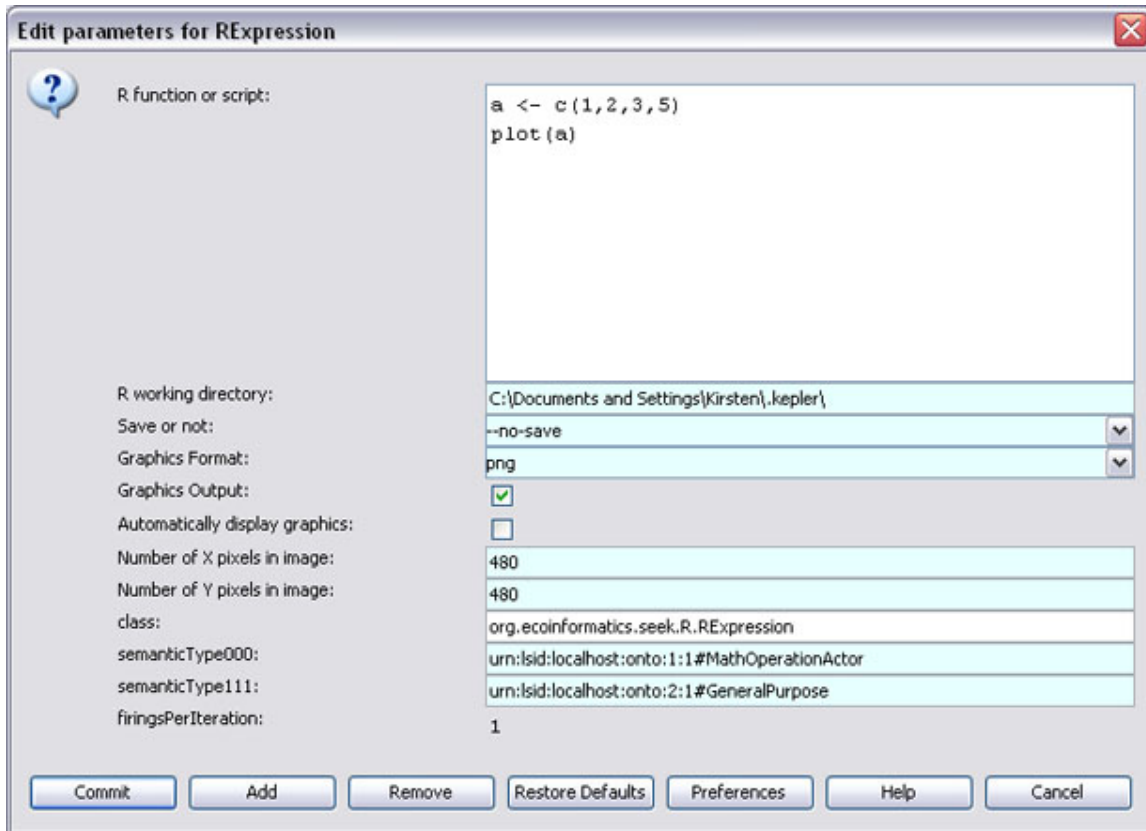

Figure C.6: The default parameters of the *RExpression* actor.

The default R script, shown in *Figure C.6* creates and saves a plot of an array of values {1,2,3,5}. To use another R-script, simply replace the default script with the desired one. The additional *RExpression* parameters are used to customize the behavior of the actor (*Table C.2*).

<i>RExpression</i> parameter	Parameter use
directory	The 'R' working directory (the Kepler cache by default).
Save or not	Specify whether or not to save the R workspace when R is closed; set to '--save' to retrieve the workspace later in a workflow with another R actor.
Graphics Format	The graphics output format. Currently the actor supports either *.pdf or *.png.
Graphics Output	Specify whether or not to send graphics to a graphics output port. By default, the actor will send data to a graphics output port.
Automatically display graphics	Select to automatically display the plot once the actor has generated it. Note that if this option is selected, the output file will always be in PDF format, regardless of the value selected as the Graphics Format setting.

Number of X pixels in image	The width of the output graphic in pixels.
Number of Y pixels in image	The height of the output graphic in pixels.

Table C.2: *RExpression* actor parameters and their use.

C.3.2 Outputs

By default, the *RExpression* actor creates an output port for a graphical representation of results as well a copy of the text output that R generates. Users can add additional output ports for outputting results generated by the script.

C.3.2.1 R-Text

The R text consists of the actor's communications with R to run the R function or script as well as the values and statistical outputs. *Figure C.7* displays a very simple R workflow that shows the text and graphical display of an *RExpression* actor with its default settings.

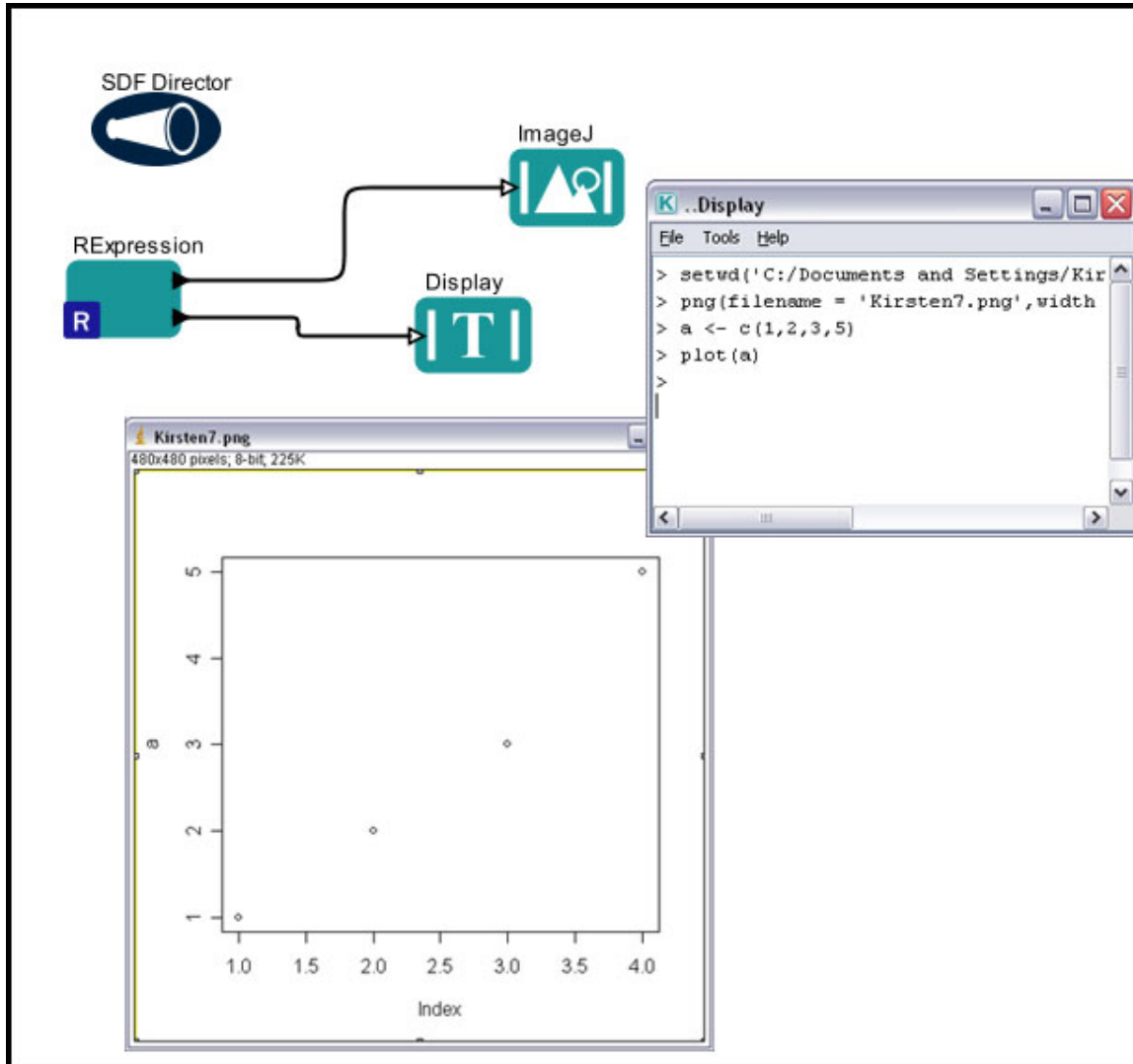

Figure C.7: The default settings of the *RExpression* actor. By default, the actor creates a plot of the values (1,2,3,5).

The first two lines in the text display window in the upper right corner of *Figure 7* (`'setwd...'` and `'png...'`) are setup commands for R that are automatically added by the actor. The last two lines of the display are exactly what would appear if one were running the R system from the command line:

```
a <-c(1,2,3,5)
plot(a)
```

To "hide" the R-text output, simply leave the port unconnected.

C.3.2.2 Graphical Output

Some R functions ‘draw’ to a graphical display device. The *RExpression* actor automatically creates a display file and sends the name of this file to the `graphicsFileName` port for use by a display actor. (If no functions that create graphics are called this file will be blank.) *Figure C.8* shows a workflow that uses an *RExpression* actor to read two arrays, add them, and output a bar plot of the result. The R-script used by the *RExpression* actor consists of two lines:

```
ccc <- aaa + bbb
barplot(ccc)
```

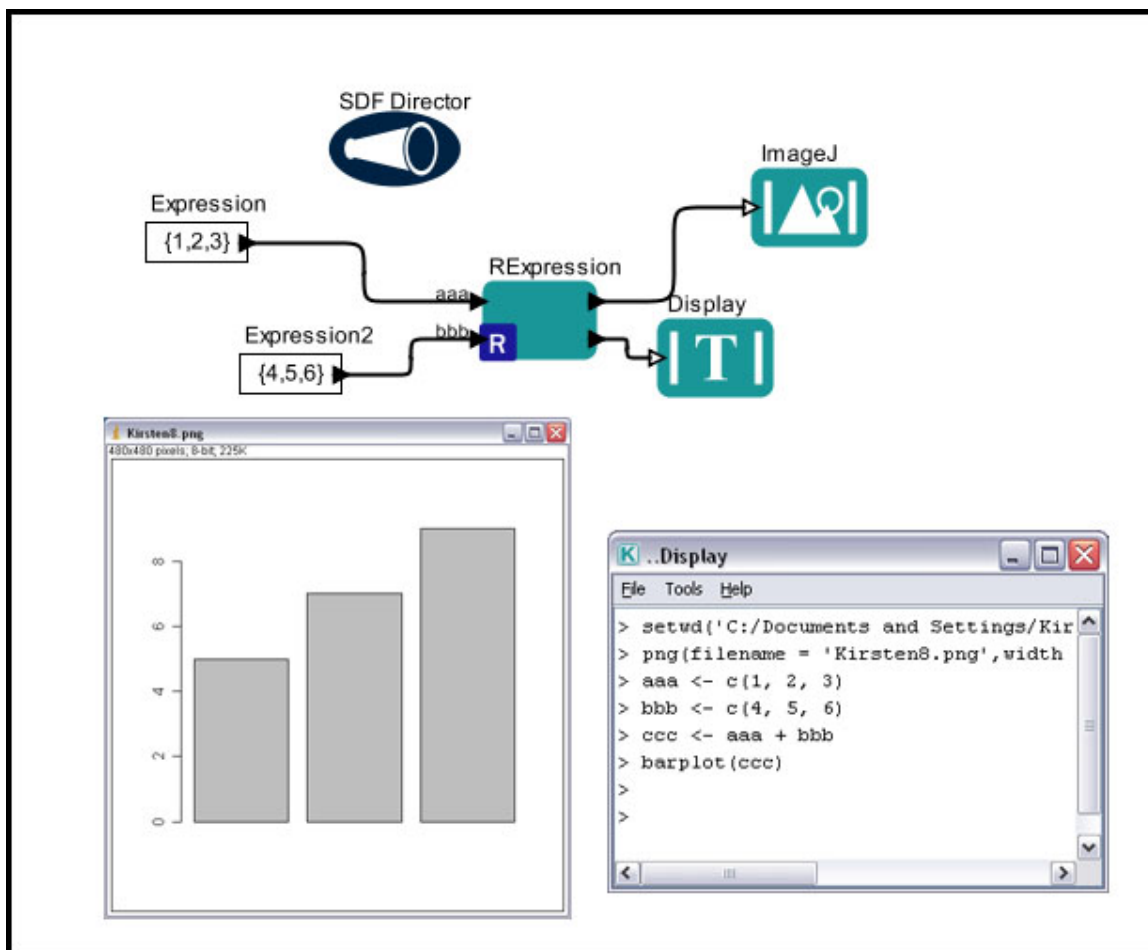

Figure C.8: An example of an *RExpression* workflow used to create a barplot.

In the above workflow, the barplot is saved as a `.png` file (the default). The *RExpression* actor can also generate and save a `.pdf` file--set the desired output type with the `GraphicsFormat` parameter. The dimensions of the graphic can be customized with the `NumberOfXPixelsInImage` and `NumberOfYPixelsInImage` parameters. By default, the graphic is 480x480 pixels. Generated graphics files are saved to the R

working directory, which by default is the Kepler cache (e.g., C:\Documents and Settings\\.kepler\).

The *RExpression* actor can also be set to display graphics automatically. Select the `AutomaticallyDisplayGraphics` parameter to open graphical results in your system's default viewing application. If this parameter is selected, the output file will always be in PDF format, regardless of the value of the `GraphicsFormat` parameter, as users are more likely to have a PDF viewing application than a PNG one.

C.3.2.3 User-Defined Output

To output results generated by the R-script (in addition to a graphic and R-text), add additional output ports to the *RExpression* actor. The *RExpression* actor in *Figure C.9* has been modified with a user-defined output port to output the sum of two vectors (`ccc`). The R-script used by the *RExpression* actor is:

```
ccc <- aaa + bbb
barplot(ccc)
```

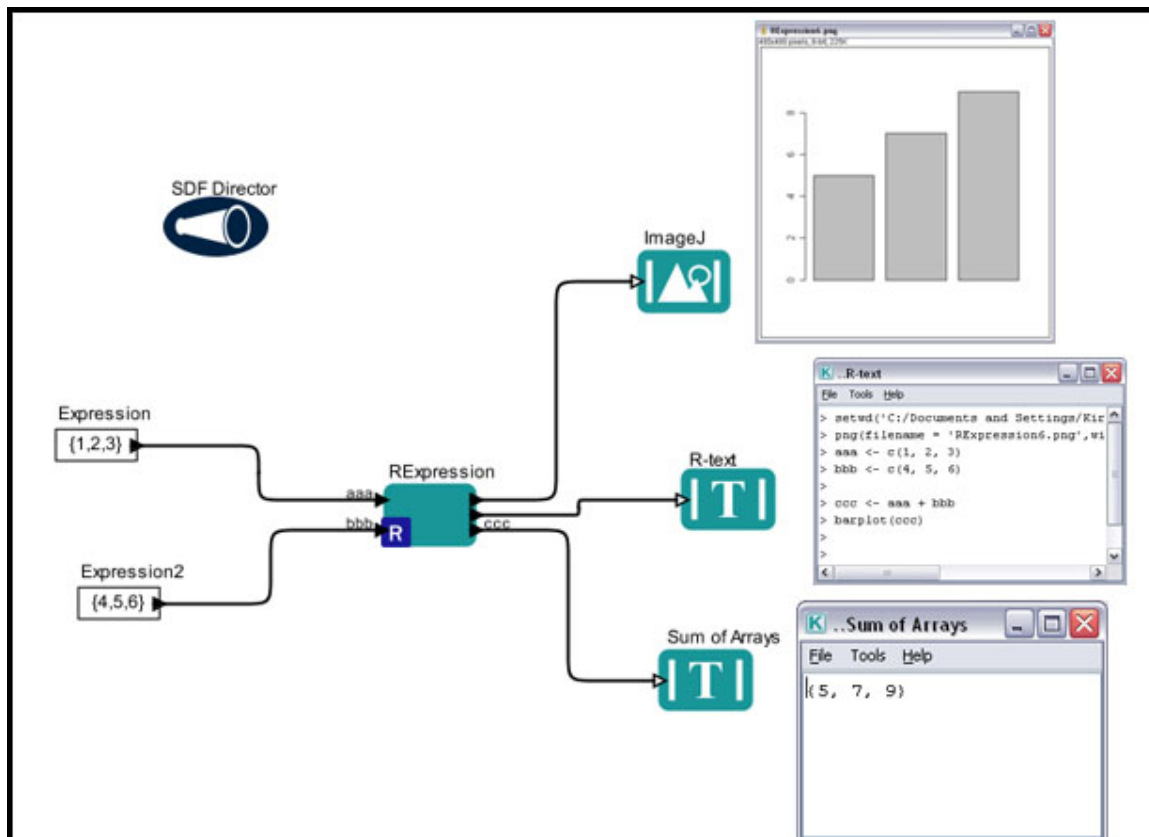

Figure C.9: Adding an output port (`ccc`) to the *RExpression* actor.

The output port name must exactly match the name of the corresponding R data object. In the workflow in *Figure C.9*, the R-script defines the sum of the vectors as `ccc`. The output port called `ccc` broadcasts that value (`{5, 7, 9}`). Note: When an output port is configured as a multiport, all of the actors connected to that multiport are sent the token.

C.4 Handling Data

R can process a number of different types of data objects (vectors, data frames, etc). How those objects are best input to the *RExpression* actor depends to some extent on the format of the data itself. Does the data set use metadata? Is it contained in an Excel spreadsheet? Or is it a simple array of numbers? In the next sections, we will look at examples that demonstrate various techniques for inputting data to an *RExpression* actor. We will also look at how the *RExpression* outputs different types of data objects.

C.4.1 Inputting Data

Whether you are working with data arrays, records, R data frames, or local data sets saved as tab- or comma-delimited text files, data can be input into an *RExpression* actor via user-defined input ports. If the data is described by Ecological Metadata Language (EML), an *EML2Dataset* actor can be used to format the data appropriately.

C.4.1.1 EML (Ecological Metadata Language) Data Sets

Datasets that use EML can be read and output in a variety of ways by the *EML2Dataset* actor. In the next few examples, we will look at a meteorological data set (*Datos Meteorologicos*) described by EML and stored on the EarthGrid. To download and explore this dataset, select the Data tab and search for "Datos Meteorologicos" (or a portion of the name, such as 'Datos'). When the data are dragged onto the Workflow canvas, Kepler will create an *EML2Dataset* actor (*Figure C.10*) named after the dataset and used to access and output the data in a variety of different formats.

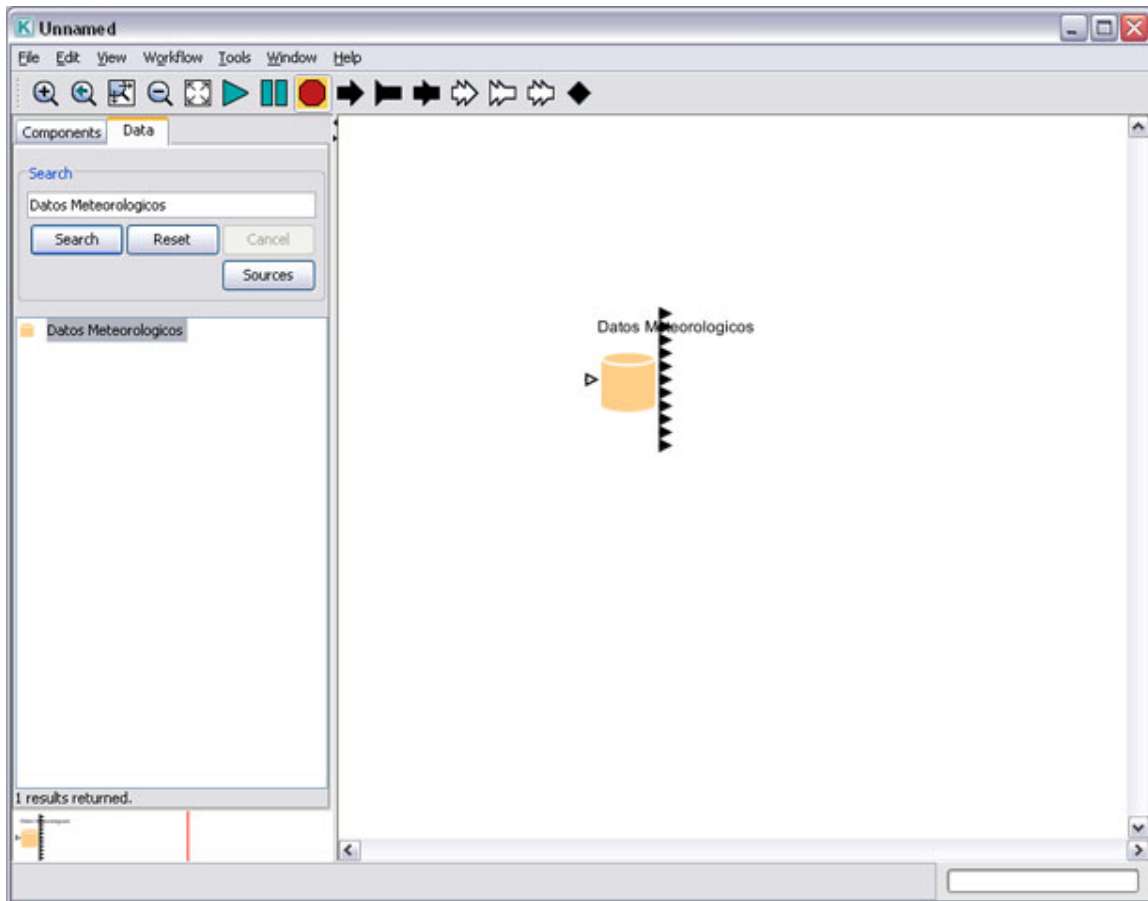

Figure C.10: An EML dataset (Datos Meteorologicos).

By default, the *EML2Dataset* actor downloads the data to the Kepler cache (if the data is not already available there) and creates an output port for each column of data. Mouse over each port to see the name and type of the data output.

To learn more about the data set, right-click the actor and select Get Metadata from the drop-down menu. The metadata contains information about the data (the owner and structure) as well as the type and measurement of the data included in the set.

The *EML2Dataset* actor can be customized to output data in a variety of ways: as field, table, row, byte-array, un-compressed file name, cache file name, column vector, or column-based record. We'll look at examples of how these different formats can be used with the *RExpression* actor in the next few sections.

C.4.1.1.1 Example One: Selecting and Using Columns of Data (Column Vectors)

The workflow discussed in this section can be found under `KeplerData/workflows/module/r-2.X.Y/demos/R/eml-pairs-R.xml`

The workflow in *Figure C.11* uses an R-script to create a pairs graph of three columns of data (air temperature, relative humidity, and barometric pressure) from a meteorological

data set described by EML. The data are input to the *R*Expression actor as arrays of column values (column vectors).

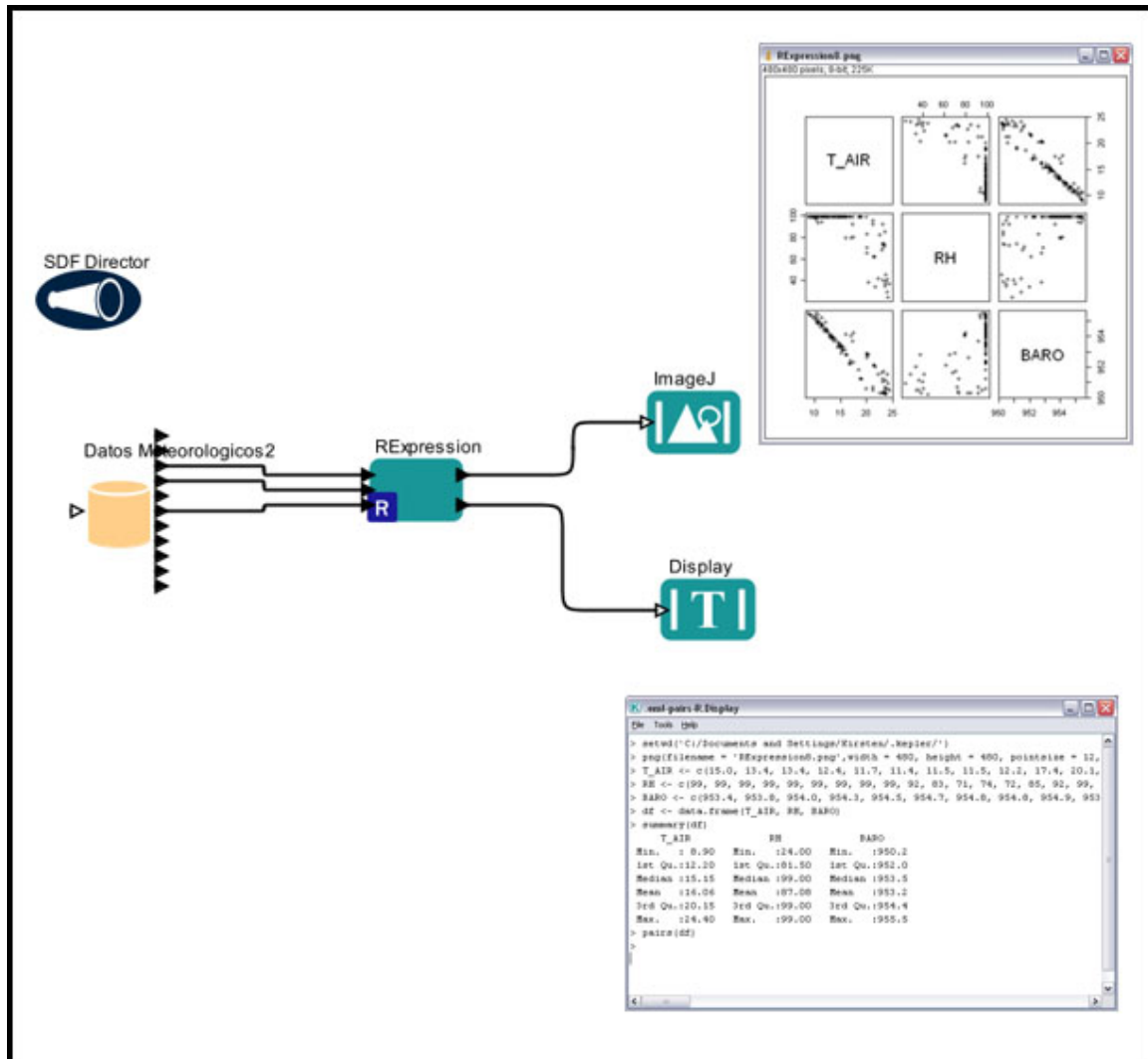

Figure C.11: Using column vectors with the *R*Expression actor.

The *R*Expression actor in Figure C.11 has three user-defined input ports: T_AIR, RH, and BARO, which receive the temperature, relative humidity, and barometric pressure data, respectively. These data are passed in the form of column vectors. To output the data in this format, double-click the *Datos Meteorologicos2* actor and select *As Column Vector* as the value of the *Data Output Format* parameter (Figure C.12).

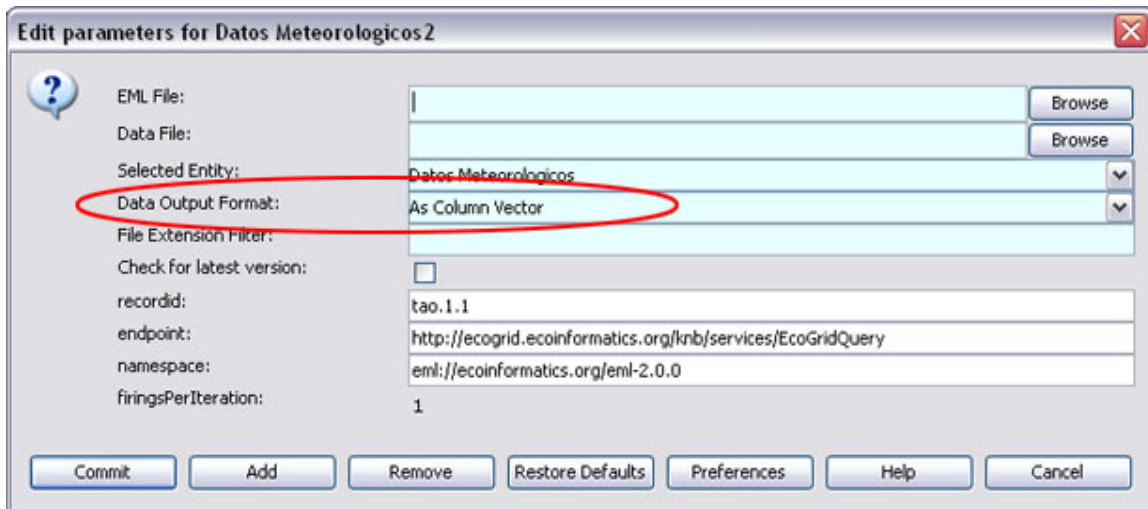

Figure C.12: Setting *As Column Vector* as the data output format.

The *RExpression* actor uses a three-line R-script to combine the vectors into a data frame (a collection of R data objects), summarize the table, and create a pairs-graph of the values:

```
df <- data.frame(T_AIR, RH, BARO)
summary(df)
pairs(df)
```

An *ImageJ* actor displays the graph (a .png file saved to the R working directory), and a *Display* actor displays the text output by R.

C.4.1.1.2 Example Two: Selecting and Using an Entire Data Set (Column-Based Records)

The workflow discussed in this section can be found under KeplerData/workflows/module/r-2.X.Y/demos/R/eml_Table_as_Record.xml

The workflow in *Figure C.13* uses an R-script to create a pairs graph of a column-based record that contains all columns of data (date, time, air temperature, relative humidity, dew point, barometric pressure, wind direction, wind speed, rainfall, solar radiation, and solar radiation accumulation) from a meteorological data set described by EML. The data are fed to the *RExpression* actor as a single column-based record. This data format is specified by the *EML2Dataset* actor (*Datos Meteorologicos2*).

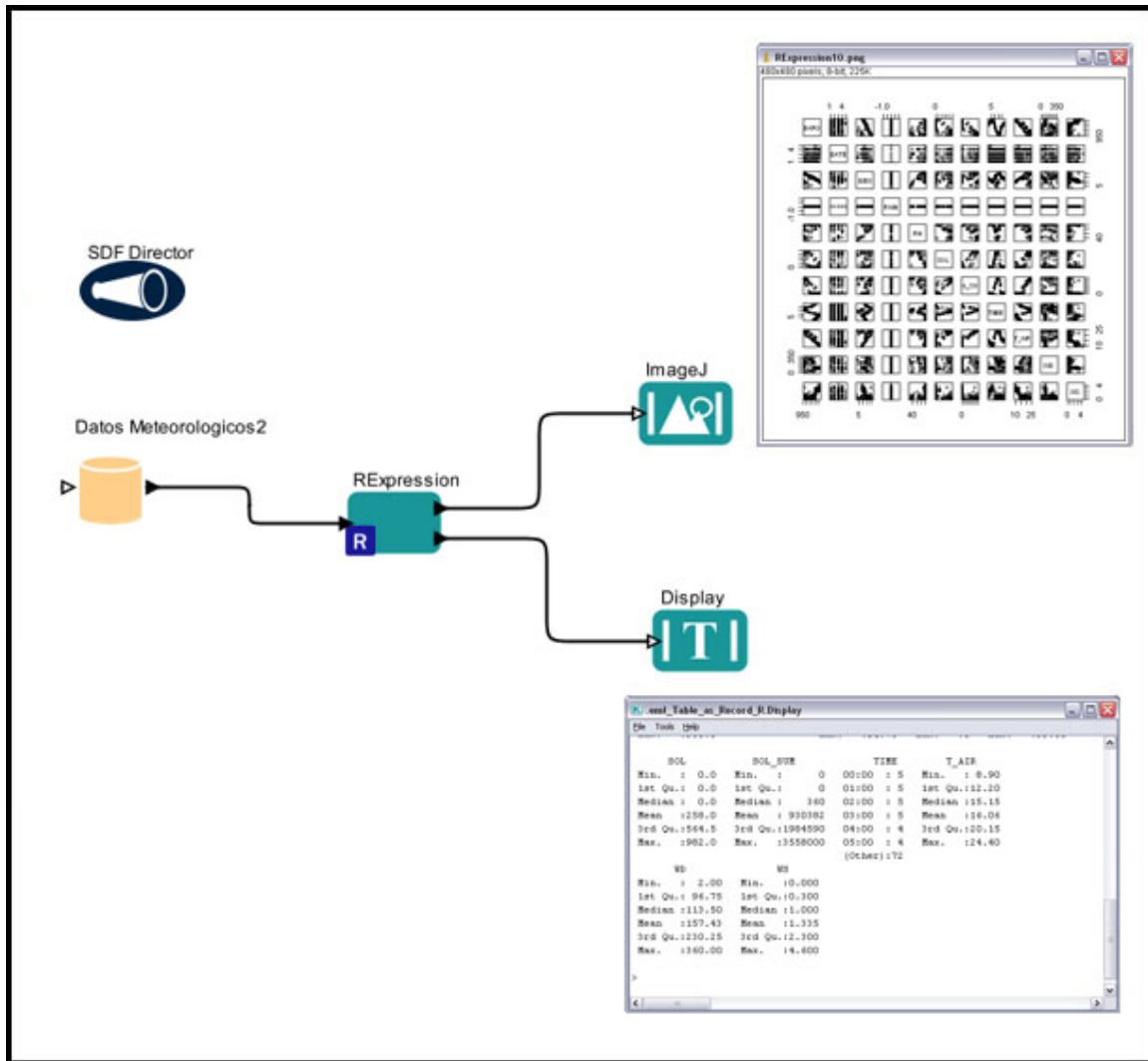

Figure C.13: Using column-based records with the *RExpression* actor.

The *RExpression* actor in *Figure C.13* has a single user-defined input port (*df*), which receives an entire data set as a column-based record that is translated into an R data frame object. Double-click the *Datos Meteorologicos2* actor and select *As ColumnBased Record* as the value of the *Data Output Format* parameter to output the data in the required format (*Figure C.14*).

A column-based record consists of named elements and their values. In Kepler, records are specified between curly braces. For example, $\{\text{BARO} = \{953.4, 953.8, 954.0\}, \text{DATE} = \{"01/01/01", "01/01/01", "01/01/01"\}, \text{DEW} = \{14.5, 12.8, 12.8\}\}$ is a record with three elements named BARO, DATE, and DEW.

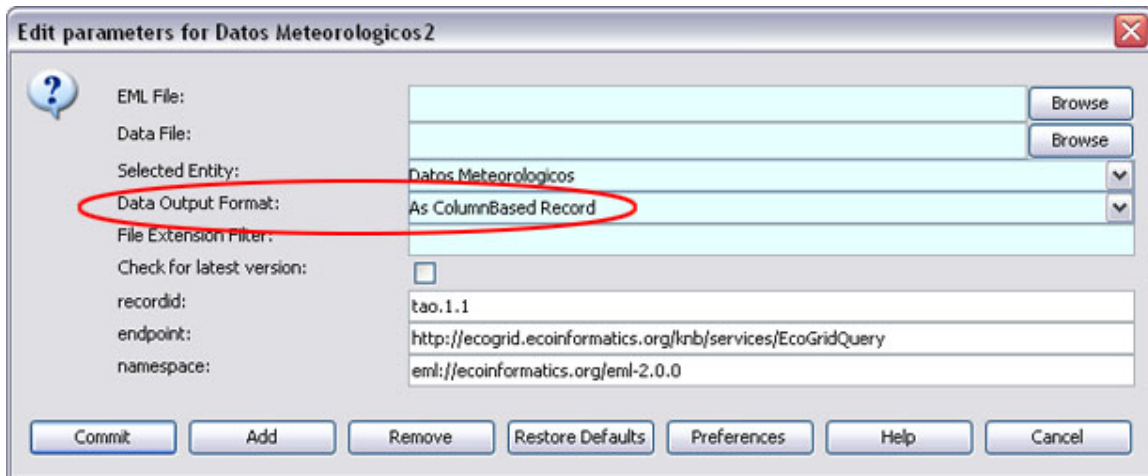

Figure C.14: Setting As ColumnBased Record as the output format for the data.

The *RExpression* actor uses a two-line R-script to create a pairs graph of the data and summarize it:

```
pairs(df)
summary(df)
```

An *ImageJ* actor displays the graph (a .png file saved to the R working directory), and a *Display* actor displays the text output by R.

C.4.1.1.3 Example Three: Selecting and Using a Cached Dataset (*read.table* function)

The workflow discussed in this section can be found under KeplerData/workflows/module/r-2.X.Y/demos/R/dataFrame_R.xml

The workflow in *Figure C.15* uses an R-script to create a pairs graph of a meteorological data set described by EML that is saved to the local cache. The location of the cached data set is fed to an *RExpression* actor, which reads the file and uses the *read.table* function to parse the data before creating the pairs graph.

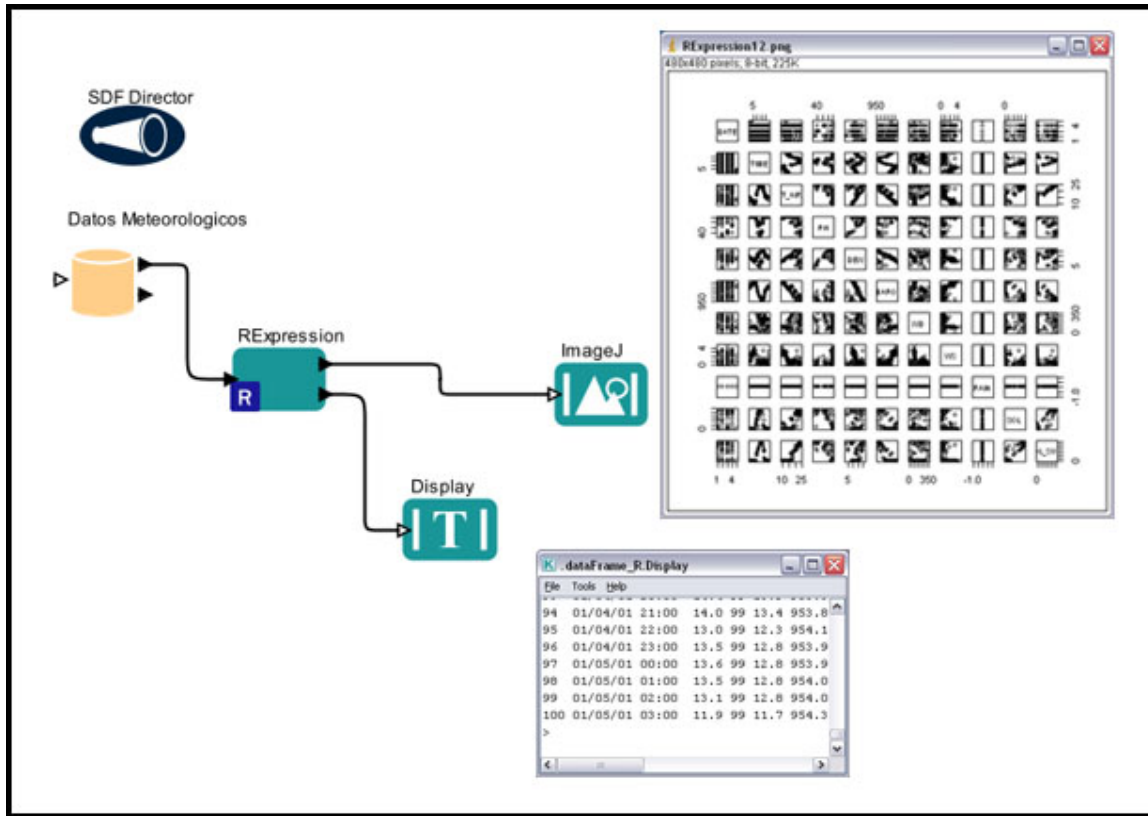

Figure C.15: Using column-based records with the *RExpression* actor.

The *RExpression* actor in *Figure C.15* has a single user-defined input port (*infile*), which receives the location of the cached data set (e.g., `C:\Documents and Settings\username\.kepler\cache\cachedata\urn.lsid.localhost.7a976669.0.0`). To output data in this format, double-click the *Datos Meteorologicos2* actor and select *As Cache File Name* as the value of the *Data Output Format* parameter.

The *RExpression* actor uses an R-script to read the data file, create a data frame object using R's [read.table](#) function, and then create a pairs graph from it.

```
datafile <- infile
df <- read.table(datafile, sep=" ", header=TRUE)
pairs(df)
df
```

An *ImageJ* actor displays the graph (a `.png` file saved to the R working directory), and a *Display* actor displays the text output by R. Note that the data frame is also displayed in the R-text output.

arrayLength parameter for each of the three SequenceToArray actors must be set to 100. (Figure C.17)

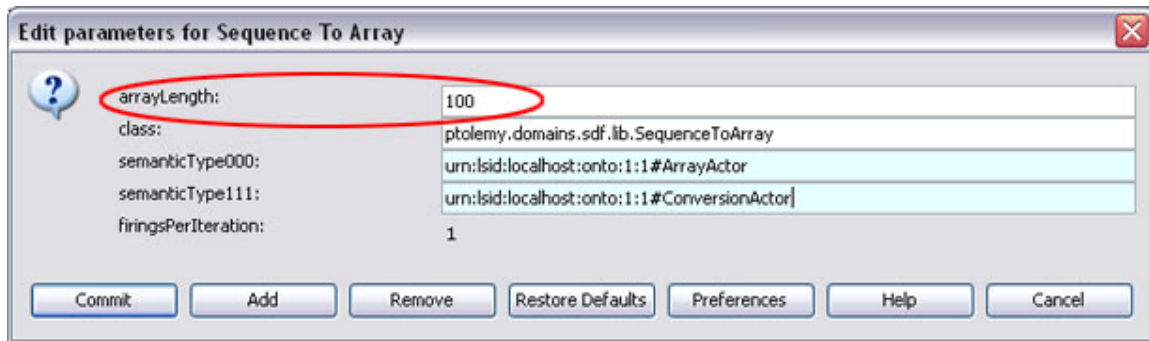

Figure C.17: Specify the length of the array to be created by the *SequenceToArray* actor (i.e., the number of records in the data set).

The number of records in the data set is noted in the metadata. Right-click the *Datos Meteorologicos2* actor and select Get Metadata to view this information (Figure C.18).

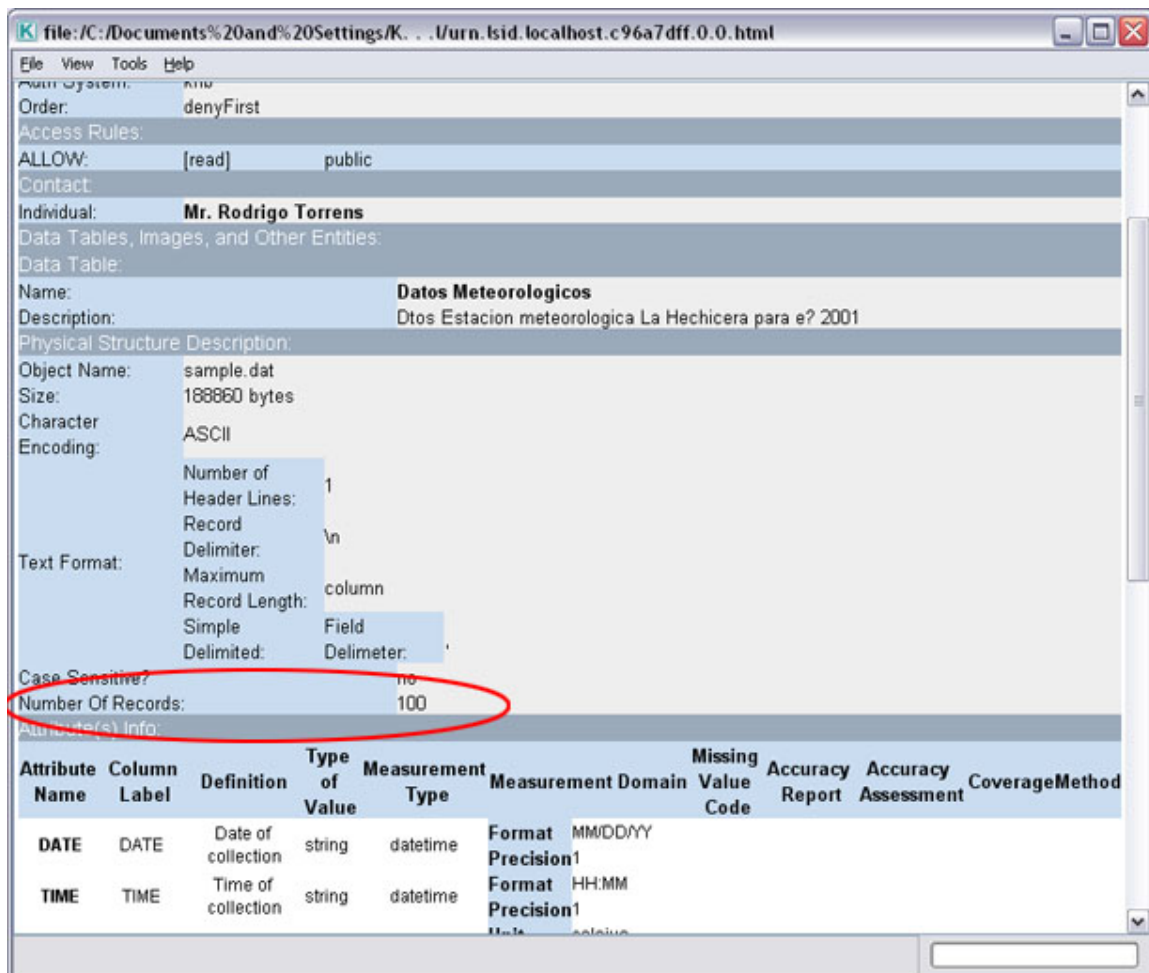

Figure C.18: The number of data records is noted in the data set metadata.

The *RExpression* actor uses a two-line R-script to create a pairs graph and summarize the data:

```
pairs(df)
summary(df)
```

An *ImageJ* actor displays the graph (a .png file saved to the R working directory), and a *Display* actor displays the text output by R.

C.4.1.1.5 Example Five: Using Ports Configured as Multiports

The *UnionAll* RExpression actor in Figure C.19 is configured with a multiport input and output port. All tokens received on the multiport are added to a list object by the *UnionAll* R actor and then output to two R actors (*Pairs* and *Summarize*) for further processing. Note that the multiport output port broadcast the R data to all of the actors it is connected to. The workflow outputs a pairs graph of the data and a summary table.

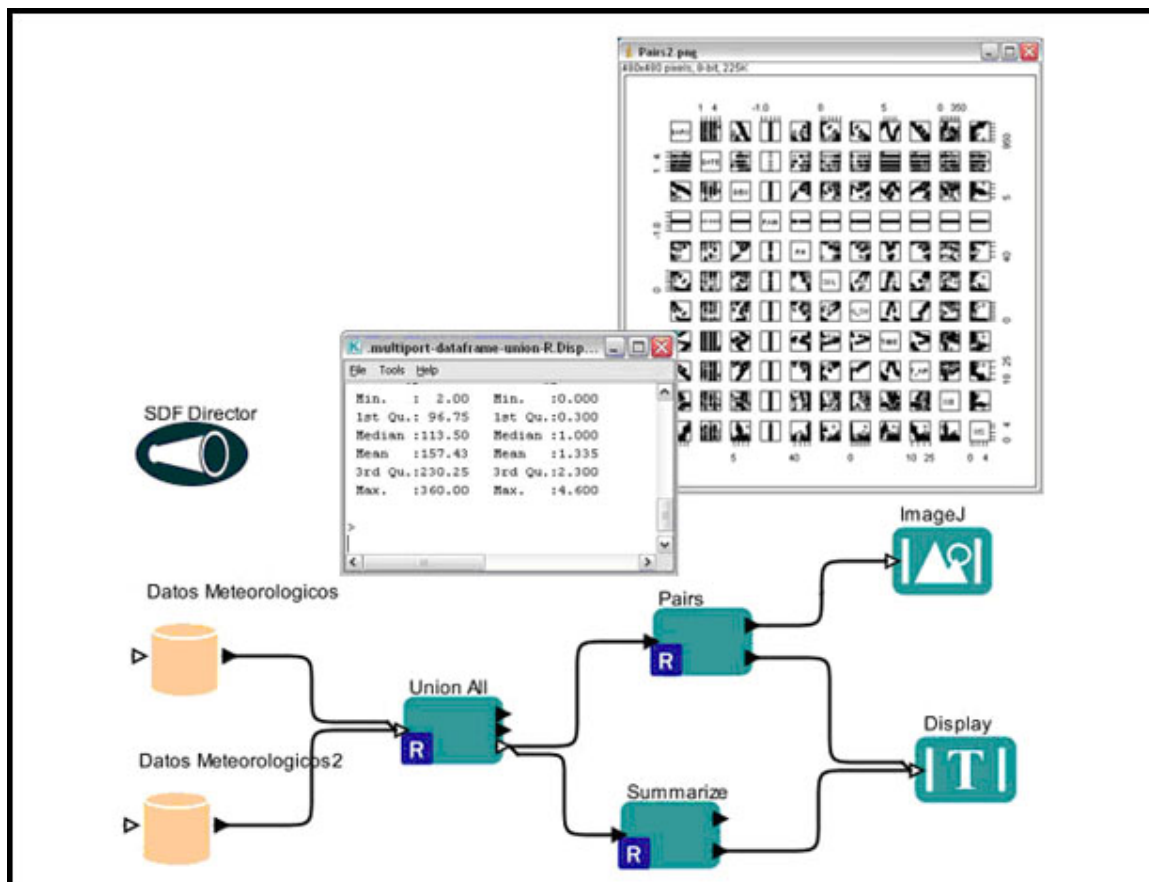

Figure C.19: Using an input port configured as a multiport.

To add and configure a multiport, right-click the actor and select Configure Ports from the drop-down menu. Name the port, select its direction (input or output) and then check the Multiport option (*Figure C.20*).

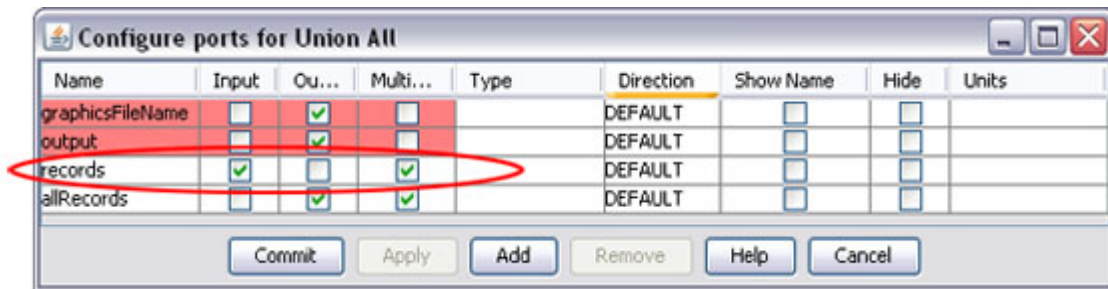

Figure C.20: Using an input port configured as a multiport.

The *UnionAll* actor receives two data sets through its `records` multiport. These data are output by two EML actors set to output data in "As column based record" format. The *RExpression* actor creates a dataframe from each received token and, because the data are received through a multiport, adds the dataframes to an R list object. The *UnionAll* actor uses the following R-script to concatenate the list of received dataframes into a single dataframe:

```
allRecords = do.call( "rbind", records)
```

The `allRecords` dataframe is output by the *UnionAll* actor's `allRecords` multiport output port, which is connected to two downstream R actors: *Pairs* and *Summarize*. The multiport output port broadcast the R data to all of the actors it is connected to, so there is no need to use a relation.

C.4.1.2 Non-EML Data Sets

Data that do not use metadata—Excel spread sheets saved as text files, for example, or the values of an *Expression* or *Constant* actor--can also be used by the *RExpression* actor. In the next sections, we will look at several examples.

C.4.1.2.1 Example Six: Local Text-Based Data Sets (Selecting an Entire Data Set)

The workflow discussed in this section can be found under `KeplerData/workflows/module/r-2.X.Y/demos/R/localFile_to_dataframe_R.xml`

The workflow in *Figure C.21* uses an R-script to (1) read a local text file containing comma-delimited data, (2) create an R data frame with the data, (3) create a pairs graph of the data set, and (4) summarize the data. The location of the data set is input to the *RExpression* actor by an *Expression* actor named *Path to local file*.

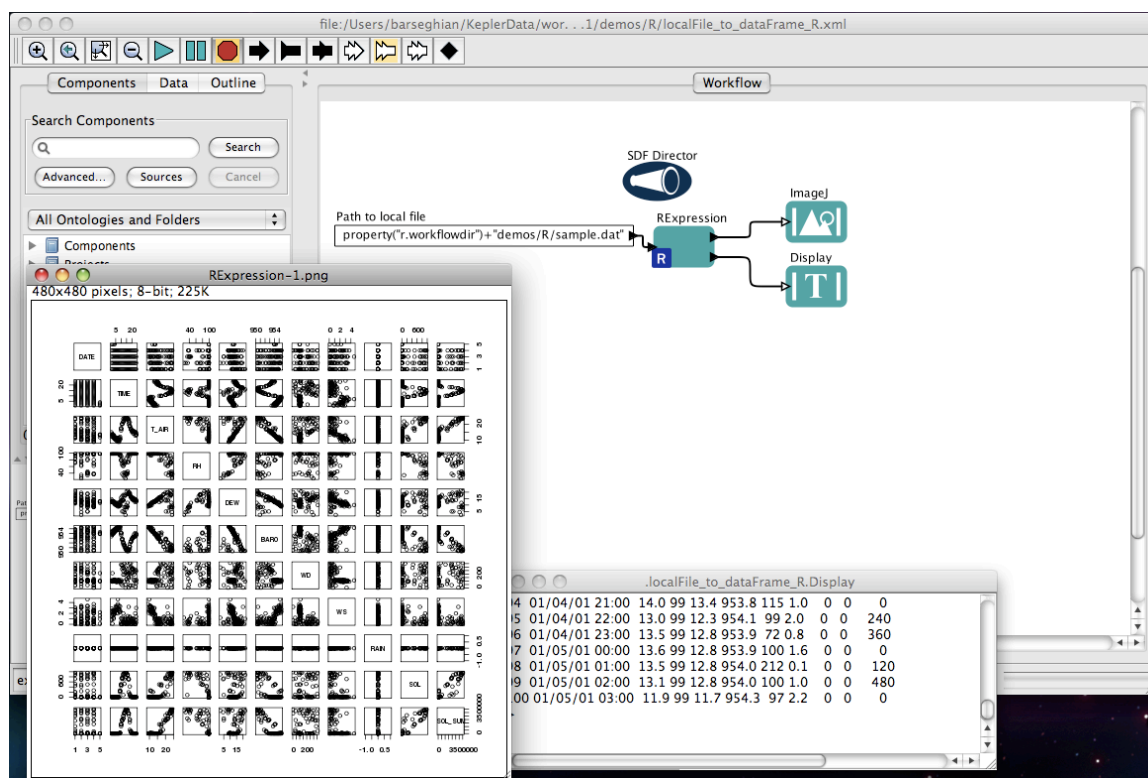

Figure C.21: Using local data sets that do not use metadata with the *RExpression* actor.

The *RExpression* actor in Figure C.21 has a single user-defined input port (`infile`), which receives the location of the local data set: `property("r.workflowdir")+"demos/R/sample.dat"`. The expression `property("r.workflowdir")` returns the path to the R module's workflow area. Note the use of `'/'` rather than `'\'` in the expression, even on Windows platform.

The *RExpression* actor uses an R-script to read the data file, create a data frame object using R's [read.table](#) function, and then a pairs graph of the data set:

```
datafile <- infile
df <- read.table(datafile, sep=",", header=TRUE)
pairs(df)
df
```

An *ImageJ* actor is used to display the pairs graph (a `.png` file saved to the R working directory), and a *Display* actor displays the text output by R.

C.4.1.2.2 Example Seven: Using Kepler Records

The workflow discussed in this section can be found under `KeplerData/workflows/module/r-2.X.Y/demos/R/RecordToDataframe-R.xml`

The workflow in *Figure C.22* uses an R-script to read and display a record originally specified by an *Expression* actor. In this case, the record represents a table. The *RExpression* actor will automatically create an R data frame from the record, provided that all the items in the record are arrays of the same length.

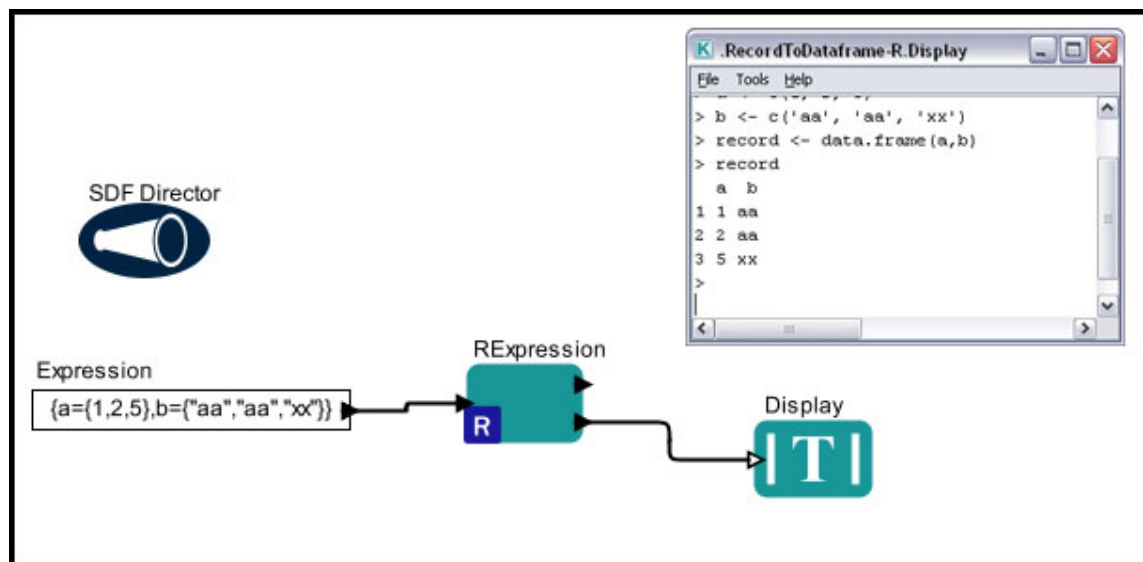

Figure C.22: Using a record specified by an *Expression* actor with the *RExpression* actor.

The *RExpression* actor in *Figure C.22* has a single user-defined input port (`record`), which receives the record data. The record specified by the *Expression* actor contains two named items, 'a' and 'b'. Each item is an array with three values, `{1,2,5}` and `{"aa","aa","xx"}`, respectively.

The *RExpression* actor uses an R-script to return the data frame object created by the actor. A *Display* actor displays the text output by R.

C.4.1.2.3 Example Eight: Using the *ReadTable* Actor with Local Text-Based Data Sets

The workflow discussed in this section can be found under `KeplerData/workflows/module/r-2.X.Y/demos/R/ReadTable.xml`

The workflow in *Figure C.23* uses a *ReadTable* actor to read a local, tab-delimited data set that has a 'spreadsheet-like' tabular format. The *ReadTable* actor creates an R data frame object from the data set and passes it to a second *RExpression* actor, which extracts the species and species-count information from the data set and creates a box plot of the data. The workflow uses an *Expression* actor (*Data File Name*) and two *Constant* actors (*Separator* and *header*) to pass arguments to the *ReadTable* actor: the name of the data set, the separator used by the data set, and a header, respectively.

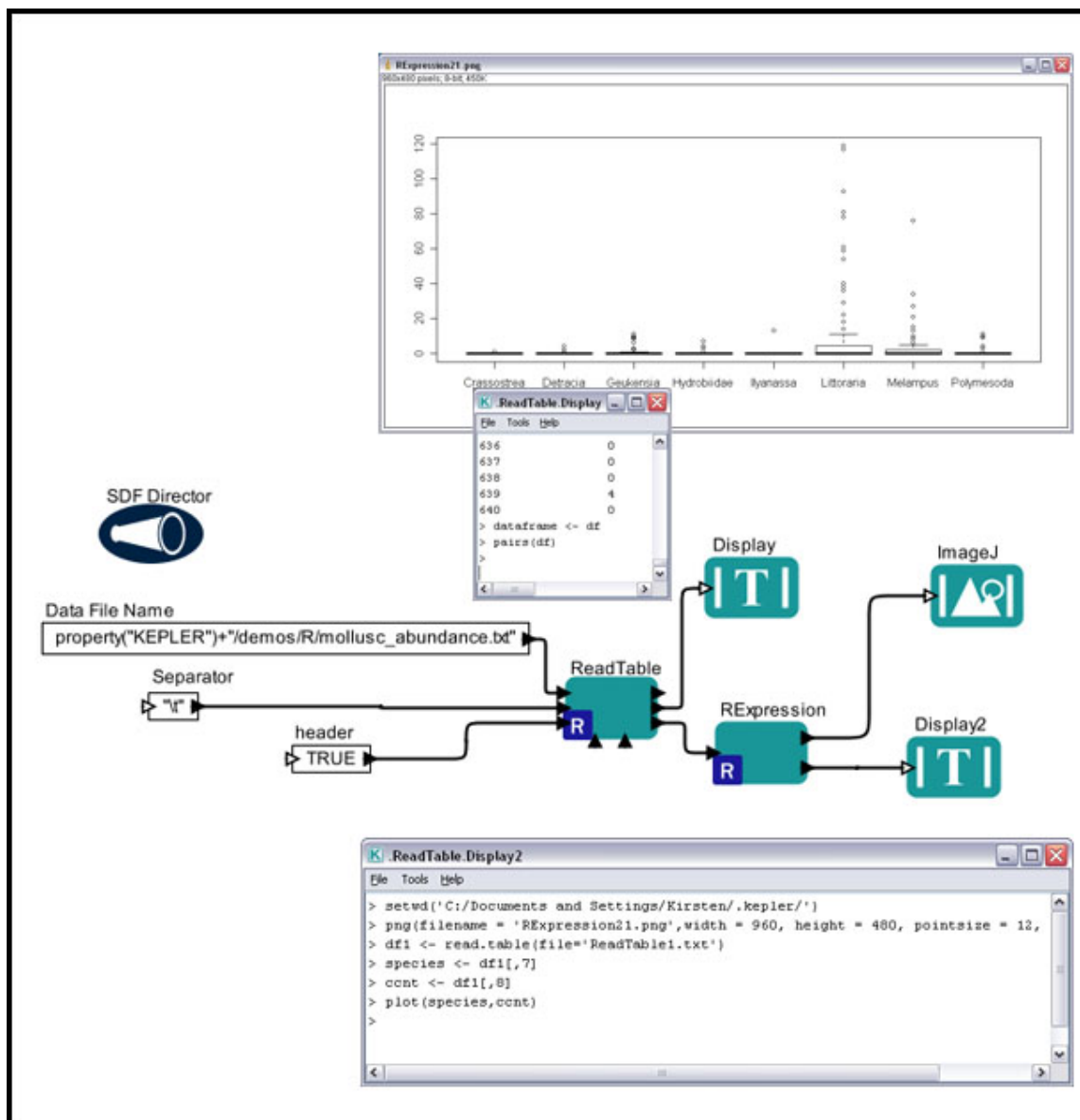

Figure C.23: Using the *ReadTable* actor to process a local tab-delimited data set.

The *ReadTable* actor has five input ports (`fileName`, `header`, `separator`, `nrows`, `fill`). The `fileName` port receives the location of the data set; the `separator` port accepts the delimiter (by default, any white space, such as a space or tab); the `header` is set to either `TRUE` (the default) or `FALSE` to indicate whether the first row of the data file contains column names; `nrows` is the number of records in the data table (by default, the *ReadTable* actor reads to the end of the file); and `fill` (set to either `TRUE` or `FALSE`) determines whether or not the actor should "fill" missing columns at the end of a line with empty strings. Often, all input ports other than the `fileName` can be left unconnected. See the R documentation for [read.table](#) for more information.

The default R-script in the *ReadTable* actor reads a data file and creates an R data frame object:

```
if (any(ls() == "header") == FALSE) header= TRUE
if (any(ls() == "separator") == FALSE) separator = ""
if (any(ls() == "nrows") == FALSE) nrows = -1
if (any(ls() == "fill") == FALSE) fill = TRUE
df <- read.table(fileName, sep=separator, header=header,
nrows=nrows, fill=fill)
df
dataframe <- df
pairs(df)
```

The *ReadTable* actor saves the data frame object to a text file in the R working directory and outputs the path to the file via the `dataframe` output port.

The *RExpression* actor in *Figure C.23* has a single user-defined input port (`df1`), which receives the R data frame. The actor's R-script creates a plot of the species and count data:

```
species <- df1[,7]
ccnt <- df1[,8]
plot(species, ccnt)
```

An *ImageJ* actor displays the plot and a *Display* actor displays the R-text output.

C.4.1.2.4 Example Nine: Passing DataFrames Between R-Actors

The workflow discussed below can be found under `KeplerData/workflows/module/r-2.X.Y/demos/R/RExpression_Dataframe_Test.xml`

The workflow in *Figure C.24* uses an *RExpression* actor to create a simple R data frame object and save it as a text file to the Kepler cache. The *RExpression* actor passes the location of the saved file to a second *RExpression* actor via a user-defined output port (`df`). The *RExpression2* actor reads the data file and selects the first row and column of data, which is output to a *Nonstrict Test* actor that compares the input against the value specified by its `correctValues` parameter. If the input matches the test criteria, the workflow produces no output. However, if the two do not match, Kepler will generate an error.

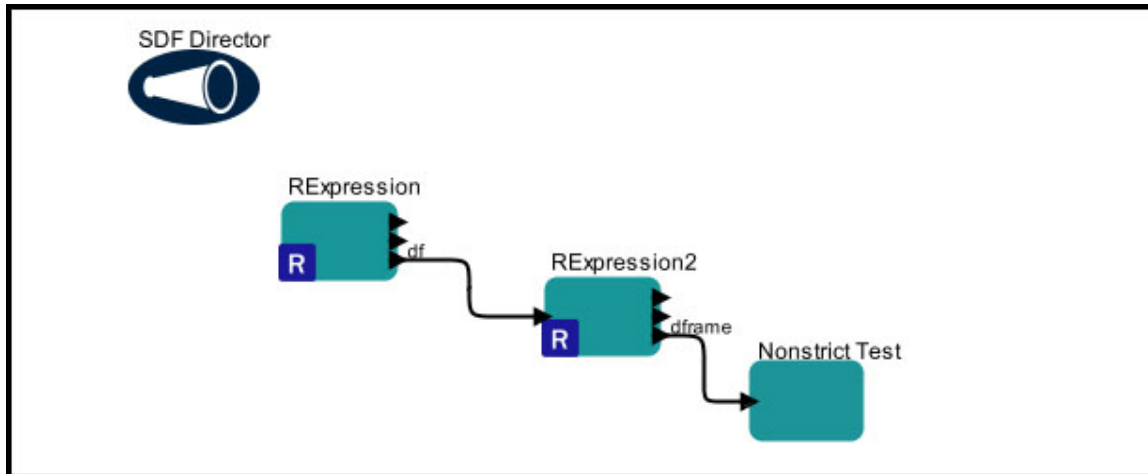

Figure C.24: Passing an R data frame object between *RExpression* actors.

The *RExpression* actor in Figure C.24 uses an R-script to create a simple data frame object that contains two vectors $\{1,2,3\}$ and $\{4,5,6\}$. The `c()` function used by the script builds the two vectors, which are then combined into a single data frame object with the `data.frame` function:

```
df <- data.frame(c(1,2,3),c(4,5,6))
```

The *RExpression* actor automatically saves the data frame object to the Kepler cache. A user-defined `df` port is used to pass the location of the data frame file to the *RExpression2* actor. Note that the output port should be named after the R-object it emits (e.g., the `df` port outputs the `df` object from the actor's R-script, in this case, the location of the data file). The `df` port must have type `string` (Figure C.25)

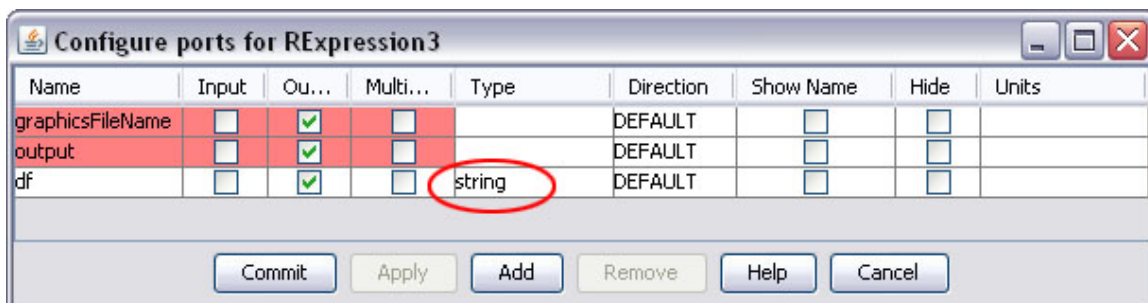

Figure C.25: Creating an output port (`df`) of type `string`.

The *RExpression2* actor receives the data frame via a user-defined input port named `df1`. Its R-script selects the first row and column of data:

```
df2 <- df1
dframe <- df2[1,1]
```

A user-defined output port (`dframe`) outputs the value of the first row and column of data (1.0). The *NonstrictTest* actor simply tests to ensure that the value is what is

expected. If the value does not match the value of the *NonstrictTest* actor's `correctValues` parameter, Kepler will generate an error message. If the values match, the workflow will execute without error or output.

Note: even though the array value was initially specified as an integer (1), it will be returned as a double (1.0) by the workflow. To force integer storage, use the syntax `1L` (or cast using `as.integer`).

C.4.2 Outputting Data

In the next sections, we will look at how to customize the *RExpression* actor to output results generated by the R-script (an array object in one case and a matrix object in another).

C.4.2.1 Outputting a Data Array

The workflow discussed below can be found under `KeplerData/workflows/module/r-2.X.Y/demos/R/R_output_example.xml`

The workflow in *Figure C.26* uses an R-script to create a pairs graph of several columns of EML-described meteorological data (barometric pressure, relative humidity, and air temperature). In addition, the workflow plots the relative humidity data and modified relative humidity data. All data are originally output as fields by an *EML2Dataset* actor (*Datos Meteorologicos*), which are combined into arrays an input to an *RExpression* actor. This data conversion is handled by three *SequenceToArray* actors. The *RExpression* actor reads the data arrays and combines them into a single R data frame. The *RExpression* actor outputs to *ImageJ*, *Display*, and *Array Plotter*.

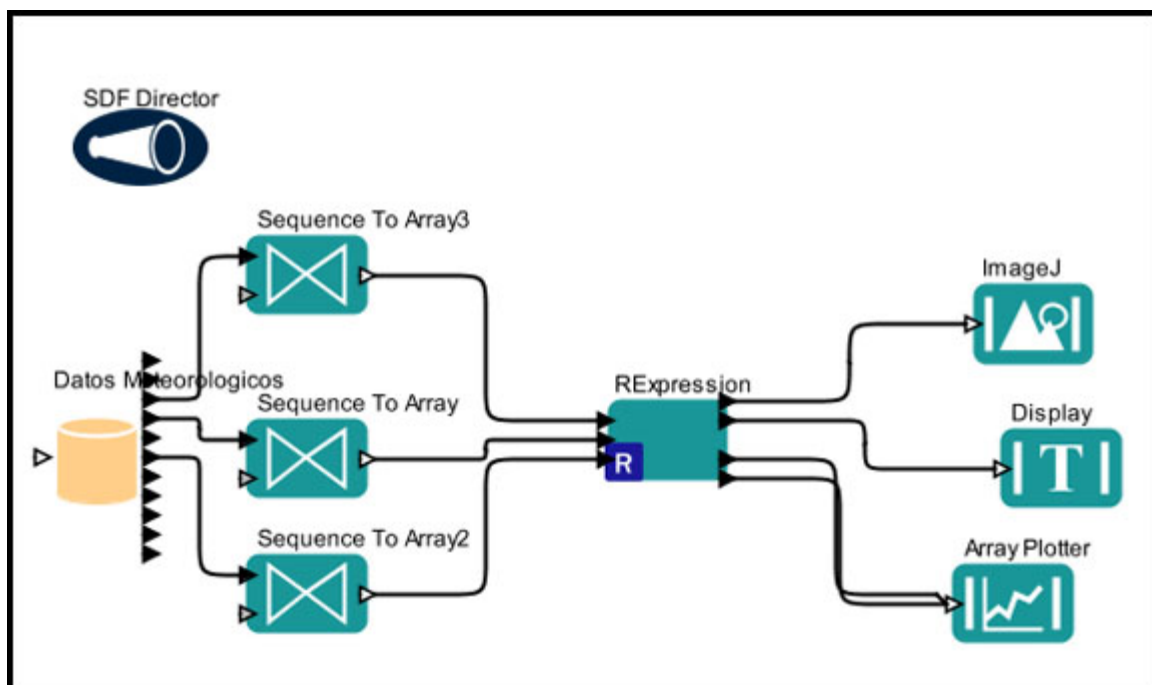

Figure C.26: User-defined output ports are used to output data from an *RExpression* actor.

The *RExpression* actor in *Figure C.26* reads three arrays of data (air temperature, relative humidity, and barometric pressure) via three user-defined input ports, T_AIR, RH, BARO, respectively. The R-script references the input data by the port names and, in addition to summarizing the data and creating a pairs graph, "renames" the RH vector XXX and creates a new vector of data (YYY) that contains doubled RH values.

```
df <- data.frame(T_AIR, RH, BARO)
summary(df)
pairs(df)
XXX <- RH
YYY <- 2*XXX
```

Two user-defined output ports (XXX and YYY) output the value of the RH data and the modified RH data, respectively. The output ports must be named after the R-objects they emit. Note that the RH vector had to be renamed in order to avoid duplicate port names. The *RExpression* actor (or any actor, for that matter) cannot have both an input and output port named RH.

An *ImageJ* actor displays the pairs graph (a .png file saved to the R working directory), a *Display* actor displays the text output by R, and the *ArrayPlotter* actor receives, plots, and displays the two RH arrays.

C.4.2.2 Outputting a Data Matrix

The workflow discussed below can be found under KeplerData/workflows/module/r-2.X.Y/demos/R/RExpression_Matrix_IO_Test.xml

The workflow in *Figure C.27* uses an R-script to create and output an R matrix. An *Expression* actor inputs a Kepler matrix into the *RExpression* actor, and a *NonstrictTest* actor is used to ensure that the matrix output is as expected.

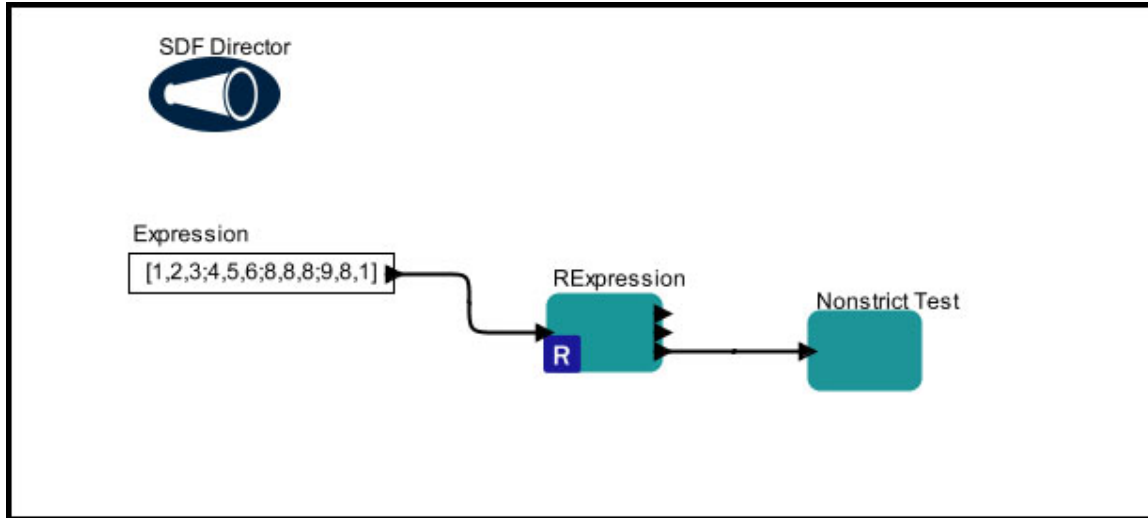

Figure C.27: Using the *RExpression* actor to output a matrix data object.

The *RExpression* actor in Figure C.27 reads a Kepler matrix specified by an *Expression* actor. The matrix is input to the *RExpression* actor via a user-defined port (`in1`). The R-script reads the value and creates an R matrix object:

```
in1
class(in1)
ma <- in1
```

A user-defined output port (`ma`) outputs the matrix data. The *NonstrictTest* actor simply tests to ensure that the value is what is expected. If the input value does not match the value of the *NonstrictTest* actor's `correctValues` parameter (Figure C.28), Kepler will generate an error message. If the values match, the workflow will execute without error or output.

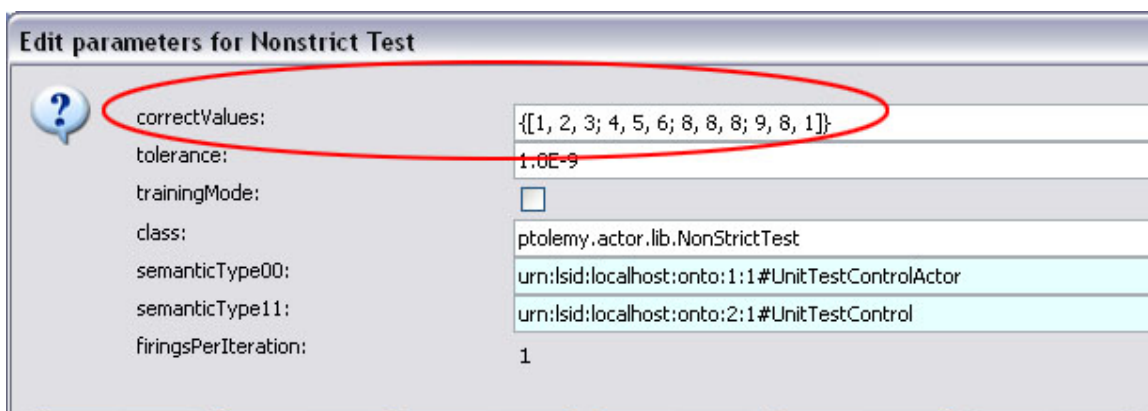

Figure C.28: The value of the `correctValues` parameter must match the *NonstrictTest* actor's input.

C.5 Example R Scripts and Functions

The following section contains examples of R workflows used for a variety of common statistical tasks, such as linear regression, plotting, statistical summaries, and sampling.

C.5.1 Simple Linear Regression

The workflow discussed below can be found under KeplerData/workflows/module/r-2.X.Y/demos/R/R/eml-simple-linearRegression-R.xml

The workflow in *Figure C.29* uses an *RExpression* actor (*R_linear_regression*) to perform and display a linear regression of two columns of data (air temperature and barometric pressure) from a meteorological dataset.

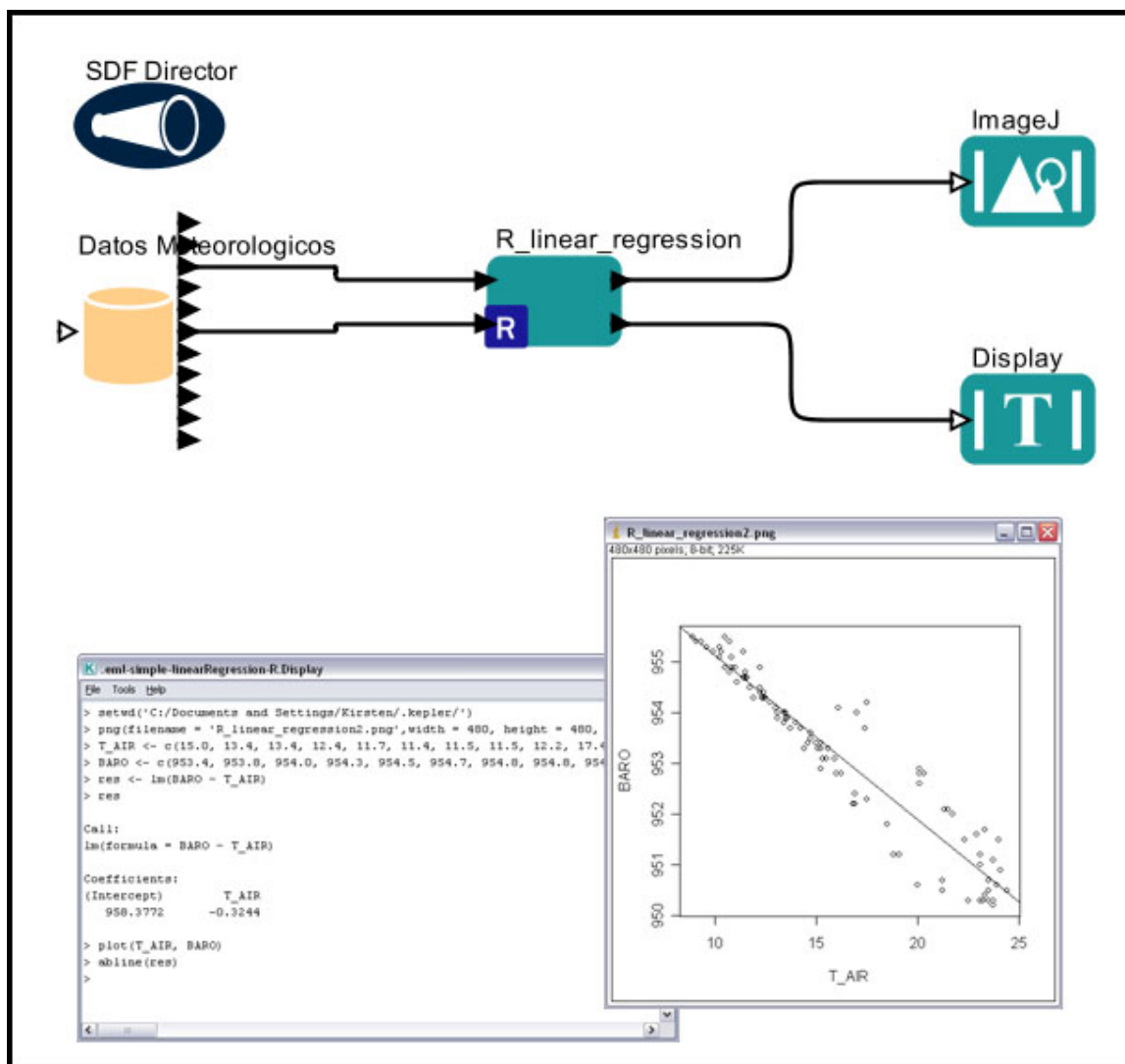

Figure C.29: Using the *RExpression* to perform a linear regression.

The *R_linear_regression* actor in *Figure C.29* reads two columns of meteorological data (air temperature and barometric pressure) via two user-defined input ports: `T_AIR` and `BARO`, respectively. The data are originally output `As Column Vectors` by the *EML2Dataset* actor (*Datos Meteorologicos*).

The *RExpression* actor converts the input data into R vectors, and then performs the linear regression. The script also adds a regression line through the scatter plot using the `abline()` function:

```
res <- lm(BARO ~ T_AIR)
res
plot(T_AIR, BARO)
abline(res)
```

An *ImageJ* actor displays the scatter plot (a `.png` file saved to the R working directory), and a *Display* actor displays the text output by R.

The *Regression* or the *LinearModel* actors—which are both preconfigured *RExpression* actors—can also be used to perform a linear regression. Please see Section C.5.7 for more information.

.

C.5.2 Basic Plotting

The workflow discussed below can be found under `KeplerData/workflows/module/r-2.X.Y/demos/R/eml-simple-plot-R.xml`

The workflow in *Figure C.30* uses an *RExpression* actor to plot two columns of data: relative humidity (y-axis) and barometric pressure (x-axis) from a meteorological dataset.

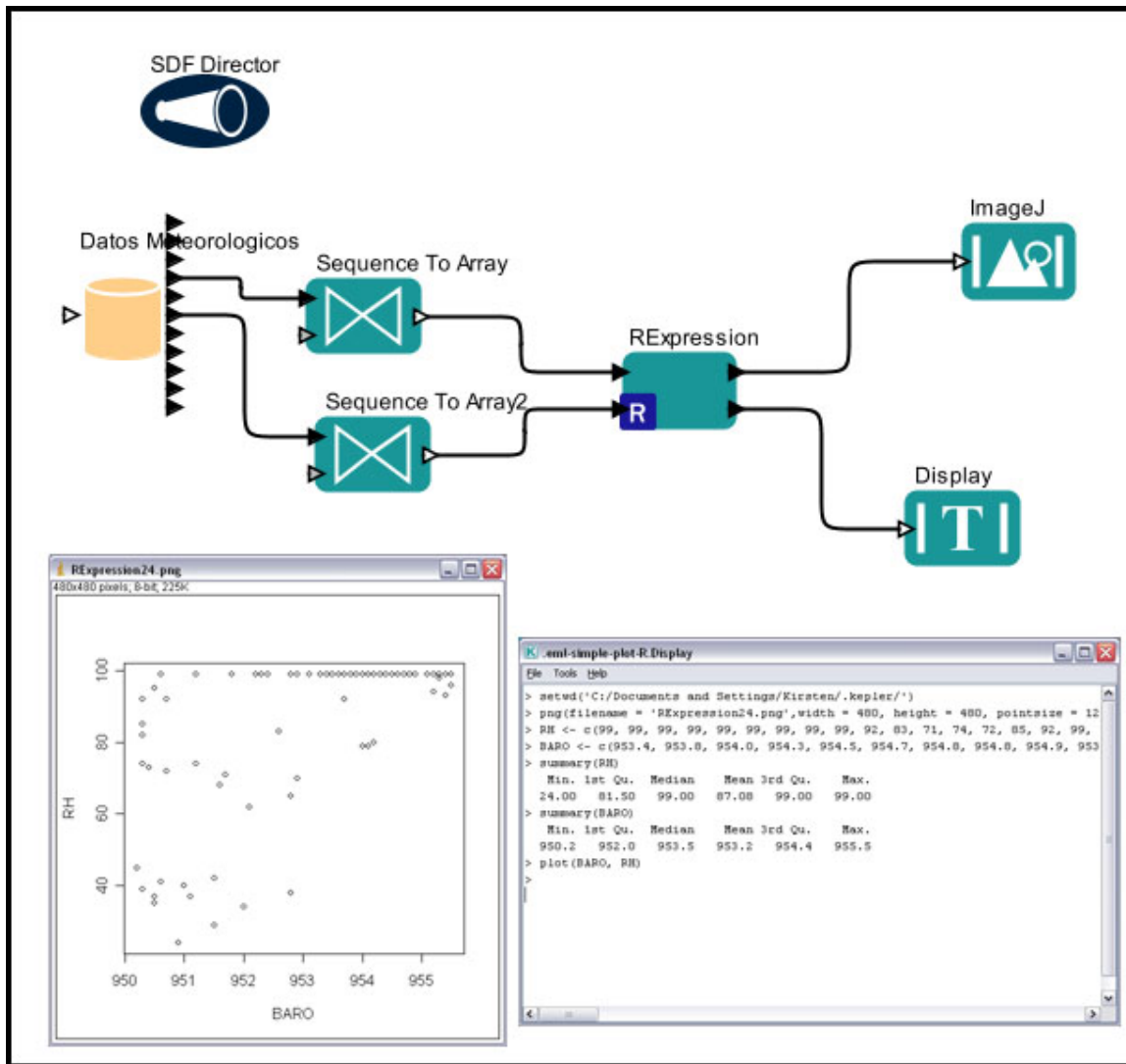

Figure C.30: Using the *RExpression* to plot data.

The *RExpression* actor in Figure C.30 reads two columns of meteorological data (relative humidity and barometric pressure) via two user-defined input ports: RH and BARO, respectively. The data are originally output as fields by the *EML2Dataset* actor (*Datos Meteorologicos*). The fields are joined into arrays by two *SequenceToArray* actors. For more information about using *SequenceToArray* actors in this way, please see Section C.4.1.1.4.

The R-script summarizes the two data sets and creates a plot of the values:

```
summary(RH)
summary(BARO)
plot(BARO, RH)
```

An *ImageJ* actor displays the scatter plot (a .png file saved to the R working directory), and a *Display* actor displays the text output by R.

The *RPlot*, *Scatterplot*, *Boxplot* and *Barplot* actors—which are preconfigured *RExpression* actors—can also be used to generate plots. Please see Section C.5.7 for more information.

C.5.3 Summary Statistics

The workflow discussed below can be found at `KeplerData/workflows/module/r-2.X.Y/demos/R/eml-summary-stats-R.xml`

The workflow in *Figure C.31* uses an *RExpression* actor to generate summary statistics (mean, standard deviation, and variance) for a single column of data (barometric pressure) from a meteorological dataset.

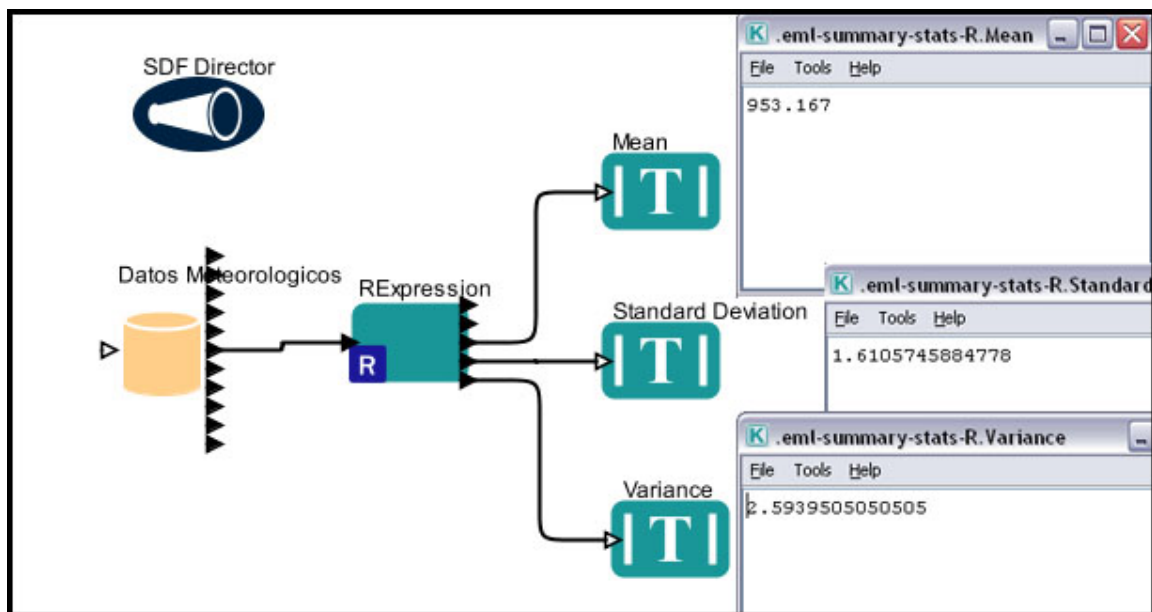

Figure C.31: Using the *RExpression* to generate summary statistics.

The *RExpression* actor in *Figure C.31* reads barometric pressure data via a user-defined input port (`x`). The data are originally output as a column vector by the *EML2Dataset* actor (*Datos Meteorologicos*). The R-script creates the summary statistics:

```
xmean = mean(x)
xstd = sd(x)
xvar = var(x)
```

Three user-defined output ports (`xmean`, `xstd`, and `xvar`) output the generated statistics. The output ports must be named after the R-objects they emit. *Display* actors display the output statistics.

The *Summary*, *SummaryStatistics*, *RMean*, and *RMedian* actors can also be used to generate summary statistics. Please see Section C.5.7 for more information.

C.5.4 3D Plotting

The workflow discussed below can be found at KeplerData/workflows/module/r-2.X.Y/demos/R/R_3D_Plot.xml

The workflow in *Figure C.32* uses an *RExpression* actor to generate a 3D plot (a rotated sine function).

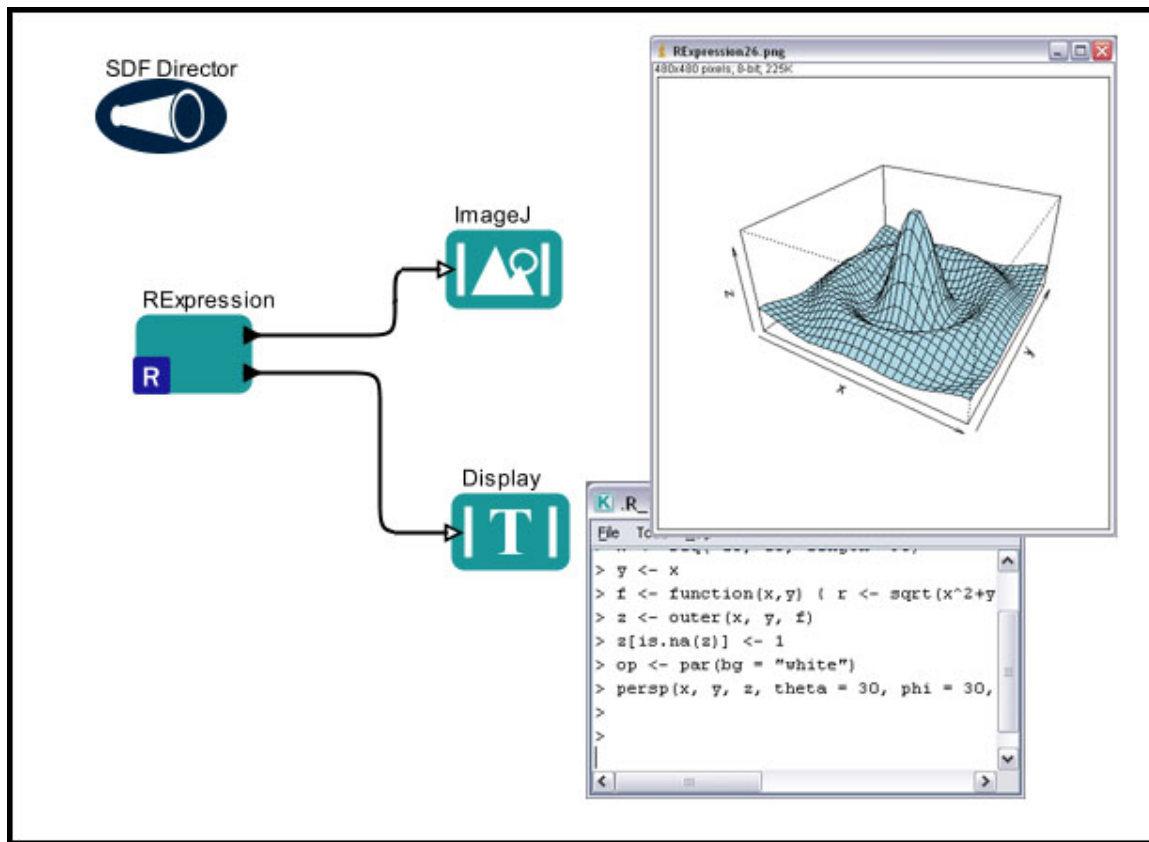

Figure C.32: Using the *RExpression* to generate a 3D plot.

The *RExpression* actor in *Figure C.32* generates a 3D plot using the following R-script:

```
x <- seq(-10, 10, length= 30)
y <- x
f <- function(x,y) { r <- sqrt(x^2+y^2); 10 * sin(r)/r }
z <- outer(x, y, f)
z[is.na(z)] <- 1
op <- par(bg = "white")
persp(x, y, z, theta = 30, phi = 30, expand = 0.5, col =
"lightblue")
```

An *ImageJ* actor displays the 3D plot (a .png file saved to the R working directory), and a *Display* actor displays the text output by R.

C.5.5 Biodiversity and Ecological Analysis and Modeling (BEAM)

The workflow discussed below can be found under KeplerData/workflows/module/r-2.X.Y/demos/R/BEAM_4_1.xml

The workflow in *Figure C.33* uses four *RExpression* actors to generate the relationship between area sampled and species richness (a rarefaction curve) for a data set, and then finds the best-fit linear model for predicting this relationship. These actors (1) convert a local data set containing plant biomass data into a site by species matrix, (2) generate a species richness/area relationship using a bootstrap method, (3) find the best-fit linear model for the relationship, and (4) create a plot of the results.

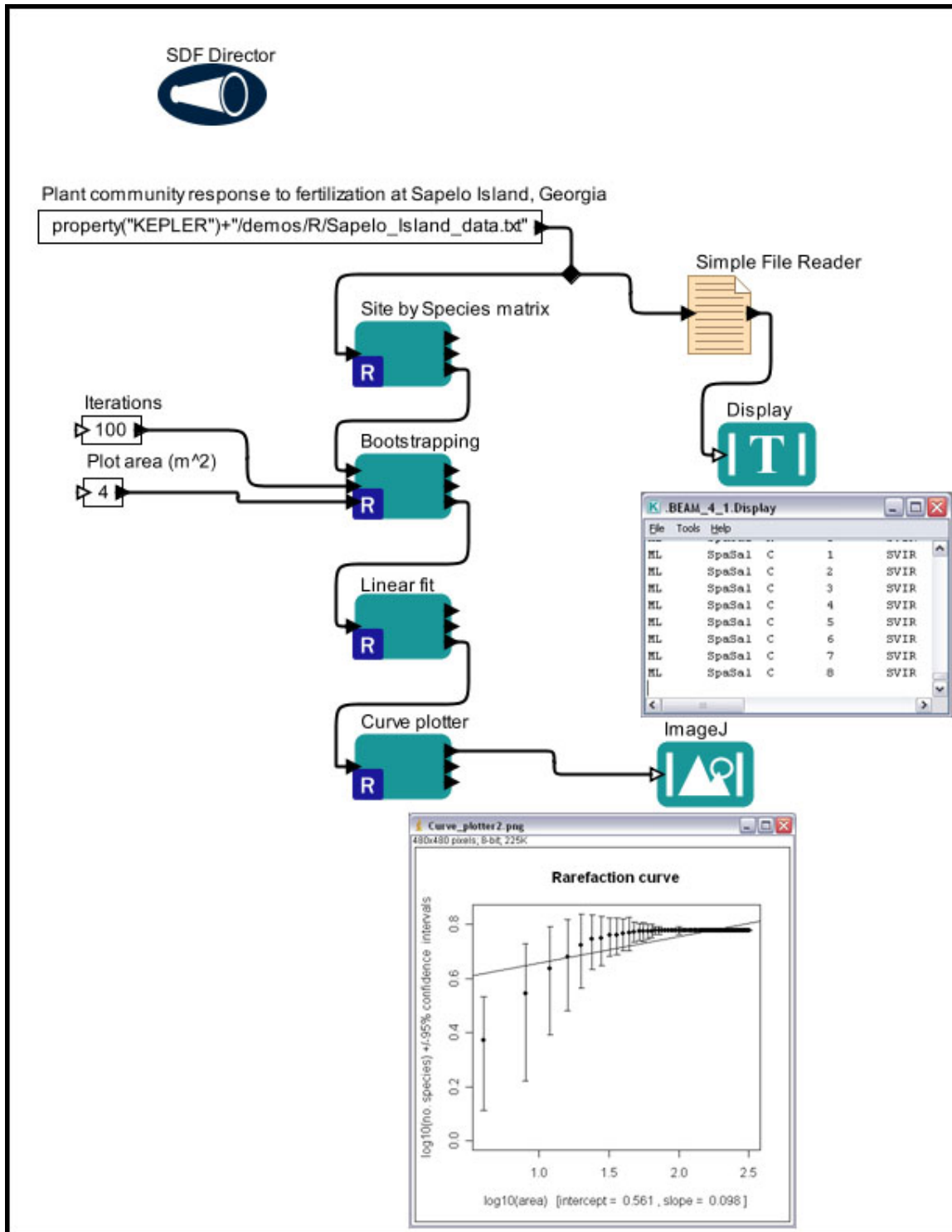

Figure C.33: The Biodiversity and Ecological Analysis and Modeling (BEAM) workflow.

The data used in the workflow (Sapelo_island_data.txt) is a text file that contains information about parallel fertilization experiments that were performed at three different geographical sites containing five different types of perennial plant communities found in

the salt marsh habitat around Sapelo Island, Georgia. Sixteen one-meter square plots were placed within each plant community, and alternate plots were assigned to control and fertilization treatments. The central 0.5m x 0.5m of each plot was harvested and live plants were sorted to species, dried to a constant mass, and weighed to measure biomass. The species biomass for the entire one meter plot was estimated from the sample. The original data table contains nine columns of data: site code, plant community code, fertilization treatment (N for fertilized sites, C for control), treatment replicate (1-8), plant species code, taxonomic serial number, plant mass per .25 square meter quadrant, and plant mass calculated per square meter.

The workflow's first *RExpression* actor, *Site by Species matrix*, reads the data file and "reorganizes it", dropping fields that are not relevant to the current calculation (e.g., the taxonomic serial number as well as the estimate of plant mass per square meter), and creating a table of the presence (1) or absence (0) of species at each combination of Site, Community, Treatment, and Replicate. The new data object is written to a text file (*Site_by_Species.txt*) that is stored in the R working directory (the Kepler cache, by default). The R actor is set to save the R workspace so that other downstream actors can access the data (*Figure C.34*).

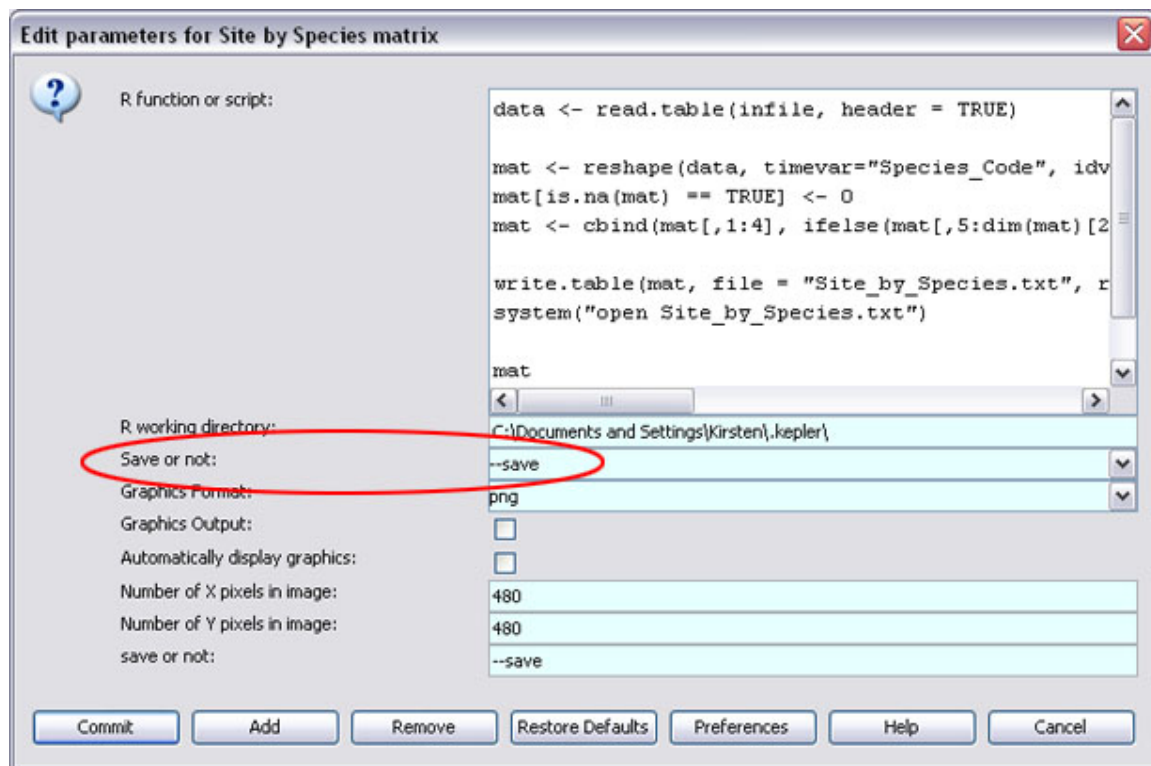

Figure C.34: Save the R workspace by setting the *Save or not* parameter to `--save`.

The *Bootstrapping* actor loads the species data and uses a randomization to estimate the expected number of species present in increasingly larger sample plot areas. The actor randomly selects experimental plots until a given area is reached (from 4 to 320 square meters, in the example), and then sums the number of species present in that area. By repeating this process a number of times (in this case 100), a distribution expected

species richness is estimated, and the mean and 95% confidence intervals are calculated (y-axis) for given sample areas (x-axis). The actor creates a summary table containing mean species richness and 95% confidence intervals for each area sampled. The number of iterations to perform for each estimate, as well as the initial plot area, are specified via *Constant* actors.

The *LinearFit* actor loads the R data and fits a linear model (or regression) to the mean species richness estimates as a function of sampled area (both axes have been log-transformed). In this case, the linear model does not fit the rarefaction curve well, and other models should be investigated. The *Curve plotter* actor creates a plot of both the rarefaction curve and the linear model, and the *ImageJ* actor displays this plot in Kepler.

C.5.6 Random Sampling

The workflow discussed below can be found under KeplerData/workflows/module/r-2.X.Y/demos/R/sampling_occurrenceData_R.xml

The workflow in *Figure C.35* uses an *RExpression* actor to read a local text file containing a data set of latitude/longitude species occurrence locations, and divide the data into two randomly assigned subsets.

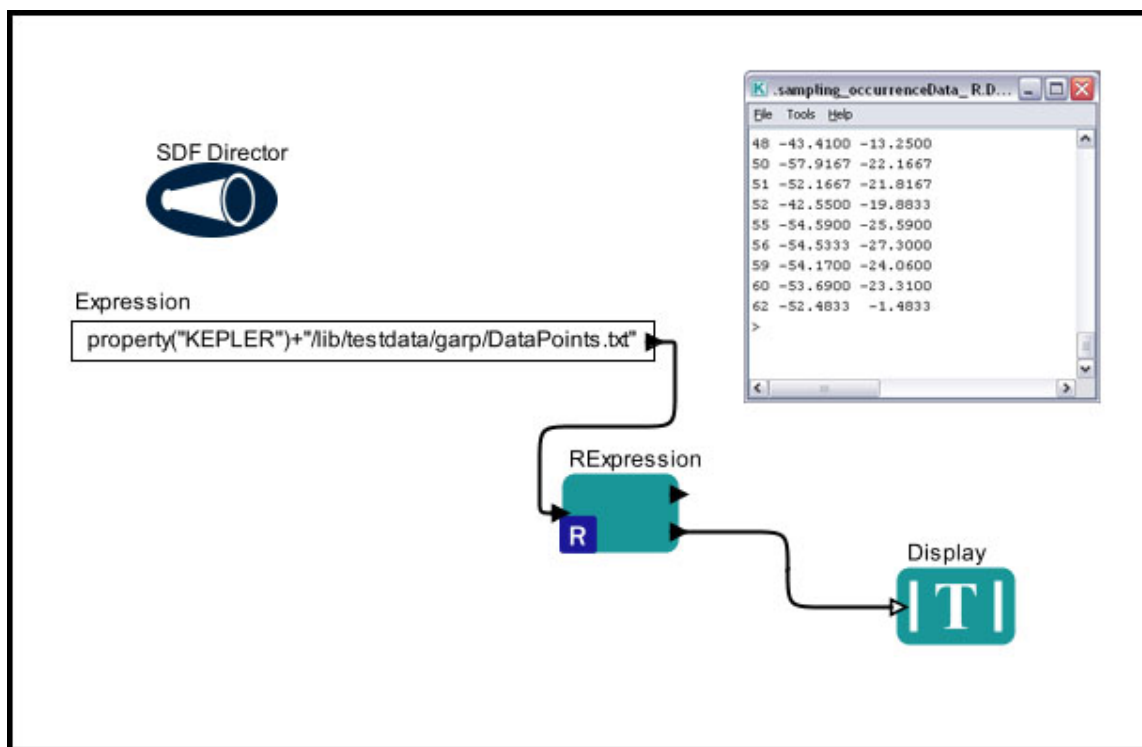

Figure C.35: Using the *RExpression* actor to split a data set.

The location of the data set is specified by an *Expression* actor. The data are input to the *RExpression* actor via a user-defined `fileName` port. The *RExpression* actor uses the following R-script to create an R data-frame from the data and randomly assign each value to one of two subsets:

```

# read the original data
df <- read.table(fileName)
# get number of rows (i.e. number of lines)
l11 <- length(df$V1)
fraction <- 0.5
# create a list of subset indices
sss <- sample(1:l11, size=(fraction*l11))
# create 2 subsets
df1 <- df[sss,]
# write output file
#sink("FirstSubset.txt")
#df1
#sink()
df2 <- df[-(sss),]
# write output file
#sink("SecondSubset.txt")
#df2
#sink()

df1
df2

```

Note that comments can be added to R-scripts using the `#` syntax. A *Display* actor displays the text output by R.

C.5.7 Custom RExpression Actors

The Kepler library contains a number of useful R actors that are "preconfigured" with R-scripts and ports: *Barplot*, *Box plot*, *Correlation*, *LinearModel*, *RandomNormal*, *RandomUniform*, *ReadTable*, *Regression*, *RMean*, *RMedian*, *RQuantile*, *Scatterplot*, *Summary*, *SummaryStatistics*.

Many custom *RExpression* actors are intended to be reused in multiple workflows and therefore use "generic" port names that will not necessarily correspond to the data. The *Scatterplot* actor is a prime example. It has two input ports: `Independent` and `Dependent` that are used to plot the graph.

C.5.7.1 Barplot

The *Barplot* actor creates and saves a barplot graph. The actor outputs the path to the saved barplot, which can be displayed by the *ImageJ* actor (*Figure C.36*).

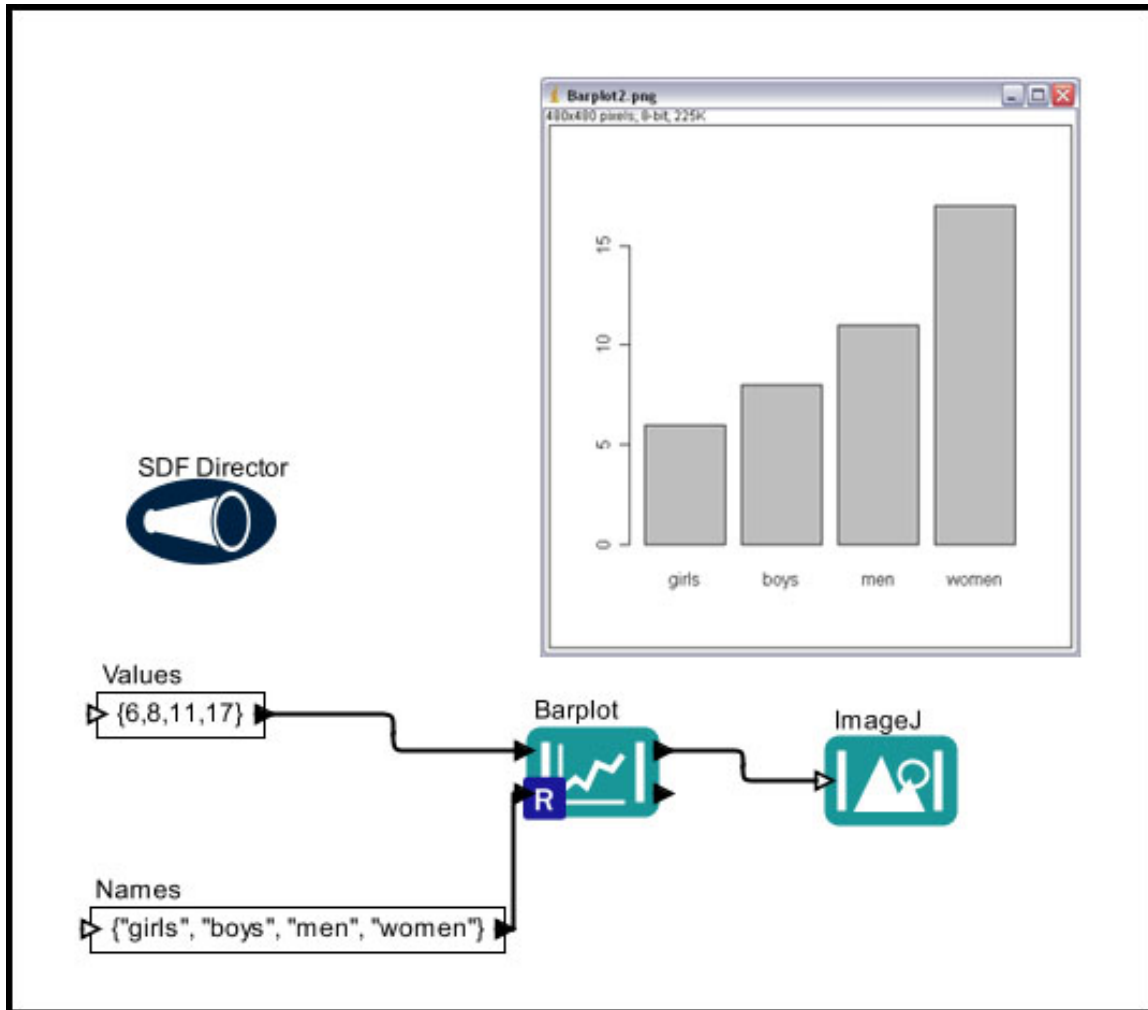

Figure C.36: Using the *Barplot* actor.

C.5.7.2 Boxplot

The *Boxplot* actor creates and saves a boxplot that is based on a data set's "five-number summaries"--the smallest observation, lower quartile (Q1), median, upper quartile (Q3), and largest observation. The actor reads an array of values to plot and, optionally, an array over which the values are divided (an array of dates, for example). The actor outputs the path to the saved boxplot, which can be displayed by the *ImageJ* actor (Figure C.37).

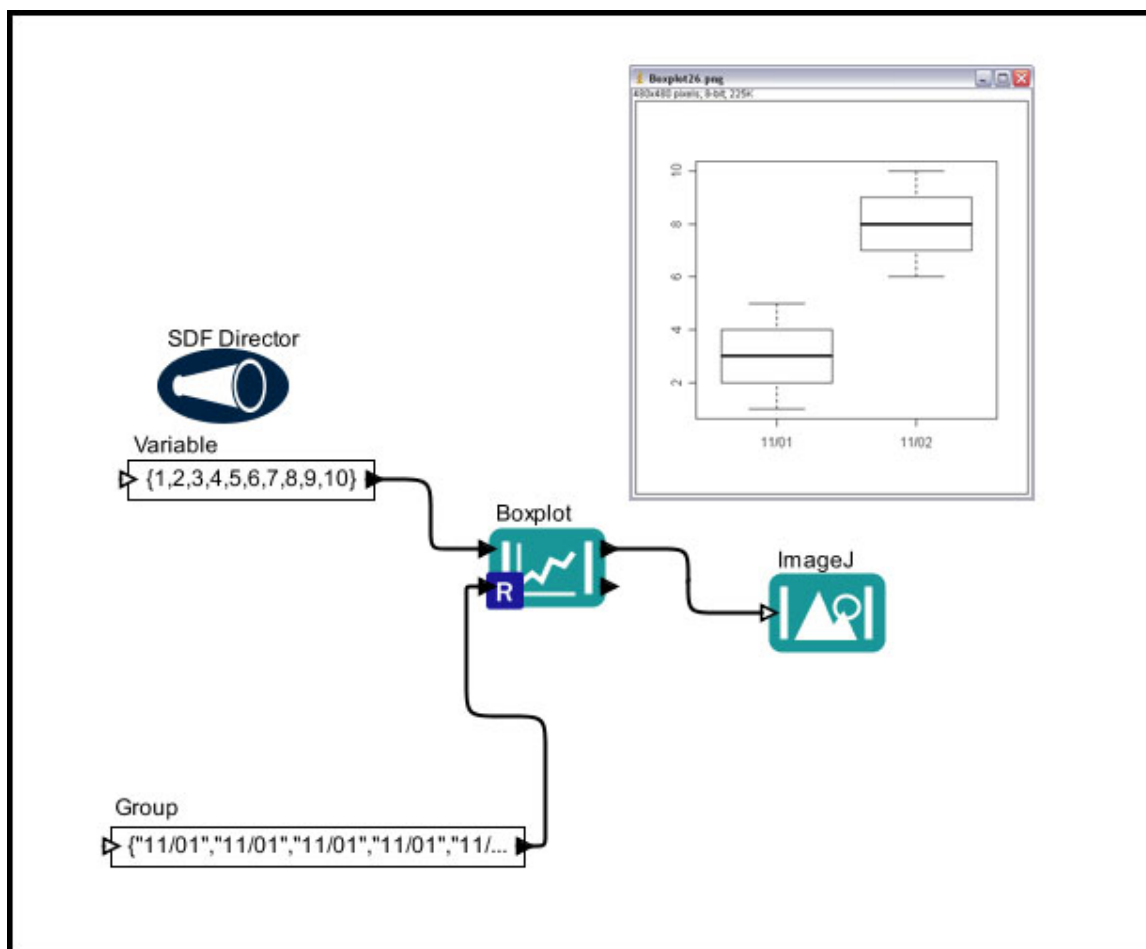

Figure C.37: Using the *Boxplot* actor. The sample data points fall into one of two groups: 11/01 or 11/02.

C.5.7.3 Correlation

The *Correlation* actor performs tests of association between two input variables: `Variable1` and `Variable2`, which contain data arrays of equal length. The actor outputs the level of association (r , ρ , or τ , depending on the analysis) between the two variables, an estimate of the p-value (if possible), and n (the number of items in the array) (*Figure C.38*). By default, the actor performs a Pearson's correlation analysis; to specify another analysis type, connect a *Constant* actor to the actor's `method` port and enter the type of analysis (e.g., "spearmen" or "kendall").

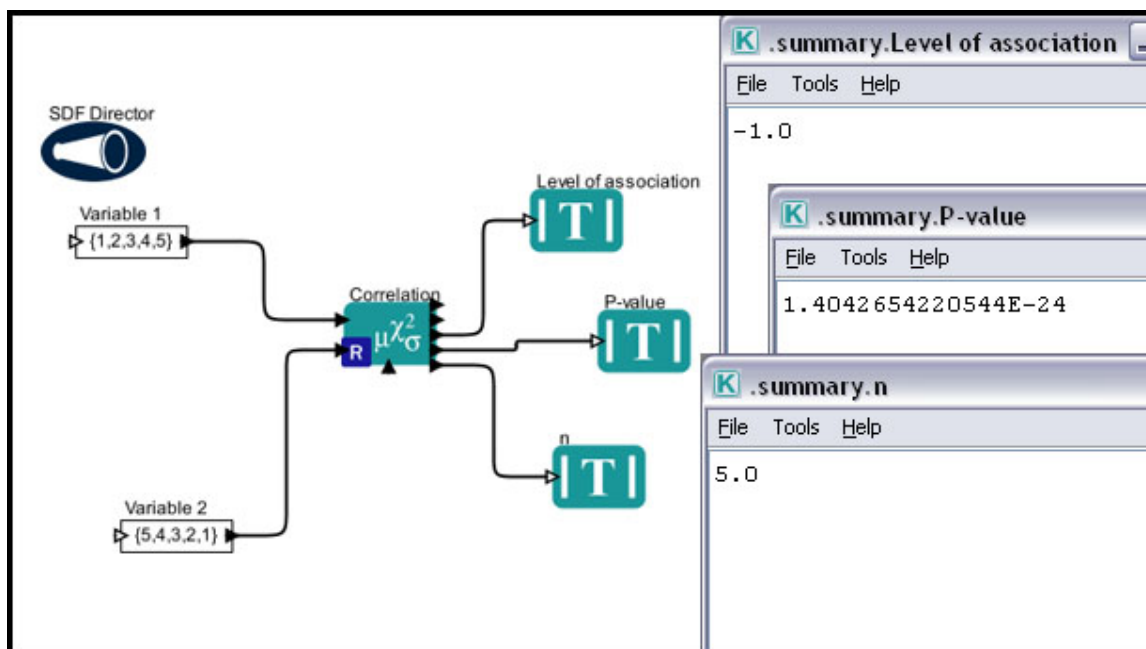

Figure C.38: Using the *Correlation* actor.

C.5.7.4 LinearModel

The *LinearModel* actor runs a variance or linear regression analysis on its inputs and outputs the result (Figure C.39).

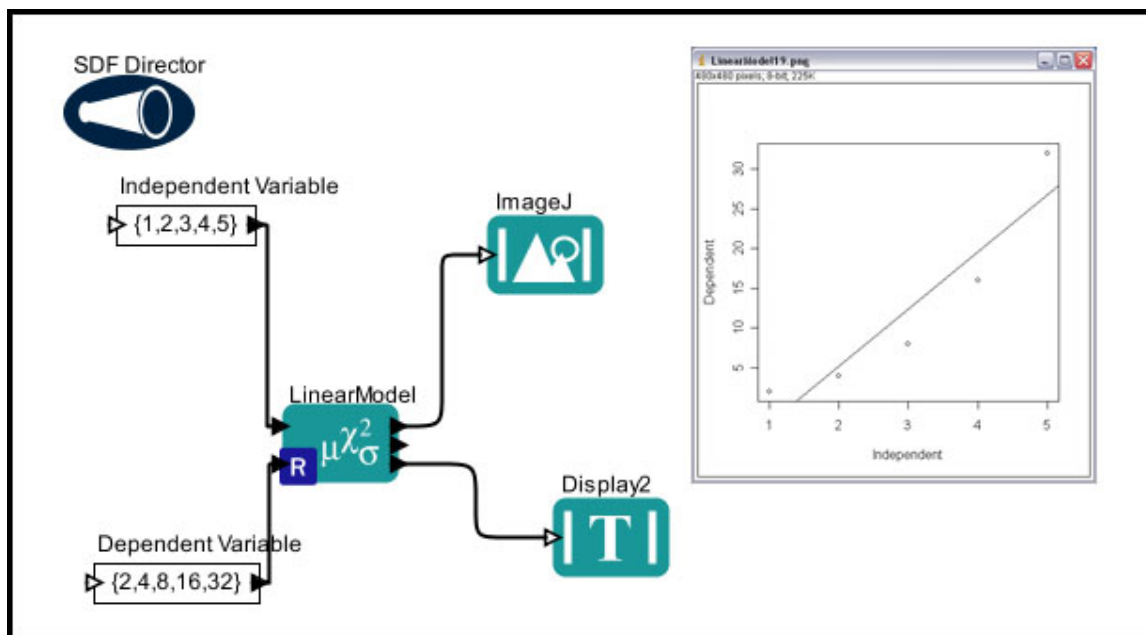

Figure C.39: Using the *LinearModel* actor.

The *LinearModel* actor accepts an independent and a dependent variable, which are specified as arrays (If using an EML data set, select "As Column Vector" as the output format). If the independent variable is categorical, the actor runs a variance analysis (or a t-test if the variable has only 2 categories). If the independent variable is continuous, a linear regression is run. The actor outputs both a graphical and textual representation of the analysis.

C.5.7.5 RandomNormal

The *RandomNormal* actor generates and outputs a set of normally (Gaussian) distributed numbers with a mean of 0 and a standard deviation of 1 (*Figure C.40*). Specify the number of random numbers to generate with a *Constant* actor. The actor outputs an array of the random numbers as well as the file path to a histogram of the distribution, which can be displayed with an *ImageJ* actor.

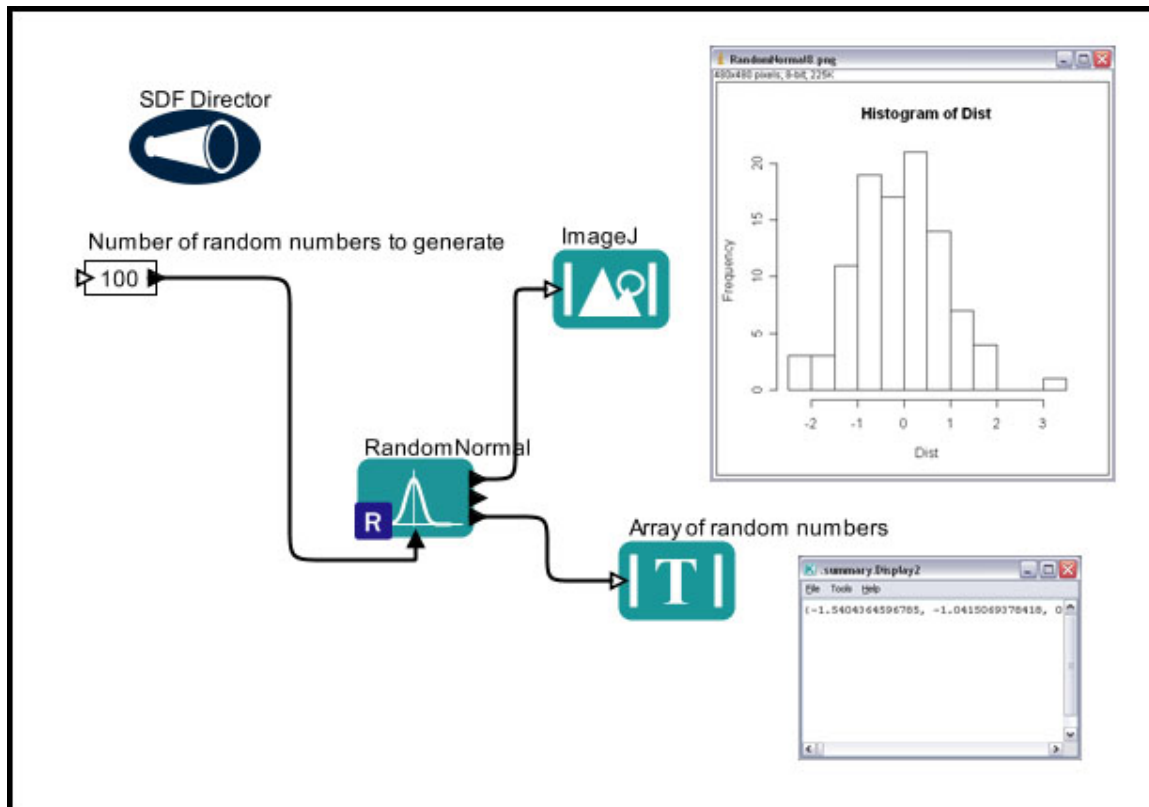

Figure C.40: Using the *RandomNormal* actor.

C.5.7.6 RandomUniform

The *RandomUniform* actor generates and outputs a set of uniformly distributed numbers. Specify the number of random numbers to generate with a *Constant* actor (*Figure C.41*). The actor outputs an array of random numbers as well as the path to a histogram of the distribution, which can be displayed with an *ImageJ* actor.

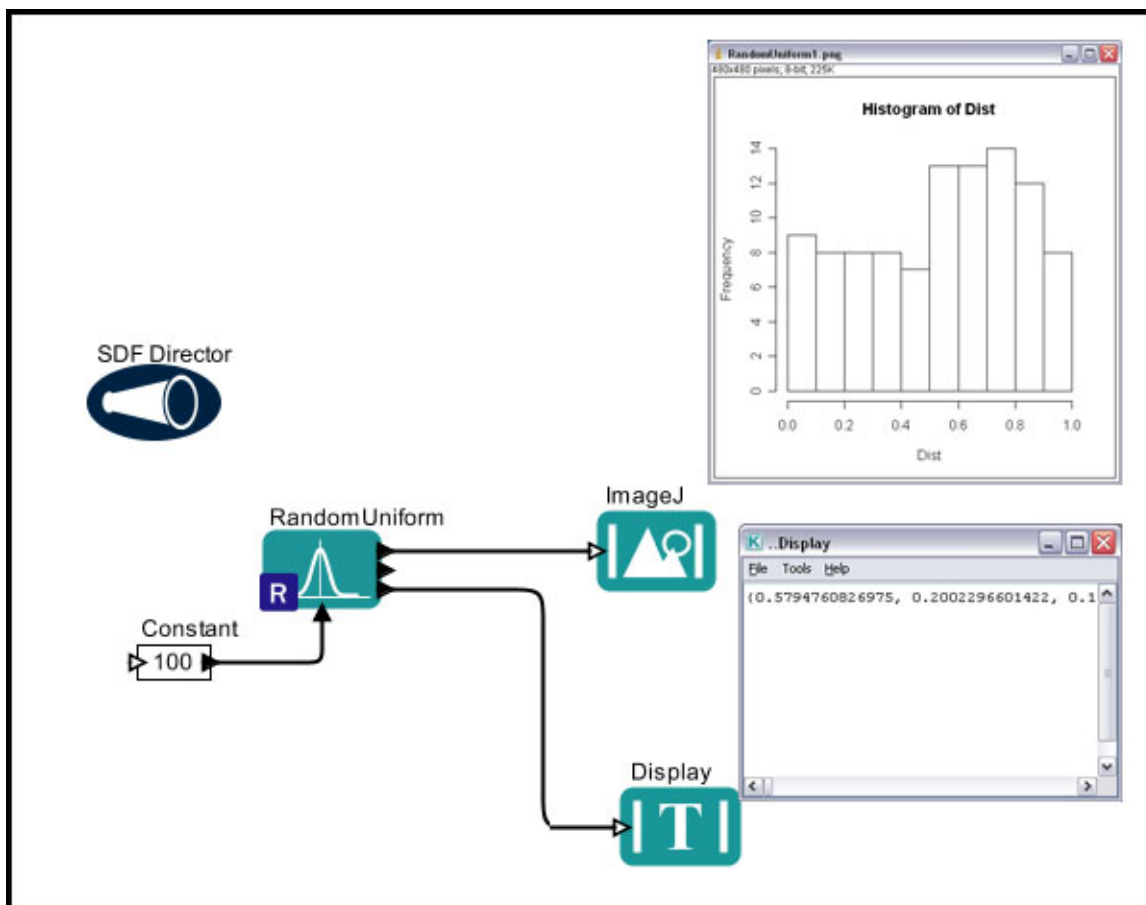

Figure C.41: Using the *RandomUniform* actor.

C.5.7.7 ReadTable

The *ReadTable* actor reads a local, text-based, delimited data file and outputs the data in a format that can be used by other R actors. For an example of this actor, please see Section C.4.1.2.4.

C.5.7.8 Regression

The *Regression* actor runs a variance or linear regression analysis (Figure C.42). The actor accepts an independent and a dependent variable, which are specified as arrays. If using an EML data set, select "As Column Vector" as the output format. If the independent variable is categorical, the actor uses R to run a variance analysis (or a t-test if the variable has only 2 categories). If the independent variable is continuous, a linear regression is run. The actor outputs both a graphical and textual representation of the analysis.

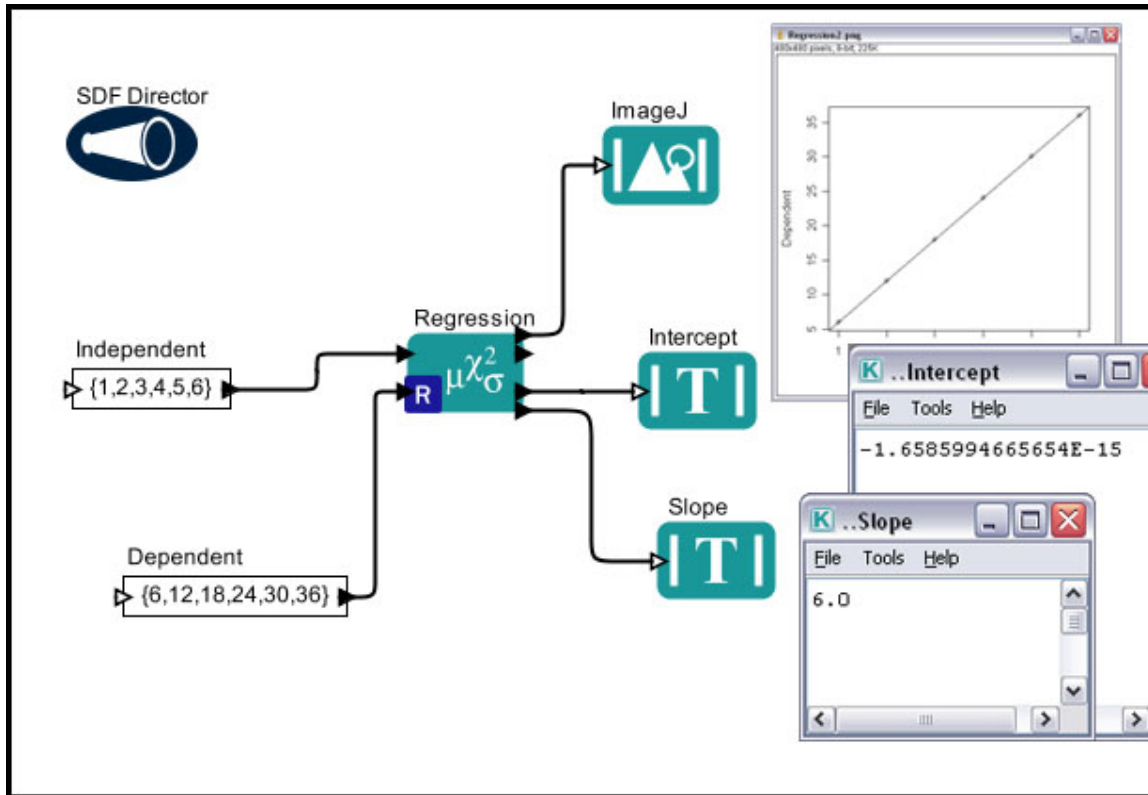

Figure C.42: Using the *Regression* actor.

C.5.7.9 RMean

The *RMean* actor accepts an array of values and calculates their mean. If using an EML data set, select "As Column Vector" as the output format. The actor outputs a histogram of the data as well as the mean (Figure C.43).

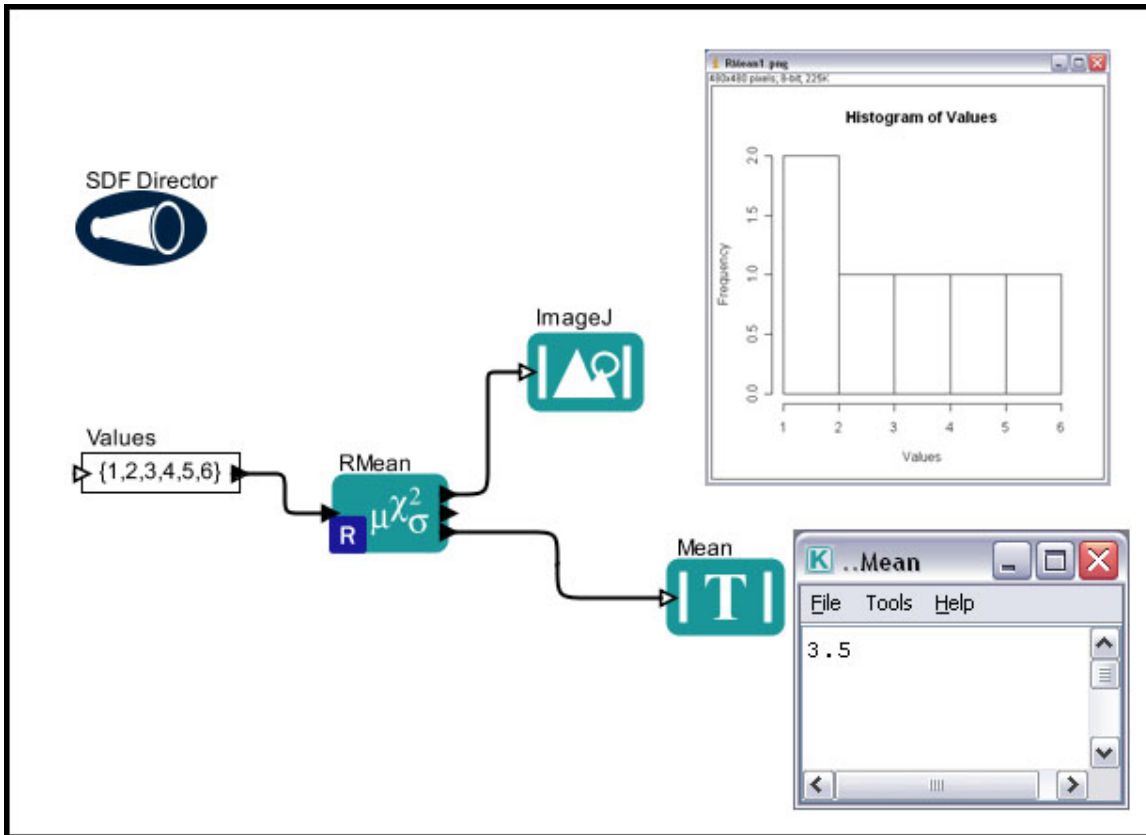

Figure C.43: Using the *RMean* actor.

C.5.7.10 RMedian

The *RMedian* actor accepts an array of values and calculates their median (Figure C.44).

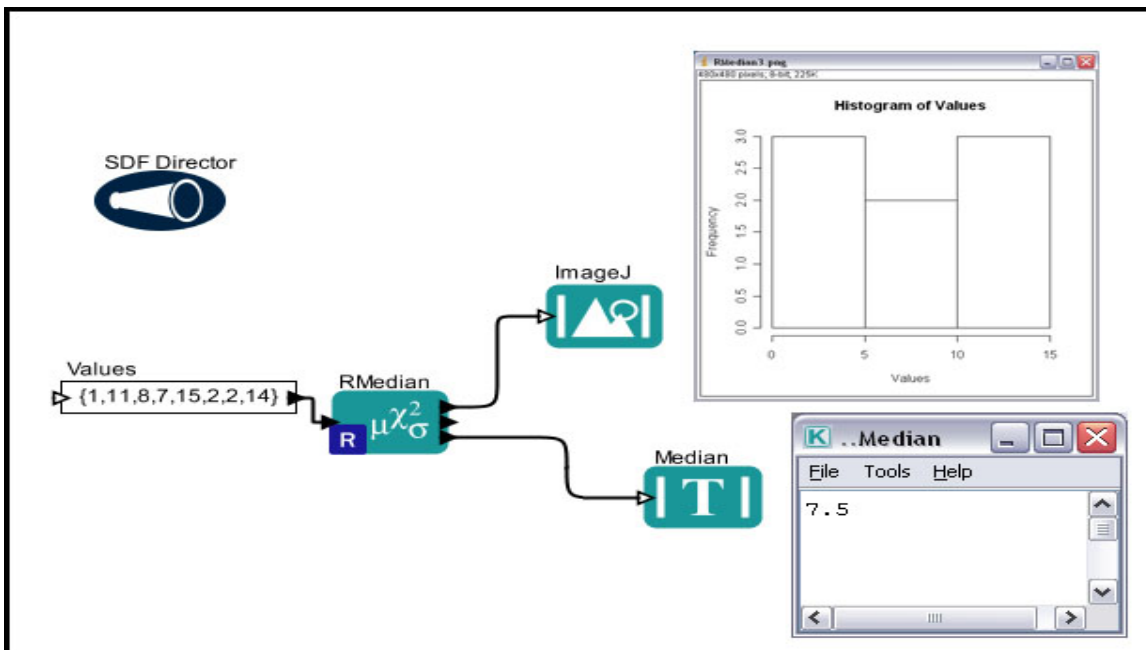

Figure C.44: Using the *RMedian* actor.

If using an EML data set, select "As Column Vector" as the output format. The actor outputs a histogram of the values as well as the median value

C.5.7.11 RQuantile

The *RQuantile* actor accepts an array of data and generates sample quantiles. If using an EML data set, select "As Column Vector" as the output format. The actor outputs a histogram of the data as well as the generated quantiles (*Figure C.45*). One or more P-values, specified with a *Constant* actor, specify which quantiles to calculate and return. P-values must fall between 0 and 1.

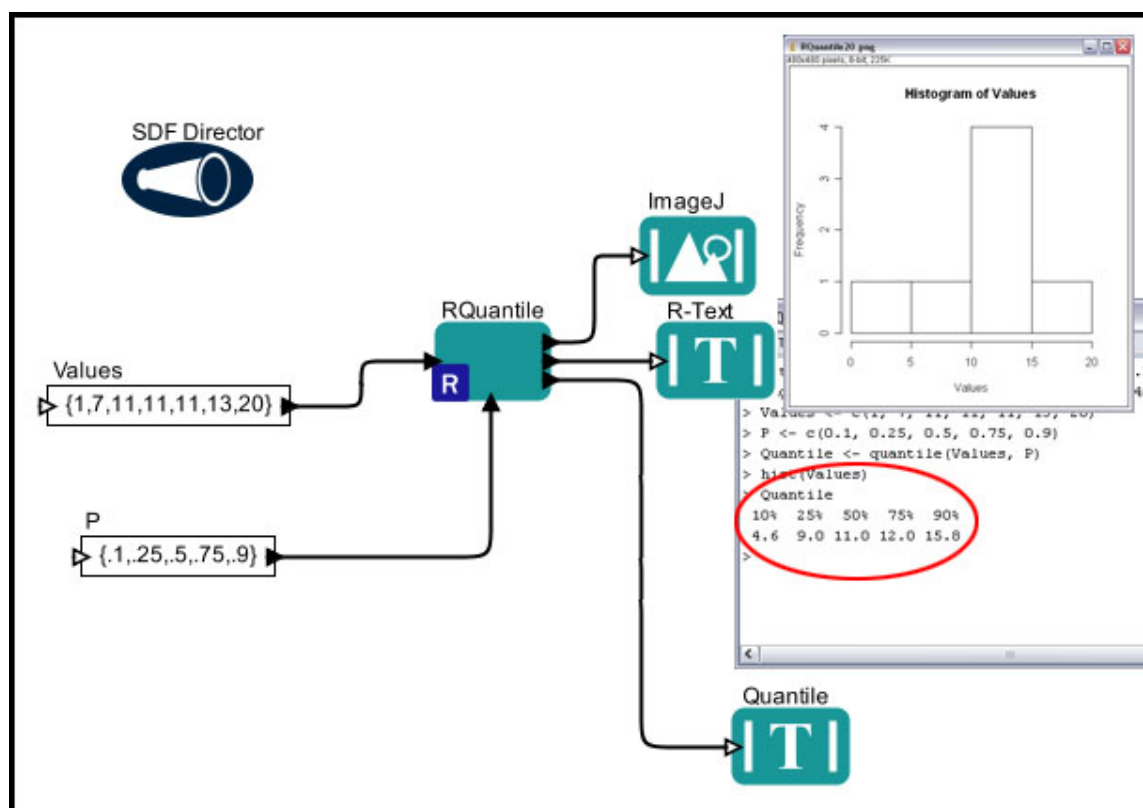

Figure C.45: Using the *RQuantile* actor.

C.5.7.12 Scatterplot

The *Scatterplot* actor reads an independent and a dependent variable, which are specified as arrays. If using an EML data set, select "As Column Vector" as the data output format. The actor creates and saves a scatter plot. (*Figure C.46*).

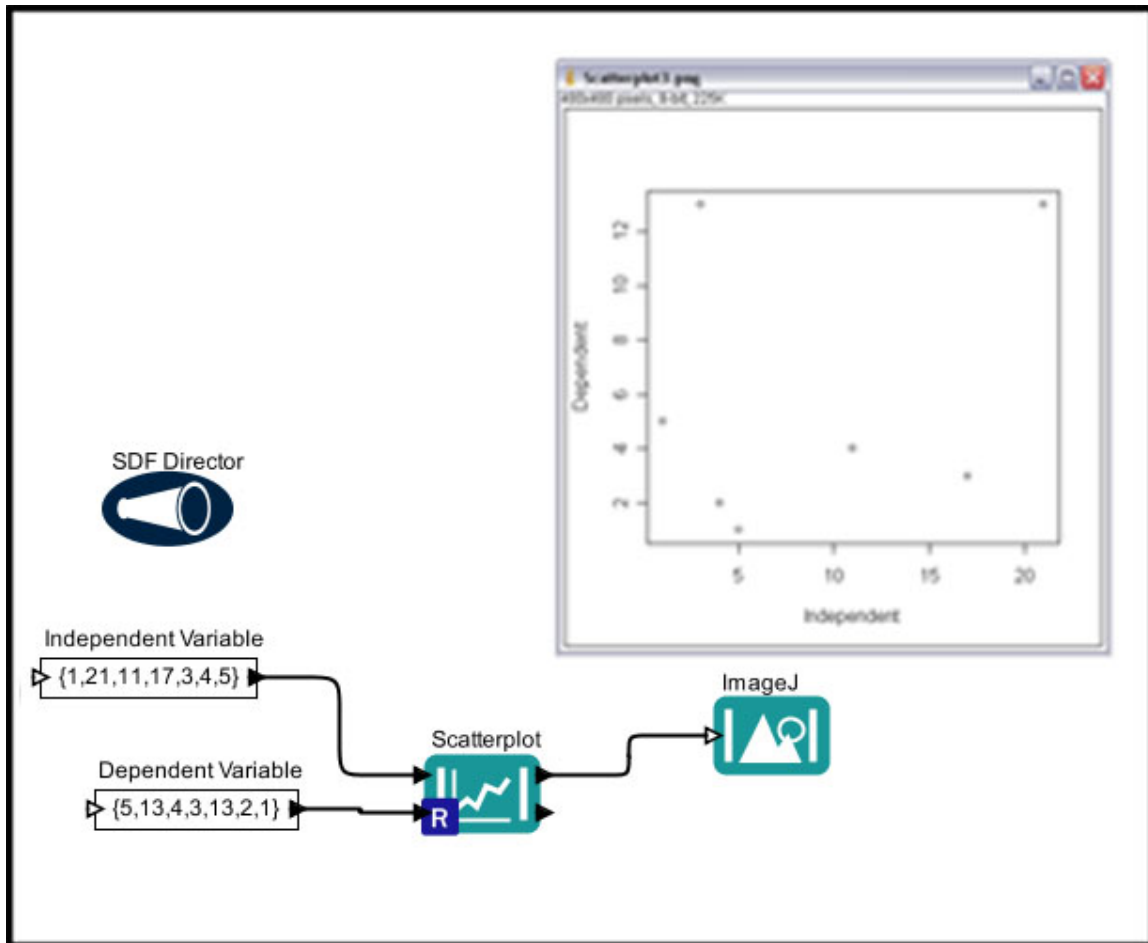

Figure C.46: Using the *Scatterplot* actor.

The axis labels in *Figure C.46* are the generic names of the actor's two input ports: "Independent" and "Dependent".

C.5.7.13 Summary

The *Summary* actor calculates summary statistics (e.g., mean, maximum, minimum, standard deviation, or median) of a variable (e.g., height) with respect to one or more factors (e.g., classroom and sex). Up to five factors can be input using the ports on the left of the actor. Factors are input as arrays (if using an EML data set, select "As Column Vectors" as the data output format).

On Mac systems, the *Summary* actor will open the system's default text-editor to display a table of the calculated statistics. On Windows systems, the results can be found in the Kepler cache, saved to a file called "summary.txt."

The workflow in *Figure C.47* uses a *Summary* actor to calculate the mean of crab hole density with respect to site and zone. A *StringConstant* actor (*Summary operation*) specifies the type of operation to perform (mean).

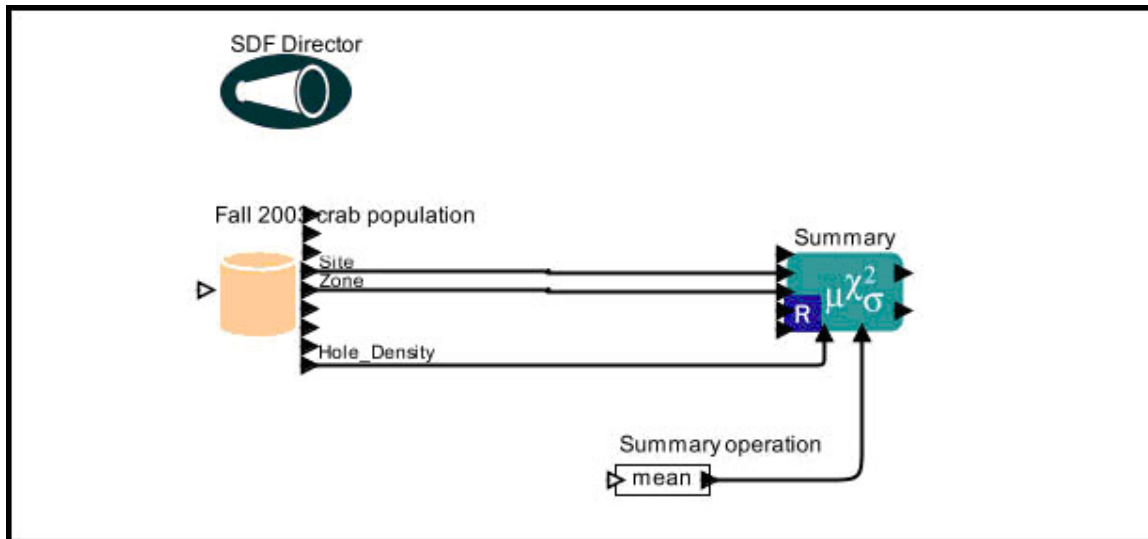

Figure C.47: Using the *Summary* actor to calculate the mean of a variable with respect to several factors.

The workflow uses an EML data source, "Fall 2003 crab population," and the data output format is set to "As Column Vector." Note that the variable is input at the bottom of the *Summary* actor and the factors are input into the ports on the actor's left. The summary operation is specified using R-language syntax (e.g., *mean*, *max*, *min*, *sd*, *median*, etc.)

The *Summary* actor performs the summary and saves a tab-delimited table of the results to a text file called "summary.txt" in the R working directory (the .kepler cache, by default). On a Mac system, the actor opens the table in the default text-editing program.

C.5.7.14 SummaryStatistics

The *SummaryStatistics* actor accepts an array of values and calculates their mean, standard deviation, and variance (*Figure C.48*). The actor outputs both a graphical and textual representation of the summary analysis.

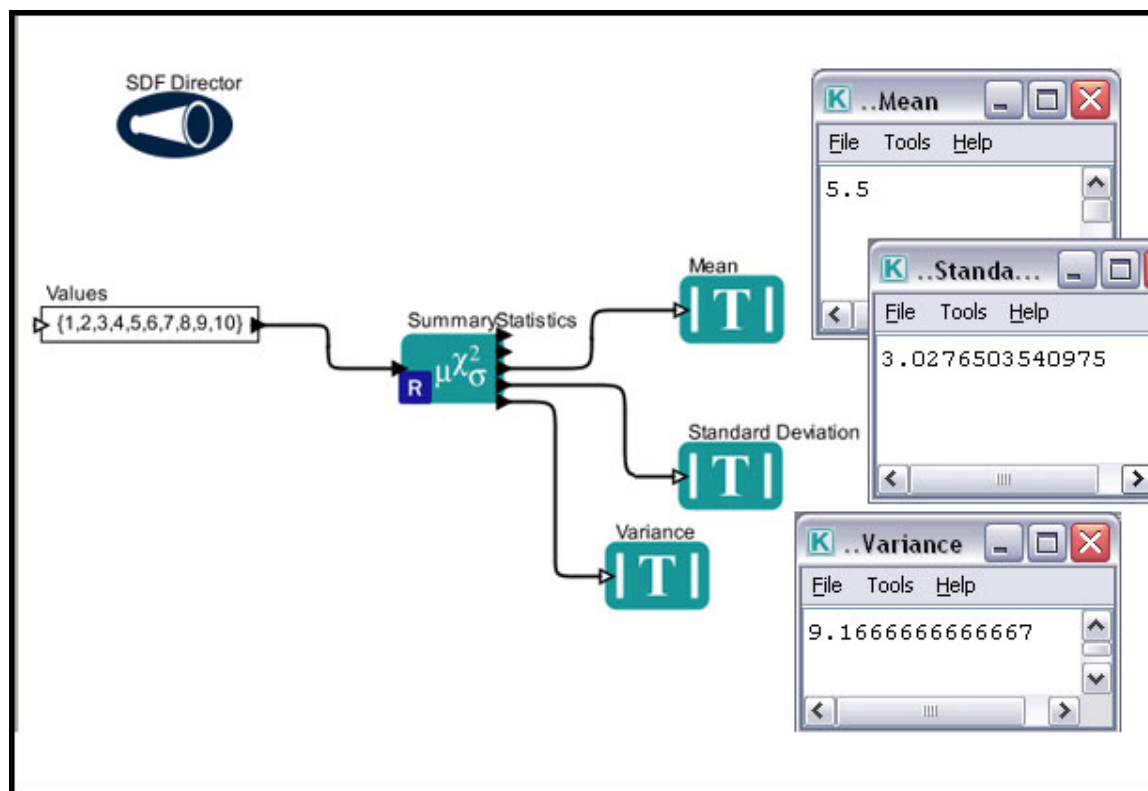

Figure C.48: Using the *SummaryStatistics* actor.

11. Appendix: Glossary

actor

An actor is a workflow component representing a service or data. Actors can be dragged and dropped from the Components and Data Access area onto the Workflow canvas, where they can be customized via parameters, and connected to other actors via ports.

Antelope

Antelope is a system, originally developed by Boulder Real-Time Technologies (<http://www.brnt.com/>), for archiving and distributing environmental monitoring information, such as data from a remote camera. Antelope ORBs act as sources (and sinks) for real-time data, such as waveforms and events.

array token

An array is a data structure consisting of elements that can be identified by a key (or index). The first item in an array has a key of 0, the second 1, etc. Arrays in Kepler are denoted with curly braces, e.g. {1,2,3,4,5}

ARC

ARC is an information format for geospatial data.

Babel

Babel is an application designed to convert file formats used in molecular modeling and computational chemistry. For more information about Babel, see <http://smog.com/chem/babel/>.

Boolean token

The Boolean token can have one of two values: true or false (represented by 1 or 0, respectively)

channel

Data flows between workflow components via channels or "links" between components.

CIPRES

The CIPRES (Cyberinfrastructure for Phylogenetic Research) project works to enable large-scale phylogenetic reconstructions that facilitate analyses of datasets containing large numbers of bio molecular sequences. For more information about CIPRES, see <http://www.phylo.org/>

complex number

A complex number consists of a real and imaginary part. In Kepler, the imaginary component of a complex number is designated with an i or j (e.g., 6+7i)

composite actor

A composite actor, also called a nested or sub-workflow, is a collection or set of actors bundled together to perform a more complex operation. Composite actors can contain a director, or they can "inherit" their director from a containing workflow. Composite actors that have a director are called opaque.

CORBA service

CORBA services, much like Web services, are computer programs that run on a remote host and communicate using a standardized protocol that allows them to interoperate.

director

A director controls (or directs) the execution of a workflow, just as a film director oversees a cast and crew. The actors take their execution instructions from the director. In other words, actors specify what processing occurs while the director specifies when it occurs. Every workflow must have a director.

double

A double represents a floating point number (e.g., 1.345) with "double precision." The data can contain about twice the number of significant digits as a float, which is a single-precision data type that is less precise than a double, but also requires less memory.

EarthGrid

The EarthGrid is a distributed network providing scientists access to ecological, biodiversity, and environmental data and analytic resources, such as data, metadata, analytic workflows, and processors.

ESRI ASCII Grid

The ESRI ASCII Grid format is a raster format used by Kepler to pass data between various actors. For more information about this format, see <http://docs.codehaus.org/display/GEOTOOLS/ArcInfo+ASCII+Grid+format>.

ESRI Shape file

ESRI shape files contain a set of vector coordinates that represent the non-topological geometry of a data set. For more information about ESRI shape files, see <http://www.esri.com/library/whitepapers/pdfs/shapefile.pdf>

Expression language

Kepler uses the Ptolemy expression language to specify and evaluate algebraic expressions (e.g., the value of a parameter or the Expression actor). For more information about the expression language, see <http://www.eecs.berkeley.edu/Pubs/TechRpts/2007/EECS-2007-7.html>

fixed-point number

A fixed-point number is a number in which the position of the decimal point is constant. U.S. currency can be represented by a fixed-point number that has two digits to the right

of the decimal point, for example. Fixed point numbers in Kepler are represented in the following way: `fix(value, integerBits, fractionBits)`.

floating-point number

A floating-point number can contain a decimal point in any position (e.g., 12.34 or .0093).

float

A float represents a floating point number (e.g., 1.345) with "single precision." The data type requires less memory and is less precise than a double (which also represents a floating point number). The Kepler expression language does not support the float data type. Use double or integer types instead.

GAMA

GAMA is a system for securely creating and managing Grid accounts. For more information about GAMA, see:

http://www.geongrid.org/index.php/home/researchpubs/GAMA_Grid_Account_Management_Architecture/

GAMESS

GAMESS (General Atomic and Molecular Electronic Structure System) is a program that can perform a broad range of quantum chemical computations. For more information about GAMESS, see <http://www.msg.ameslab.gov/GAMESS/>

GARP

GARP (Genetic Algorithm for Rule Set Production) is a genetic algorithm that creates an ecological niche model representing the environmental conditions where a species would be able to maintain populations. For more information about GARP, see <http://www.lifemapper.org/desktopgarp/>.

GDAL

GDAL (Geospatial Data Abstraction Library) is a library used to translate raster geospatial data formats (e.g., GeoTIFF, ASCII Grid, or GRASS Raster). For more information about GDAL, see <http://www.gdal.org/>.

general data type

The general data type is the most inclusive of the types. A port assigned type "general" can accept data of all types (array, string, matrix, etc)

GEON

GEON (Geosciences Network) is a distributed infrastructure for Geoscience research and education. For more information about GEON, see <http://www.geongrid.org/>.

Globus

Globus is an open source software toolkit used for building Grid systems, which help

people share computing power, databases, and other tools. For more information about Globus, see <http://www.globus.org>.

GML

GML is an XML-based encoding for geographic information. For more information about GML, see <http://www.w3.org/Mobile/posdep/GMLIntroduction.html>

GRASS

GRASS is an open source software toolkit used to manage and analyze geospatial data and produce graphics and maps. For more information about GRASS, see <http://grass.itc.it/>.

grid

The Grid consists of geographically distributed resources (computers or scientific instruments, for example) that can be easily accessed, allowing users to share computing power, databases, and other tools.

GriddLeS

GriddLeS is a tool used to create Grid workflows that use legacy software, which has not been designed for distributed use. For more information about GriddLes, see <http://www.csse.monash.edu.au/~david/griddles/index.htm>.

ImageJ

ImageJ is an application that can be used to display and process a wide variety of images (tiffs, gifs, jpegs, etc.) For more information about ImageJ, see <http://rsb.info.nih.gov/ij/>.

integer token

The integer token ("int") represents numerical values that have no decimal points (e.g., 11 or -17)

long data type

Integers followed by an "l" or "L" are of type long. The long data type can represent large integers. Float and double data types can also be used: these data types have greater storage capacity than long data types, but less precision/significant digits.

MATLAB

MATLAB is "a high-level technical computing language and interactive environment for algorithm development, data visualization, data analysis, and numeric computation." For more information about MATLAB, see <http://www.mathworks.com/products/matlab/description1.html>.

matrix token

A matrix contains data that can be referenced by row and column. Matrices in Kepler are specified with brackets. Commas separate row elements and semicolons separate rows. For example, a 1x3 matrix would be represented as [1,2,3]. A 2x2 matrix would be represented by [1,2;3,4]

MoML

MoML (Modeling Markup Language) is an XML format used to store workflows. For more information about MoML, see

<http://ptolemy.eecs.berkeley.edu/papers/05/ptIIIdesign1-intro/ptIIIdesign1-intro.pdf>

Nimrod

Nimrod is an application that allows computations to be run on the Grid. For more information about Nimrod, see

<http://www.csse.monash.edu.au/~davidan/nimrod/nimrodg.htm>

object token

An object token is a data container for an arbitrary Java object (most complex 'things' in Java are objects). These tokens can be used to pass complex Java objects around a Kepler workflow. Object tokens are primarily used for custom workflows with custom actors. Non-programmers will probably not find them very useful.

ORB

An ORB (Object Resource Broker) permits applications, which may be running on different servers or under different operating systems, to exchange and process information.

parameter

Parameters are configurable values that can be attached to a workflow or to individual directors or actors.

PAUP

PAUP is a tool used to infer phylogenetic relationships. For more information about PAUP, see <http://paup.csit.fsu.edu/>

port

Each actor in a workflow can contain one or more ports used to consume or produce data and communicate with other actors in the workflow. Ports can be one of three types: input, output, or input/output. Each port is configured to be either a "singular" or "multiple" port. A single port can be connected to only a single data channel, whereas a multiple port can be connected to multiple channels.

R

R is a language and environment for statistical computing and graphics. For more information about R, see <http://www.r-project.org/>.

record token

A record token consists of named elements and their values. In Kepler, records are specified between curly braces. For example, {a=1, b=2} is a record with two elements, named a and b, with values 1 and 2, respectively.

relation

Relations allow users to "branch" a data flow. Branched data can be sent to multiple places in the workflow.

scalar

The term scalar designates a value that consists only of magnitude (as opposed to a vector, which consists of both a magnitude and direction). In Kepler, scalar values may have any scalar data type: double, int, long, etc.

Soaplab

Soaplab is a set of Web services providing access to (mainly) data analysis applications on remote computers.

SRB

SRB is a Grid storage management system providing data access, transfer, and search functionality, as well as persistent archiving (usually for files). For more information about SRB, see http://www.sdsc.edu/srb/index.php/What_is_the_SRB

string data type

A string is a sequence of characters. Strings are specified with quotation marks. Anything between an open and close "" is interpreted as a string.

token

Data in Kepler is encapsulated and passed between workflow components as tokens. Each token has an assigned data type (int, object, or matrix, for example).

Web service

A Web service is a computer program that runs on a remote host and communicates using a standardized protocol.

workflow

Workflows are a flexible tool for accessing scientific data (streaming sensor data, medical and satellite images, simulation output, observational data, etc.) and executing complex analysis on the retrieved data. Each workflow consists of analytical steps that may involve database access and querying, data analysis and mining, and intensive computations performed on high performance cluster computers.

WSDL

WSDL is a format for describing network services—from simple eBay watcher services to complex distributed applications. For a complete list of registered EBI-registered WSDLs, see <http://www.ebi.ac.uk/soaplab/services>.

XSLT

An XSLT file specifies how an XML document should be transformed. For more information about XSLT, see <http://www.w3.org/TR/xslt>.

